

HOMEOWNERS GUIDE









P50045-G5, P50047-G5,
P50049-G5, P50052-G5

HOMEOWNERS GUIDE

IMPORTANT SAFETY INSTRUCTIONS

**READ AND FOLLOW ALL INSTRUCTIONS
SAVE THESE INSTRUCTIONS**

INSTRUCTIONS PERTAINING TO A RISK OF FIRE, ELECTRICAL SHOCK, OR INJURY TO PERSONS

-  **WARNING:** When using electrical products, basic precautions should always be followed, including the following:
-  **DANGER:** Risk of accidental injury or drowning. Do not permit children to use this unit unless they are closely supervised at all times.
-  **WARNING:** Risk of personal injury. To avoid injury, exercise care when entering or exiting the bath.
-  **WARNING:** Risk of electric shock. Do not permit electric appliances (such as a hair dryer, lamp, telephone, radio, or television) within 5' (1.5 m) of this bath.
-  **WARNING:** The use of alcohol, drugs, or medication can greatly increase the risk of fatal hyperthermia. Prolonged immersion in hot water may induce hyperthermia. Hyperthermia occurs when the internal temperature of the body reaches a level several degrees above the normal body temperature of 98.6°F (37°C). The symptoms of hyperthermia include an increase in the internal temperature of the body, dizziness, lethargy, drowsiness, and fainting. The effects of hyperthermia include: (a) failure to perceive heat, (b) failure to recognize the need to exit the bath, (c) unawareness of impending hazard, (d) fetal damage in pregnant women, (e) physical inability to exit the bath, and (f) unconsciousness resulting in the danger of drowning.
-  **WARNING:** Risk of fetal injury. Pregnant or possibly pregnant women should consult a physician before using the bath.
-  **WARNING:** Risk of hyperthermia or drowning. Do not use the bath immediately following strenuous exercise.
-  **WARNING:** Risk of hyperthermia or drowning. Water temperature in excess of 100°F (38°C) may cause injury. Test and adjust the water temperature before use.
-  **WARNING:** Risk of personal injury. Never drop or insert any object into any opening.

An equipment grounding terminal is provided in the field wiring compartment. To reduce the risk of electric shock, this terminal must be connected to the grounding means provided in the electric supply panel with a conductor equivalent in size to the circuit conductors supplying this bath.

A pressure wire connector is provided on the exterior of the blower motor or control within this unit to permit connection of a bonding conductor between this unit and all other exposed metal in the vicinity, as needed to comply with local requirements.

Use this bath only for its intended purpose as described in this guide. Do not use attachments not recommended by the manufacturer.

HOMEOWNERS GUIDE

IMPORTANT SAFETY INSTRUCTIONS (CONT'D)

The bath must be connected only to a supply circuit that is protected by a Ground-Fault Circuit-Interrupter (GFCI)*. Such a GFCI should be provided by the installer and should be tested on a routine basis. To test the GFCI, press the test button. The GFCI should interrupt power. Press the reset button. Power should be restored. If the GFCI fails to operate in this manner, the GFCI is defective. If the GFCI interrupts power to the bath without the test button being pressed, a ground current is flowing, indicating the possibility of an electric shock. Do not use this bath. Disconnect the bath and have the problem corrected by a qualified service representative before using.

Your new KALLISTA bath has been listed by Underwriter’s Laboratories, ensuring safety for you and your family. This bath also conforms to rigid ANSI and IAPMO standards set within the plumbing industry.

*Outside North America, this device may be known as a Residual Current Device (RCD).

TABLE OF CONTENTS

Important Safety Instructions	2
Table of Contents	3
Thank You For Choosing Kallista	3
Your Kallista Bath with Airjets	4
How to Use This Manual	4
User Keypad And Bath with Airjets Modes/Features	5
Operating Your Bath with Airjets	6
Care and Cleaning Instructions	7
Five-Year Limited Warranty	8
Troubleshooting Procedures	9
Service Parts	15

THANK YOU FOR CHOOSING KALLISTA

We appreciate your commitment to KALLISTA quality products. Please take a moment to review this manual before you install your KALLISTA product. If you encounter any installation or performance problems, please do not hesitate to contact us at the phone number listed at the bottom of the page.

HOMEOWNERS GUIDE

YOUR KALLISTA BATH WITH AIRJETS

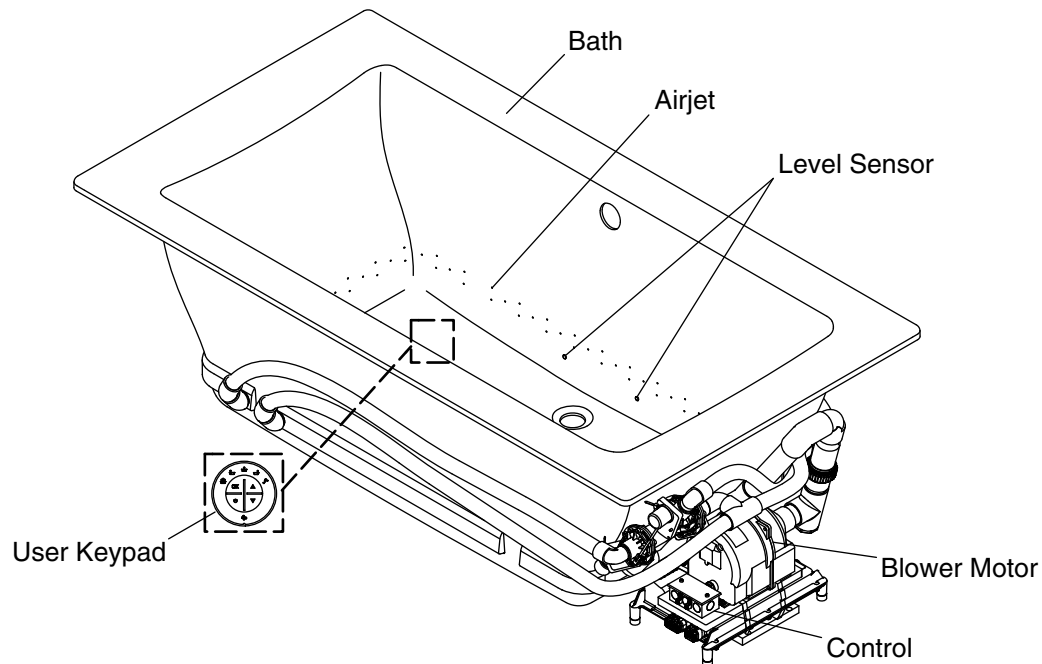

Your new bath with airjets is designed to stimulate, invigorate, and energize your body. You will use the following components:

- Bath** - Allows the bather to relax in comfort while enjoying the air massage.
- User Keypad** - Located within easy reach, the keypad allows you to turn the bath on and off. It also allows you to access the airjet modes and adjust the airflow.
- Airjets** - Holes through which the air flows.
- Level Sensor** - Determines when the bath has been drained and starts the timing for the automatic purge cycle.
- Blower Motor** - Provides quiet, variable speed power to force air through the airjets into the water and create the soothing bubbling action.

HOW TO USE THIS MANUAL

- This manual is designed to help you troubleshoot any problems that may develop with the operation of the bath with airjets.
- If a problem occurs, refer to the "Troubleshooting" section to determine a probable cause.
- Check the "Service Parts" section to determine the part numbers for any replacement parts necessary.
- Use the information on the bottom of the page to contact Kallista to order parts, or for help if you cannot correct the problem.

HOMEOWNERS GUIDE

USER KEYPAD AND BATH WITH AIRJETS MODES/FEATURES

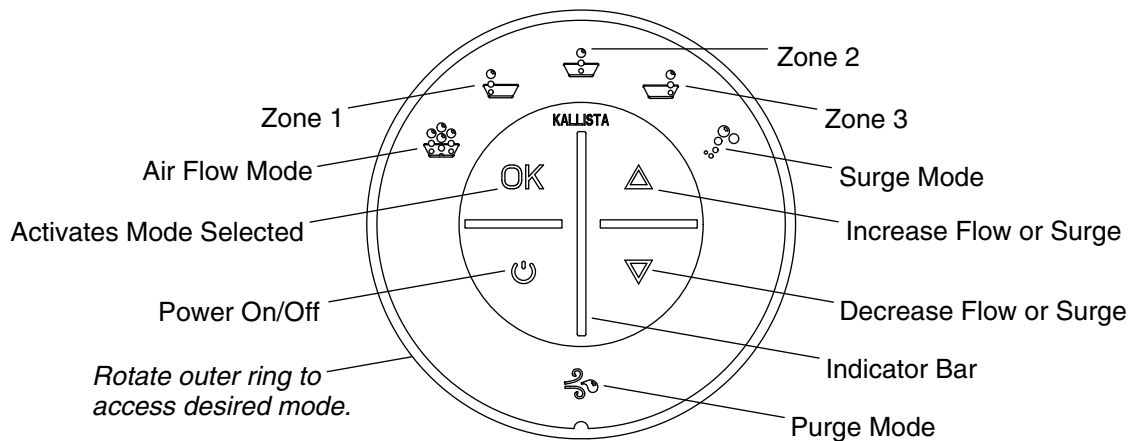
**Rotating Ring Key Pad**

- Power On/Off - Turns the blower motor on and off. Symbols illuminated in blue indicate available modes/features. Modes which are operating will display in green.
- Activate Button - Press "OK" to activate the desired mode. The active mode will flash (green).
- Up Arrow - Increases the air flow when the air flow mode is active. Increases the pulse speed when the surge mode is active.
- Down Arrow - Decreases the air flow when the air flow mode is active. Decreases the pulse speed when the surge mode is active.
- Outer Ring - Rotate the outer ring to the desired mode. The selected mode will flash (blue).
- Indicator Bar - Shows the air flow volume when operating in the air flow mode. Shows the surge speed when operating in the surge mode.
- Purge Mode - Select to initiate the purge mode manually. The purge cycle will not start if there is water in the bath. The purge mode blows any residual water out of the air channels. The blower motor starts and runs at a low speed for about two minutes. An automatic purge cycle occurs when the bath is drained and the water level falls below the level sensors.
- Air Flow Mode - In this mode, air flow is directed through any combination of the airjets in the selected zones. Air flow can be adjusted with the arrow buttons. When the surge mode is selected, the air flow mode stops. When the air flow mode is selected while operating in the surge mode, the surge mode stops.
- Zone 1 - This mode is used to select or deselect the air flow through Zone 1.
- Zone 2 - This mode is used to select or deselect the air flow through Zone 2.
- Zone 3 - This mode is used to select or deselect the air flow through Zone 3.
- Surge Mode - When active, the air flow ramps up from minimum to maximum and then down again to minimum. The surge speed is adjustable between 10 seconds to 60 seconds by using the up or down buttons. The up and down arrow buttons can be used to adjust the surge speed. Zones can be selected or deselected when in the surge mode.

HOMEOWNERS GUIDE

USER KEYPAD AND BATH WITH AIRJETS MODES/FEATURES (CONT'D.)

- ❑ User Keypad “Sleep” Modes - To enhance your bathing experience, the keypad is programmed to darken after approximately 15 seconds of inactivity. Only the last feature selected will remain illuminated. To resume normal operation, press any key or turn the outer ring. Approximately 60 seconds after all equipment is turned off, the keypad will darken completely to conserve power. Press the power button or turn the outer ring to reactivate the keypad.

OPERATING YOUR BATH WITH AIRJETS

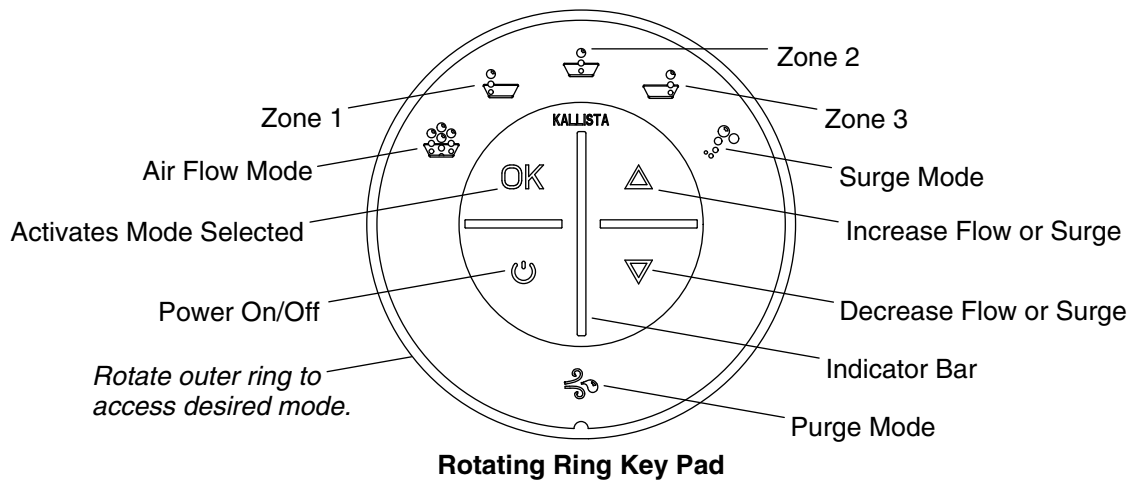

Starting the Unit

If the unit does not function properly, please refer to the “Troubleshooting” section.

- ❑ Close the drain.
- ❑ Fill the bath to a level at least 2” (51 mm) above the top of the airjets.
- ❑ Use your hand to test the water temperature for comfort and safety.
- ❑ Carefully enter the bath basin.
- ❑ Press the On/Off button on the user keypad.
- ❑ Observe that the air system starts and air begins to flow to all zones.
- ❑ If desired, adjust the air flow rate using the up button or the down button.
- ❑ After about 15 seconds, observe that only the last feature selected remains illuminated on the user keypad.

Selecting Air Flow Modes

- ❑ Rotate the outer ring to select a desired mode.
- ❑ Observe that the selected icon is flashing blue.
- ❑ Press the "OK" button to activate the mode.
- ❑ Observe that the active mode flashes green and the mode is implemented.
- ❑ Observe that, after about 15 seconds, the icon stops flashing.

HOMEOWNERS GUIDE

OPERATING YOUR BATH WITH AIRJETS (CONT'D.)

- To turn off a mode, rotate the outer ring until the icon flashes green and then press the "OK" button again.
- The icon will then turn blue indicating the mode is off.

Stopping the Bath

- When ready, press the power button a second time to stop the air system.
- Carefully exit the bath.
- Open the drain to empty the bath.
- Observe that, when the bath drains below the level sensors, the automatic 2-minute purge cycle occurs. The air system operates at a low speed to blow any residual water out of the air channels.
- Observe that, about 60 seconds after shutdown, all user keypad lights extinguish.

Initiating a Manual Purge Cycle

- After stopping the air system and draining the bath, rotate the ring on the user keypad to the purge icon.
- Observe that the purge cycle icon is flashing blue.
- Press the "OK" button once.
- The purge icon flashes green and the mode is implemented. The air system operates at a low speed to blow any residual water out of the air channels.
- After about 2 minutes, the air system stops automatically.

CARE AND CLEANING INSTRUCTIONS

- Do not use powdered cleaners unless the cleaner is fully dissolved in water. Solid substances could block the airjets.
- Do not use full strength bleach or ammonia cleaning solutions. Chemically active cleaning solutions can damage the bath surface.
- Do not use abrasive cleansers or solvents on acrylic surfaces. Abrasive cleaners and solvents can damage the bath surface.
- Wipe out your acrylic bath with a soft cloth after each use.
- Avoid detergents, disinfectants, or cleaning products in aerosol cans.

NOTE: To restore dull or scratched units: Apply white automotive polishing compound with a clean rag. Rub scratches and dull areas vigorously. Wipe off residue. Follow with a coat of white automotive paste wax. Do not wax areas where you walk or stand.

Cleaning Your User Keypad and Remote Control

- Use a soft cloth to wipe the keypad and remote control after each use. If the surface becomes dirty, use a non-abrasive soap and warm water to clean.

HOMEOWNERS GUIDE

CARE AND CLEANING INSTRUCTIONS (CONT'D.)

Maintaining the Airjets

- If cleaning the airjets is required due to hard water deposits, use a small between-the-teeth dental brush and white vinegar. Dip the brush in the vinegar, brush the hole, rinse the brush in clean water, and then use the wet rinsed brush to rinse the hole.
- Fill the bath with water to the top row of airjets. Drain the bath and press the purge button.

Flushing your Airbath System

- Flush your whirlpool system twice a month or more, depending upon usage.
- Fill bath with water one inch above the top of all airjets.
- While bath is filling, carefully add one cup of bleach to the water.
- Let sit for 10-15 minutes.
- Drain the water, run the purge cycle and rinse any debris from the bath.
- Clean bath surfaces as needed with recommended cleaners.
- Dry the bath with a clean, soft towel.

FIVE-YEAR LIMITED WARRANTY

All Kallista products carry Kallista's five-year warranty unless otherwise noted.*

Kallista's products are warranted to be free of defects in material and workmanship for five years from the date of installation.

Kallista will, at its election, repair, replace, or make appropriate adjustment where Kallista inspection discloses any such defects occurring in normal usage within five (5) years after installation. Kallista is not responsible for removal or installation costs. Damages due to improper handling, installation or maintenance are not considered manufacturing defects and are not covered by this warranty. This warranty is valid for the original consumer purchaser only. Use of in-tank toilet cleaners will void the warranty.

To obtain warranty service, contact your Kallista Authorized Showroom.

IMPLIED WARRANTIES INCLUDING THAT OF MERCHANTABILITY AND FITNESS FOR A PARTICULAR PURPOSE ARE EXPRESSLY LIMITED IN DURATION TO THE DURATION OF THIS WARRANTY. KALLISTA AND/OR SELLER DISCLAIMS ANY LIABILITY FOR SPECIAL, INCIDENTAL, OR CONSEQUENTIAL DAMAGES.

Some states/provinces do not allow limitations on how long an implied warranty lasts, or the exclusion or limitation of special, incidental or consequential damages, so these limitations and exclusions may not apply to you. This warranty gives you specific legal rights. You may also have other rights which vary from state/province to state/province.

This is Kallista's exclusive written warranty.

* Kallista's Hampstead and Stafford vitreous products, stainless steel accessories, and wooden accessories carry a one-year Limited Warranty.

HOMEOWNERS GUIDE

TROUBLESHOOTING PROCEDURES

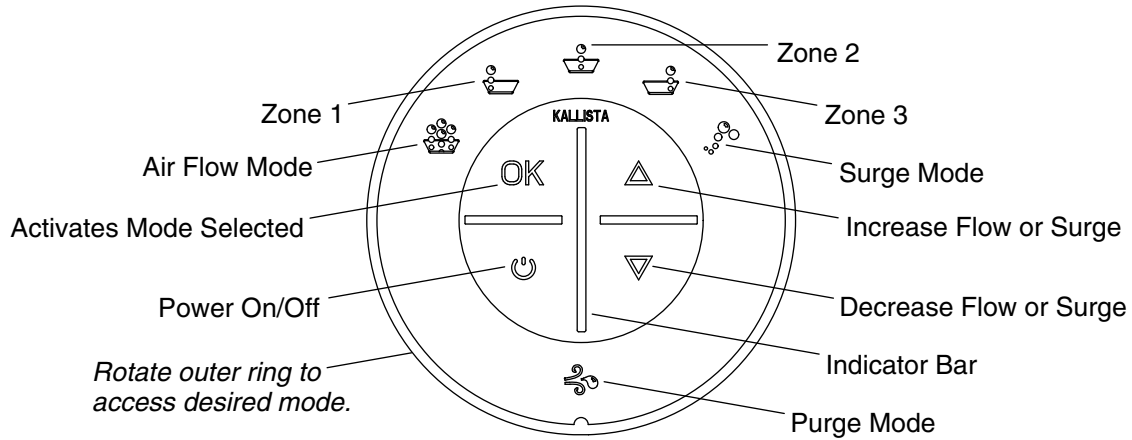

Rotating Ring Key Pad

This troubleshooting guide is for general aid only. A Kallista Authorized Service Representative or qualified electrician should correct all electrical problems. For warranty service, call 1-888-452-5547.

Troubleshooting the Bath with Airjets System

Symptoms	Probable Causes	Recommended Action
1. User keypad does not illuminate when power button is pressed or the outer ring is rotated.	A. No power to control.	A. Check wiring and connect power.
	B. Ground-Fault Circuit-Interrupter (GFCI) or Residual Current Device (RCD) tripped.	B. Reset GFCI or RCD. If it trips again, refer to "Ground-Fault Circuit-Interrupter (GFCI) or Residual Current Device (RCD) trips when bath with airjets is turned on".
	C. Wiring harness from user keypad to control is loose, disconnected or damaged.	C. Check wiring for proper connections. Replace the wiring harness if necessary. Refer to your installer or wholesale dealer.
	D. User keypad does not work.	D. Replace the user keypad. Refer to your installer or wholesale dealer.
	E. Control does not work.	E. Replace the control. Refer to your installer or wholesale dealer.

HOMEOWNERS GUIDE

Symptoms	Probable Causes	Recommended Action
2. Ground-Fault Circuit-Interrupter (GFCI) or Residual Current Device (RCD) trips when bath with airjets is turned on.	A. Electrical harness is wet or damaged.	A. Check for wet connections. Dry the connections and repair the leak. Check for insulation or connector damage. Replace the harness if damaged. Refer to your installer or wholesale dealer.
	B. Electrical wiring to the bath junction box is wet or damaged.	B. Have a qualified electrician diagnose and correct the problem in accordance with applicable building and electrical codes.
	C. Electrical wiring to the bath power cord is wet or damaged.	C. Have a qualified electrician diagnose and correct the problem in accordance with applicable building and electrical codes.
	D. Blower motor is shorted internally.	D. Replace the blower motor. Refer to your installer or wholesale dealer.
	E. Control is shorted internally.	E. Replace the control. Refer to your installer or wholesale dealer.
3. User keypad is illuminated, but does not respond to buttons or outer ring.	A. Control program is locked.	A. Reset GFCI or RCD.
	B. P5 plug assembly harness from user keypad to control is loose, disconnected, or damaged.	B. Check wiring for proper connections. Replace the wiring harness if necessary. Refer to your installer or wholesale dealer.
	C. User keypad does not work.	C. Replace the user keypad. Refer to your installer or wholesale dealer.
	D. Control does not work.	D. Replace the control. Refer to your installer or wholesale dealer.

HOMEOWNERS GUIDE

Symptoms	Probable Causes	Recommended Action
4. Blower motor will not start.	A. Power cord from blower motor to control is loose, disconnected, or damaged.	A. Check wiring for proper connections.
	B. Blower motor does not work.	B. Replace the blower motor. Refer to your installer or wholesale dealer.
	C. Control does not work.	C. Replace the control. Refer to your installer or wholesale dealer.
5. Blower motor stops running and will not immediately restart. Keypad is illuminated.	A. Blower motor overheated and protection device activated.	A. Check for blockage at motor vents. Remove blockage and allow motor to cool. Refer to dealer or wholesale distributor. Otherwise, refer to "User keypad is illuminated, but does not respond to buttons or outer ring. Blower motor will not start."
6. Blower motor starts, some but not all airjets are bubbling.	A. Blower motor speed is too low.	A. Increase speed setpoint to blower motor.
	B. Blower motor inlet is blocked.	B. Clean blower motor inlet.
	C. Blower motor does not work.	C. Replace the blower motor. Refer to your installer or wholesale dealer.
	D. Blower motor discharge is blocked.	D. Check blockage.
	E. Check valve does not work.	E. Replace the check valve. Refer to your installer or wholesale dealer.
	F. Air jets are clogged.	F. Use a small between-the-teeth dental brush and white vinegar. Dip the brush in the vinegar, brush the hole, rinse the brush in clean water, and then use the wet rinsed brush to rinse the hole.

HOMEOWNERS GUIDE

Symptoms	Probable Causes	Recommended Action
7. Blower motor runs but no air bubbles are formed.	A. Blower motor inlet is blocked.	A. Clean blower motor inlet.
	B. Air jets are clogged.	B. Use a small between-the-teeth dental brush and white vinegar. Dip the brush in the vinegar, brush the hole, rinse the brush in clean water, and then use the wet rinsed brush to rinse the hole.
	C. Check valve does not work.	C. Replace the check valve. Refer to your installer or wholesale dealer.
	D. Blower motor does not work.	D. Replace the blower motor. Refer to your installer or wholesale dealer.
	E. Control does not work.	E. Replace the control. Refer to your installer or wholesale dealer.
8. Blower motor operates, air bubbles are formed, zone controls work, but variable speed feature does not work.	A. Blower motor inlet is blocked.	A. Clean blower motor inlet.
	B. Loose, disconnected, or damaged wiring harness.	B. Check wiring for proper connections. Replace the wiring harness if necessary. Refer to your installer or wholesale dealer.
	C. User keypad does not work.	C. Replace the user keypad. Refer to your installer or wholesale dealer.
	D. Blower motor does not work.	D. Replace the blower motor. Refer to your installer or wholesale dealer.
	E. Control does not work.	E. Replace the control. Refer to your installer or wholesale dealer.

HOMEOWNERS GUIDE

Symptoms	Probable Causes	Recommended Action
9. Blower motor won't turn off when the power button on user keypad is pressed.	A. User keypad does not work.	A. Replace the user keypad. Refer to your installer or wholesale dealer.
	B. Loose, disconnected, or damaged wiring harness.	B. Check wiring for proper connections. Replace the wiring harness if necessary. Refer to your installer or wholesale dealer.
	C. Control does not work.	C. Replace the control. Refer to your installer or wholesale dealer.
10. A zone does not produce air bubbles but another zone operates normally.	A. Zone is not selected.	A. Select the zone per the instructions in the "Confirm Proper Operation" section.
	B. Butterfly valve does not work.	B. Replace the butterfly valve. Refer to your installer or wholesale dealer.
	C. Loose, disconnected, or damaged wiring harness.	C. Check wiring for proper connections. Replace the wiring harness if necessary. Refer to your installer or wholesale dealer.
	D. User keypad does not work.	D. Replace the user keypad. Refer to your installer or wholesale dealer.
	E. Control does not work.	E. Replace the control. Refer to your installer or wholesale dealer.
11. Surge mode does not work.	A. User keypad does not work.	A. Replace the user keypad. Refer to your installer or wholesale dealer.
	B. Control does not work.	B. Replace the control. Refer to your installer or wholesale dealer.

HOMEOWNERS GUIDE

Symptoms	Probable Causes	Recommended Action
12. Water spillage or damage observed under the bath.	A. Drain or overflow leaking.	A. Repair or replace the drain assembly per the manufacturer's instructions.
	B. Wall, deck, and/or shower door is improperly sealed.	B. Apply silicone sealant at the seams between the bath and the wall, deck, or door.
	C. Cracked acrylic air channels.	C. Refer to the manufacturer.

HOMEOWNERS GUIDE

SERVICE PARTS

Note: All tubing 1" unless otherwise noted.

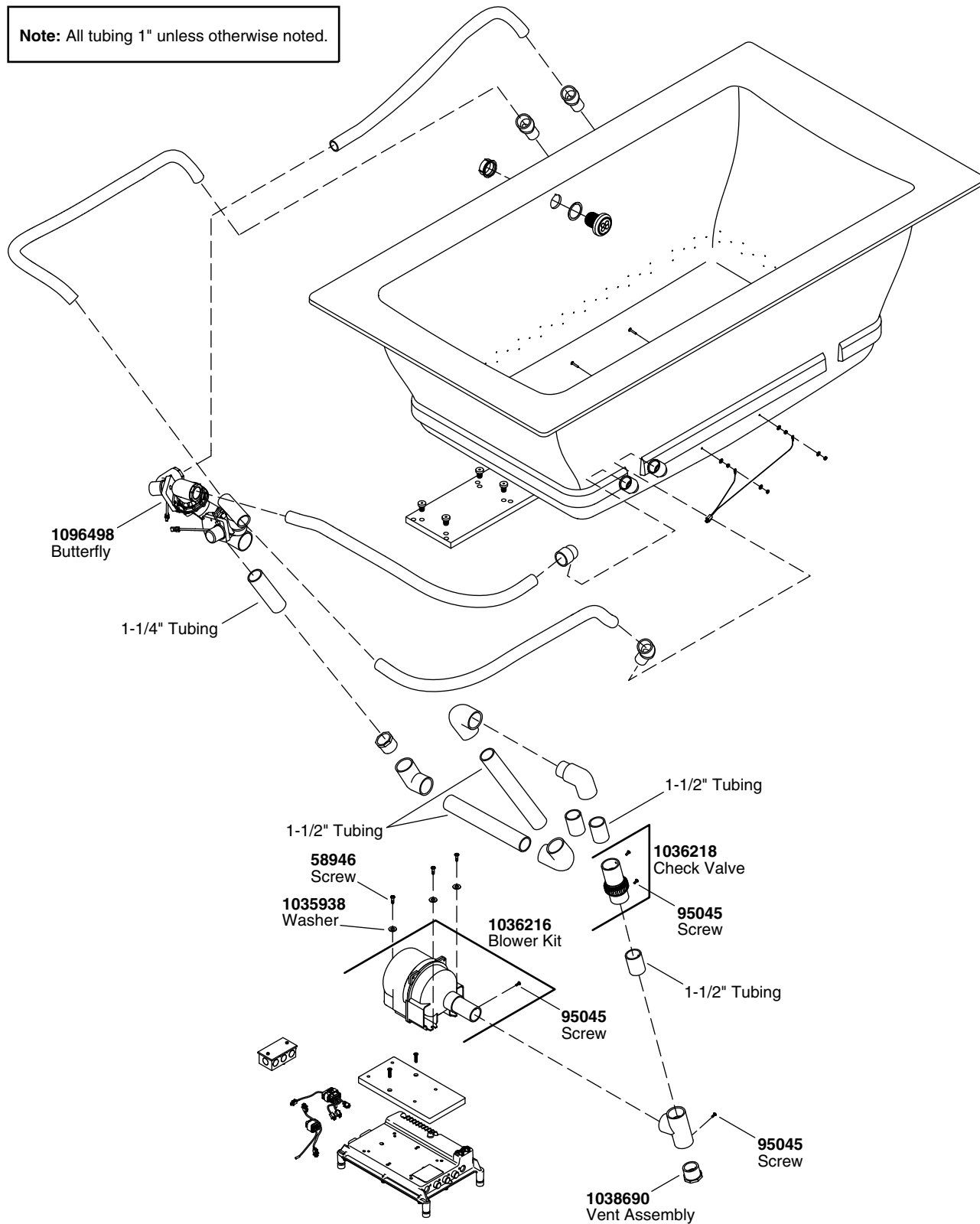

HOMEOWNERS GUIDE

