

# User Guide

Digital Interface and System Controller for DTV+

THE BOLD LOOK  
OF **KOHLER**®

## Table of Contents

Interface and Controller Anatomy	4
System Layout	5
Download/Install Software	6
Initial System Setup	7
Software Updates	8
Shower Configurations – Overview	9
Shower Configuration A – Plumbing Layout 1	11
Shower Configuration A – Plumbing Layout 2	12
Shower Configuration B – Plumbing Layout 1	13
Shower Configuration B – Plumbing Layout 2	14
Shower Configuration B – Plumbing Layout 3	15
Shower Configuration C – Plumbing Layout 1	16
Shower Configuration D – Plumbing Layout 1	17
Shower Configuration D – Plumbing Layout 2	18
Shower Configuration E – Plumbing Layout 1	19
Shower Configuration – Custom	20
Settings Overview	21
Web Settings – System	22
Web Settings – Users	24
Web Settings – Valve	25
Web Settings – Water Outlet Options	27
Web Settings – Default and Maximum Temperature	28
Web Settings – Cold Water	29
Web Settings – Auto Purge	30
Web Settings – Massage	31
Web Settings – Interface	33
Web Settings – Music	34
Web Settings – Room Lighting	35
Web Settings – Rain Panel Lighting	37
Web Settings – Steam	38
Web Settings – About	39
Web Service – Diagnostics	40
Web Service – Updates	41
Interface – Power System On/Off	42
Interface – Turn Features Off	43
Interface Settings – Overview	44
Interface Settings – Display	45
Interface Settings – Auto Return	46
Interface Settings – Start Up	47
Interface Settings – Clean (Lock)	48
Interface Settings – Beep	50
System Settings – Overview	51
System Settings – About	52
System Settings – Update	53
System Settings – Date & Time	54
System Settings – Temperature Unit	55
System Settings – Language	56
Shower – Start	57
Shower – Valve Zones	58
Shower – Auto Purge	59
Shower – Adjust Temperature	60
Shower – Dual Temperature (Multiple Valves Only)	61
Shower – Maximum Cold	62
Shower – Massage Setup	63
Shower – Massage Run	65
Users – Setting Preferences	66
Steam – Setup	67
Steam – Run	68
Steam – Deluge	69

Steam – Power Clean .....	70
Lighting – Room .....	71
Lighting – Ambient Rain Effects .....	73
Lighting – Ambient Rain Color .....	74
Lighting – Ambient Rain Options .....	76
Music – Controls .....	77
Music – Bluetooth Input .....	78
Music – Line-In Input .....	79
Spa – Setup .....	80
Spa – Start .....	81
Spa – Adjust Script .....	83
Time – Minute Timer .....	85
Time – Alarm Clock .....	87
Time – Tub Fill .....	88
User Interface Software .....	89
Compliance .....	90

## Digital Interface

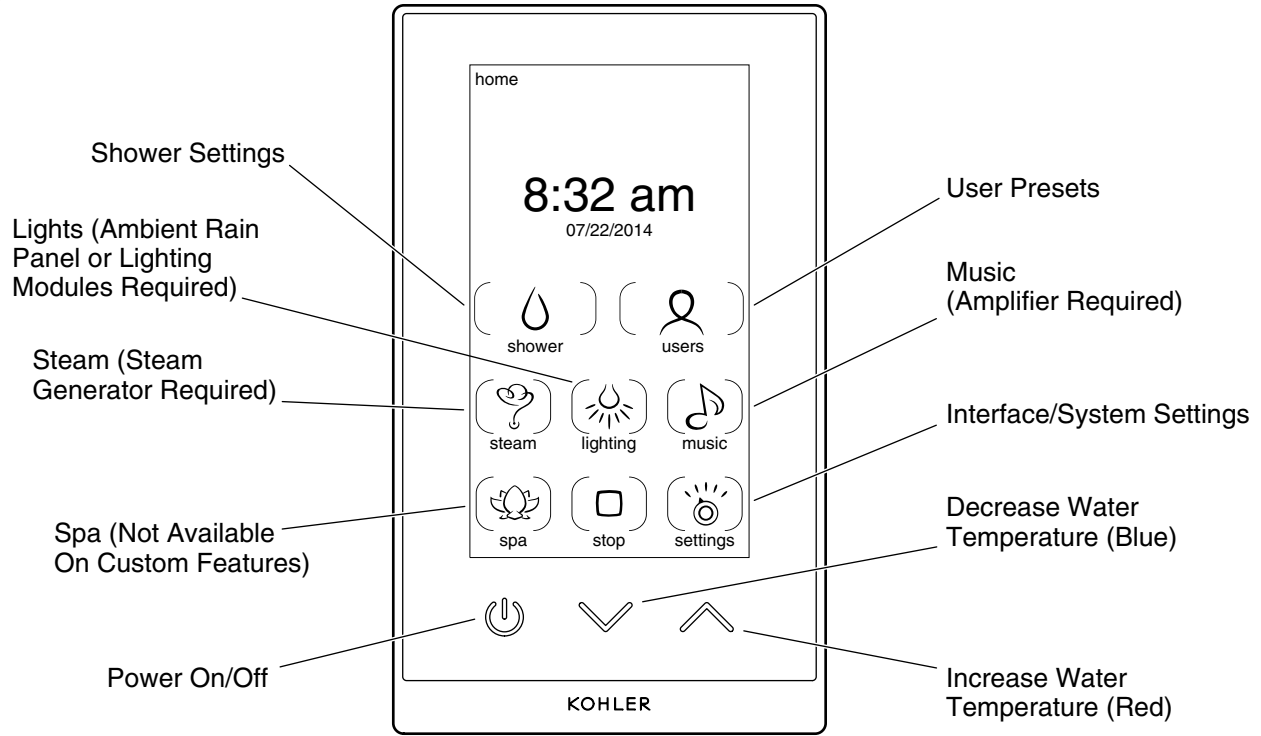

## System Controller

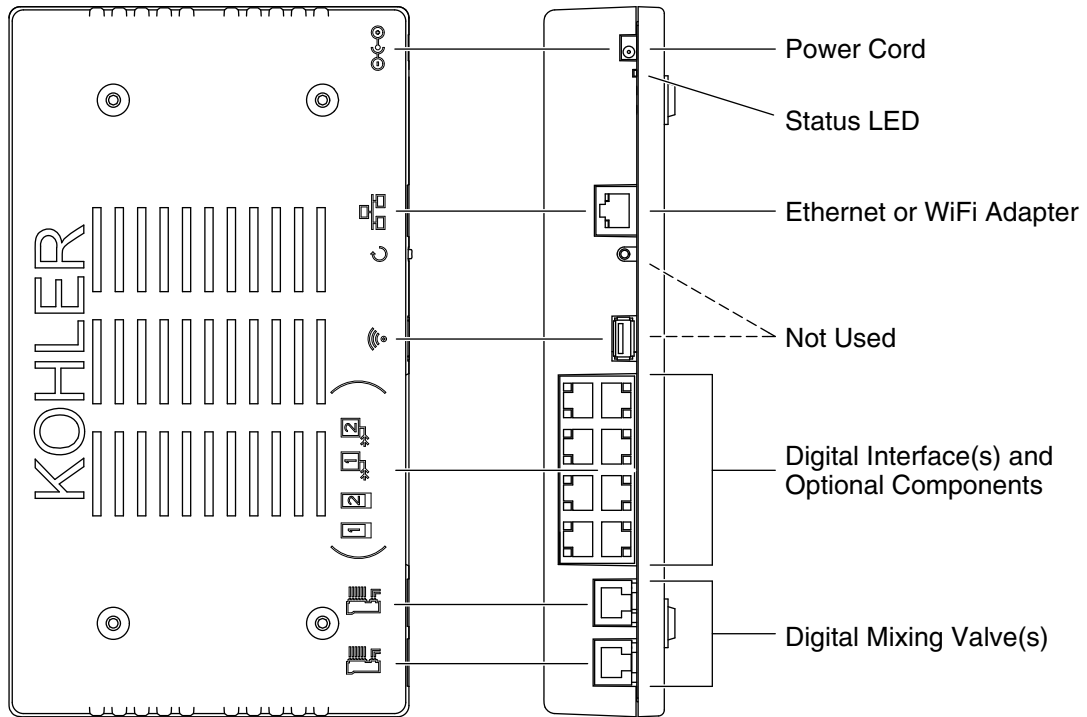

## Interface and Controller Anatomy

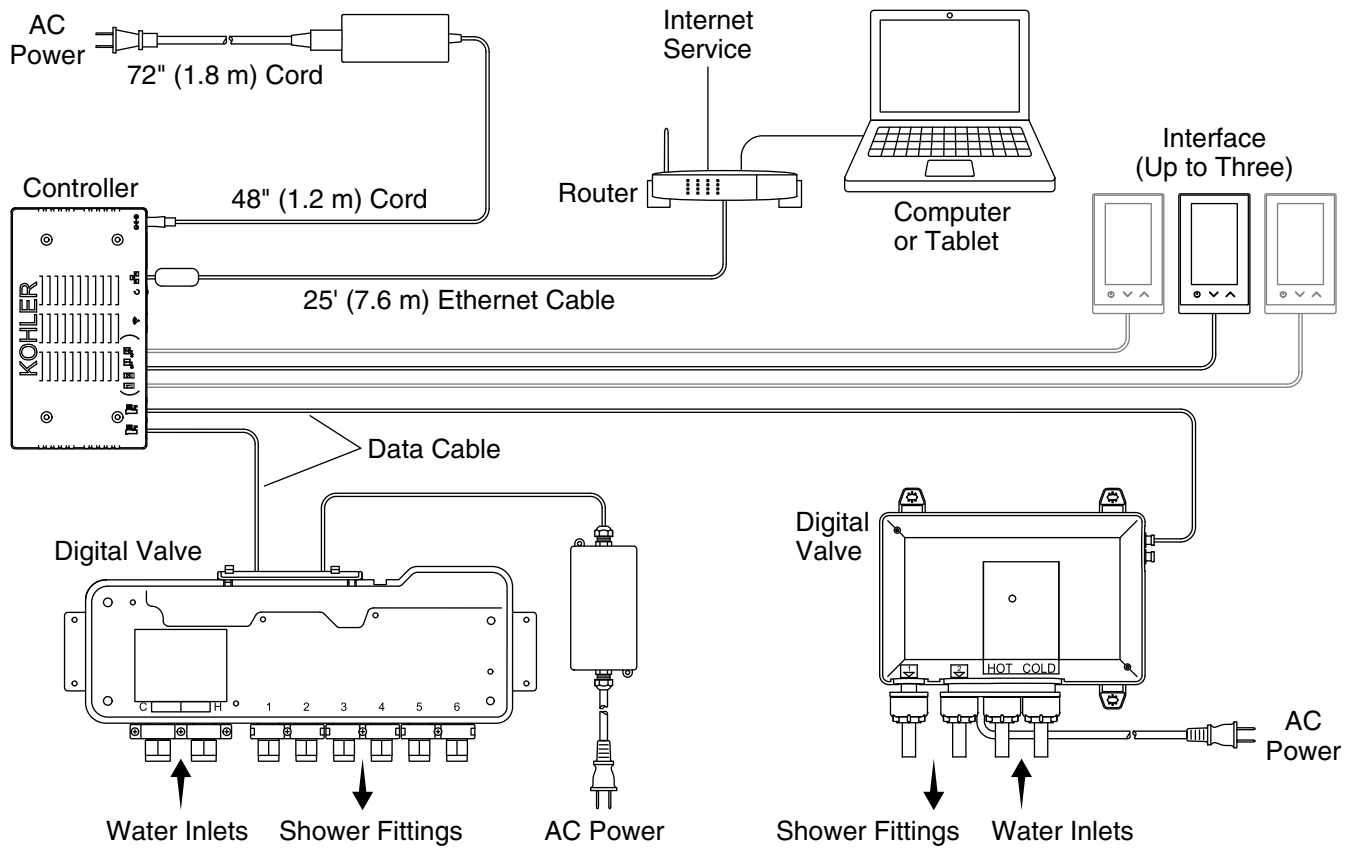

## System Layout

**IMPORTANT!** To access the controller Web pages for system setup, the controller and a computer or tablet must be connected to the same router.

- The controller powers the interface(s) and controls the digital valve(s) and other system components.
- An Ethernet cable is provided with the controller for connection to the router. If the router is not within 25' (7.6 m) of the controller, obtain a longer Ethernet cable or add an extension cable.
- A data cable connects each system component to the controller.
- One interface, located inside the showering enclosure, is required for system operation. Two additional interfaces can be connected to the system.
- One or two valves can be connected to the system. Choose a 2-port, 3-port, or 6-port valve in any combination. Refer to the "Configuration" sections for shower configuration options.
- Refer to the installation guides packed with each product for specific installation needs.

### Before Operating the System for the First Time:

Download and install the latest software for connected components. This may take an hour or more to complete based on system configuration and internet connection speed. **Do not disconnect the power from any components during software download and installation.**

- Refer to the "Download/Install Software" section for download instructions.

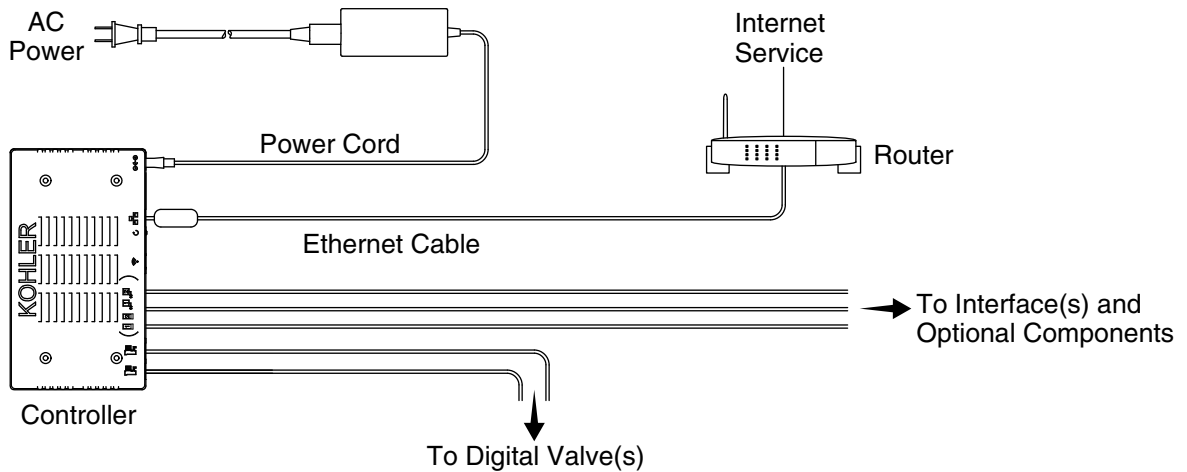

## Download/Install Software

**NOTICE:** Software download and installation may take an hour or more to complete based on system configuration and internet connection speed. **Do not disconnect the power from any components during software download and installation.**

**NOTE:** Internet service is required to receive the latest updates for system components. The components must be connected to the controller prior to software download.

### Initial Download

- Disconnect the power from the controller.
- Make sure all system components are connected to the controller.
- Connect the Ethernet cable from the controller to a router with active internet service.
- Reconnect the power supply to the controller. The controller will communicate with the router to receive an IP address.
- Upon receiving an IP address, the controller will check for software updates for any connected components, and will automatically download the updates. **Do not disconnect the power from any components during software download and installation.**

### Updates

- The controller will check for software updates daily, and will automatically download the software.
- To manually receive software files, contact the Customer Care Center at 1-800-4KOHLER.
- Once software updates are downloaded/received, the updates can be installed from the interface or the controller Web pages. For update installation instructions, refer to the "Software Updates" section.

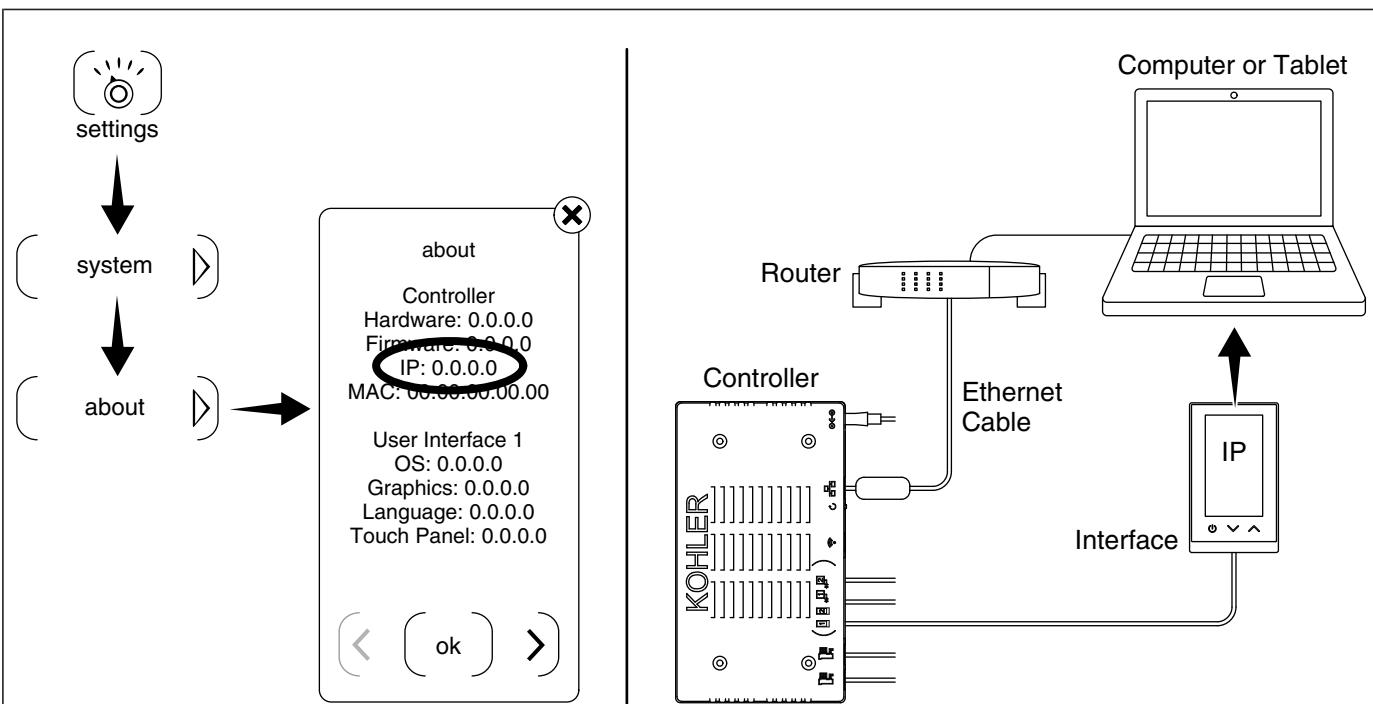

## Initial System Setup

**IMPORTANT!** To access the controller Web pages for system setup, the controller and a computer or tablet must be connected to the same router.

- System setup is configured using the controller Web pages.
- The controller IP address is obtained from the digital interface.

### Obtain the IP Address

- From the [home] screen on the interface, touch the [settings] icon. If an access code is required, enter "1020."
- Select the [system] option, then [about].
- A pop-up window will display current software information for connected components.
- If a valid IP address is not displayed, refer to the "Download/Install Software" section for instructions on connecting to a router.
- Copy the IP address from the displayed information.

### Connect to the Controller Web Pages

- Connect a computer or tablet to the same router as the controller.

**TIP:** For optimal display of the controller Web pages, the recommended website browser is Google Chrome.

- Open a browser window and enter the IP address into the search field.
- The controller Web pages will appear in the browser, providing access to configure system settings.

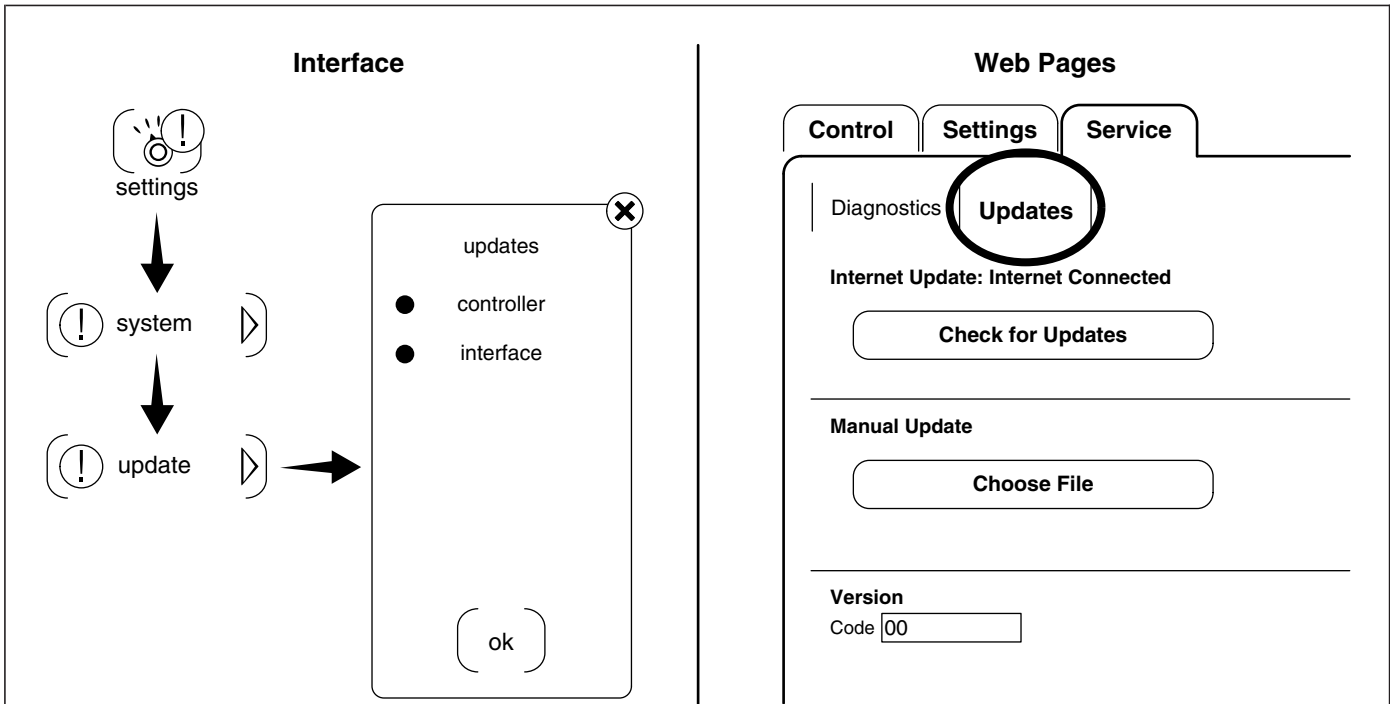

## Software Updates

**NOTE:** The controller will check for software updates daily, and will automatically download the software. Software can also be updated manually from the controller Web pages.

### From the Interface

**NOTE:** If an update is available, an exclamation point will appear on the [settings] icon. Navigate to the [updates] screen by touching the icons that display the exclamation point.

- From the [home] screen, touch the [settings] icon.
- Go to [system], then to [update].
- A pop-up window will indicate if updates are available for any connected system components.

### From the Web Pages

- On a computer or tablet connected to the same router as the controller, open a browser (Google Chrome is recommended) and enter the Web IP address. To obtain the IP address, refer to the "Initial System Setup" section.
- Click on the [Service] tab, then on [Updates].
- Click [Check for Updates] to download the latest software for any connected system components.
- If updates are available, the controller will automatically download the software.



**6-Port Valve  
(K-682-K)**

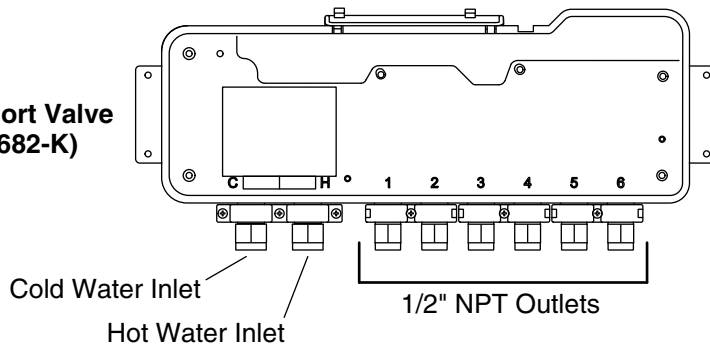

**3-Port Valve  
(K-557-K1)**

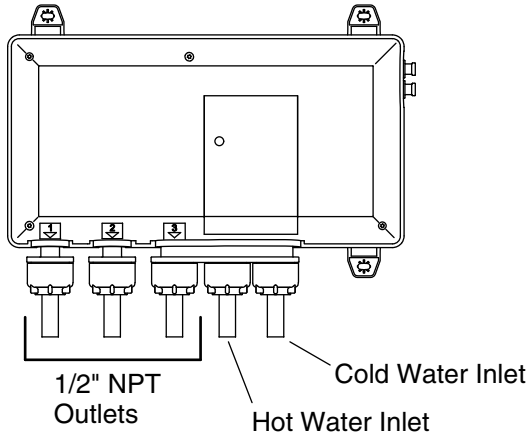

**2-Port Valve  
(K-528-K1)**

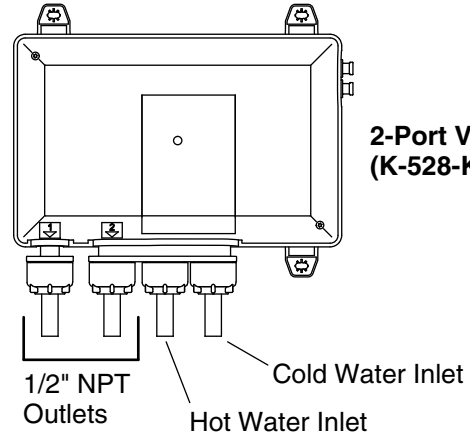

## Shower Configurations – Overview

**NOTICE:** Do not allow any outlet to flow more than 10 gal/min (37.9 l/min).

**IMPORTANT!** To ease setup for a multiple valve system, valve 1 (zone 1) should be connected to the system controller before valve 2 (zone 2). If valve 1 does not appear on the controller Web page before connecting the second valve to the controller, swap the valves by clicking the "Swap Valves 1 and 2" button. Refer to the "Web Settings – Valve" section.

- Shower configurations are available based on the number of valves connected to the controller.
- Any valve outlets that are not used must be capped.
- For optimal valve performance, the water heater should be set at 120°F (49°C). Hot water pressure should be equal to or less than the cold water pressure.
- Showering configurations using large water volumes require supply piping and drain systems that will sufficiently accommodate the actual total flow rate at any one time.
- **Hot water generation:** Use a water heating system capable of handling large flow rates. Tankless (on-demand) water heaters and recirculating pumps may not be adequate for your showering configuration.

### Massage

**IMPORTANT!** For proper function, all shower fittings on the same valve that are enabled with massage must have total equal flow rates. For example, if one valve outlet supplies water to two bodysprays, the total flow rate of both bodysprays must equal the flow rate of a single fitting supplied by a different outlet.

### Spa

## Shower Configurations – Overview (cont.)

**NOTICE:** Custom shower configurations may not allow certain system features to be enabled.

- For the [spa] icon to be displayed on the interface home screen, spa must be enabled on the controller Web pages. To enable the spa feature, refer to the “Web Settings – System” section.
- Use of configurations other than the preprogrammed options will LIMIT preprogrammed spa and massage features.

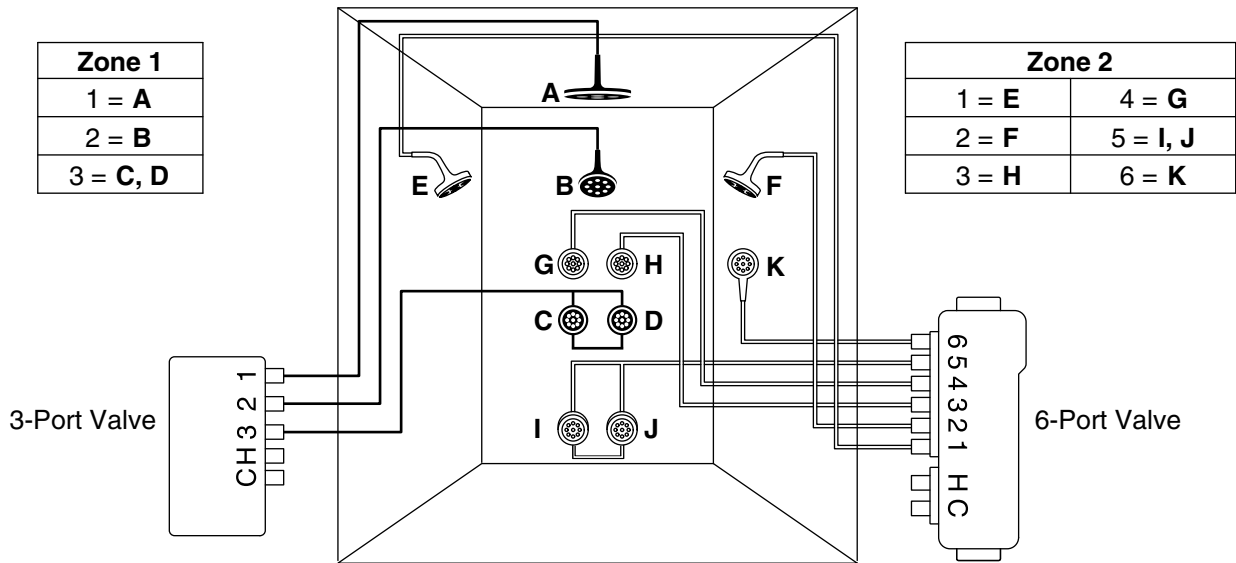

## Shower Configuration A – Plumbing Layout 1

**IMPORTANT!** For proper shower system setup and performance, especially regarding massage and spa function, refer to the "Shower Configurations – Overview" section for important information.

### Valves/Outlets Used

- Three-port valve (zone 1) = 3
- Six-port valve (zone 2) = 6

### Flow Rates

**NOTE:** Water flow rates are calculated below based on nine used outlet ports with equal flow rates. If your fittings have varying flow rates, calculate the total flow rate accordingly.

- Total, with 2.2 gal/min (8.3 l/min) per outlet = **19.8 gal/min (75 l/min)**
- Maximum total, with 2.5 gal/min (9.5 l/min) per outlet = **22.5 gal/min (85.2 l/min)**

### Spa Compatibility

- [warm up]
- [cool down]
- [relax]
- [focus]
- [restore]
- [breathe]
- [flex]
- [headaid]

### Steam Compatibility

- [steam coach]
- [detox]
- [repair]

**NOTE:** A pressure balance loop is required when two or more spays are connected to one outlet (C-D) and (I-J).

Zone 1	
1 = A	4 = C
2 = B	5 = Open
3 = D	6 = Open

Zone 2	
1 = E	4 = G
2 = F	5 = I, J
3 = H	6 = K

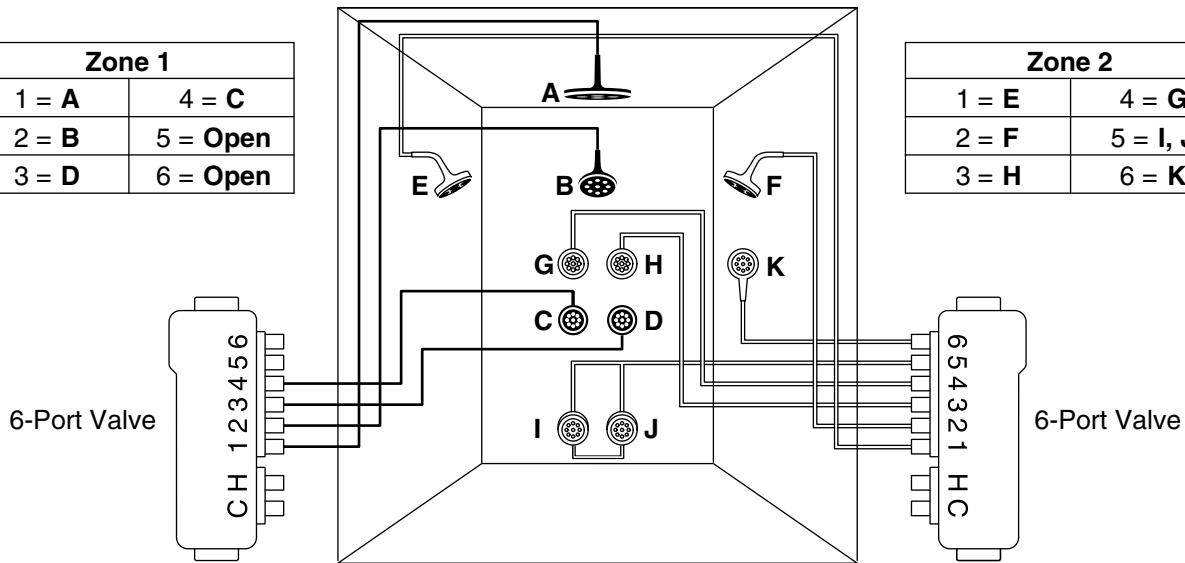

## Shower Configuration A – Plumbing Layout 2

**IMPORTANT!** For proper shower system setup and performance, especially regarding massage and spa function, refer to the "Shower Configurations – Overview" section for important information.

**NOTE:** Any valve outlets that are not used must be capped.

### Valves/Outlets Used

- Six-port valve (zone 1) = 6
- Six-port valve (zone 2) = 4

### Flow Rates

**NOTE:** Water flow rates are calculated below based on 10 used outlet ports with equal flow rates. If additional valve outlets are being used, or your fittings have varying flow, calculate the total flow rate accordingly.

- Total, with 2.2 gal/min (8.3 l/min) per outlet = **22 gal/min (83.3 l/min)**
- Maximum total, with 2.5 gal/min (9.5 l/min) per outlet = **25 gal/min (94.6 l/min)**

### Spa Compatibility

- [warm up]
- [cool down]
- [relax]
- [focus]
- [restore]
- [breathe]
- [flex]
- [headaid]

### Steam Compatibility

- [steam coach]
- [detox]
- [repair]

**NOTE:** A pressure balance loop is required when two or more spays are connected to one outlet (I-J).

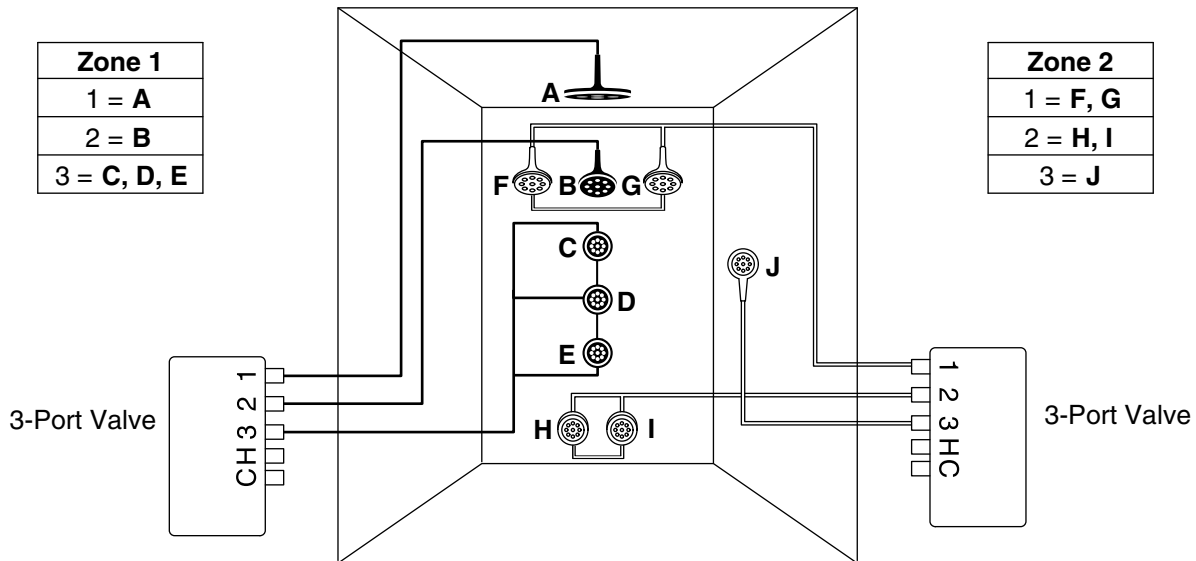

## Shower Configuration B – Plumbing Layout 1

**IMPORTANT!** For proper shower system setup and performance, especially regarding massage and spa function, refer to the "Shower Configurations – Overview" section for important information.

### Valves/Outlets Used

- Three-port valve (zone 1) = 3
- Three-port valve (zone 2) = 3

### Flow Rates

**NOTE:** Water flow rates are calculated below based on six used outlet ports with equal flow rates. If your fittings have varying flow rates, calculate the total flow rate accordingly.

- Total, with 2.2 gal/min (8.3 l/min) per outlet = **13.2 gal/min (50 l/min)**
- Maximum total, with 2.5 gal/min (9.5 l/min) per outlet = **15 gal/min (56.8 l/min)**

### Spa Compatibility

- [warm up]
- [cool down]
- [relax]
- [focus]
- [restore]
- [breathe]
- [flex]
- [headaid]

### Steam Compatibility

- [steam coach]
- [detox]
- [repair]

**NOTE:** A pressure balance loop is required when two or more spays are connected to one outlet (F-G), (C-D-E), and (H-I).

Zone 1	
1 = A	4 = D
2 = B	5 = E
3 = C	6 = Open

Zone 2	
1 = F, G	
2 = H, I	
3 = J	

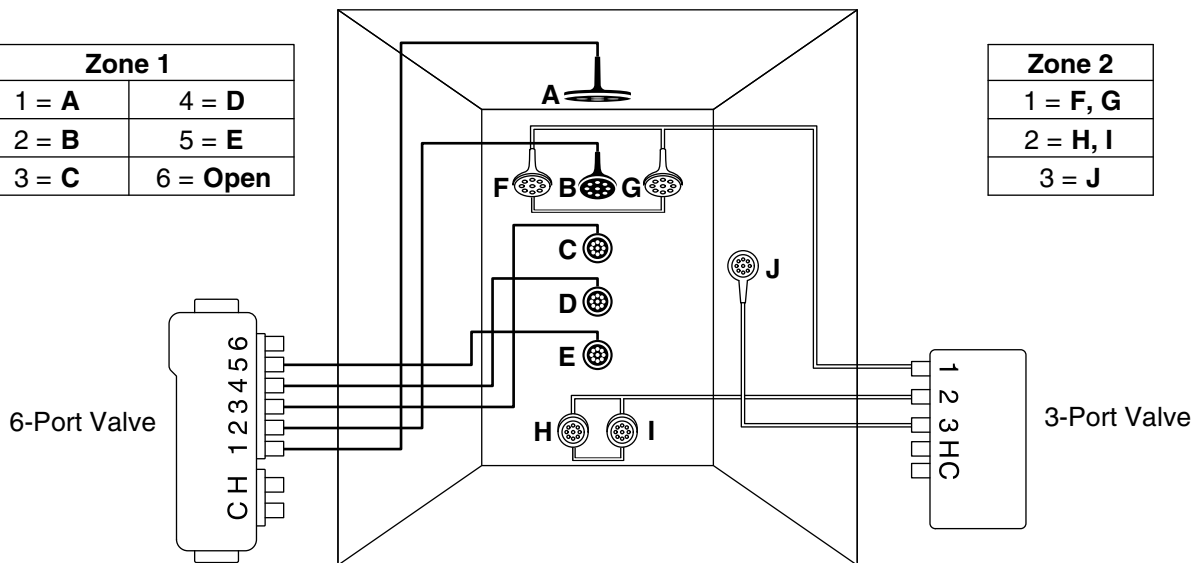

## Shower Configuration B – Plumbing Layout 2

**IMPORTANT!** For proper shower system setup and performance, especially regarding massage and spa function, refer to the "Shower Configurations – Overview" section for important information.

**NOTE:** Any valve outlets that are not used must be capped.

### Valves/Outlets Used

- Six-port valve (zone 1) = 5
- Three-port valve (zone 2) = 3

### Flow Rates

**NOTE:** Water flow rates are calculated below based on eight used outlet ports with equal flow rates. If additional valve outlets are being used, or your fittings have varying flow, calculate the total flow rate accordingly.

- Total, with 2.2 gal/min (8.3 l/min) per outlet = **17.6 gal/min (66.6 l/min)**
- Maximum total, with 2.5 gal/min (9.5 l/min) per outlet = **20 gal/min (75.7 l/min)**

### Spa Compatibility

- [warm up]
- [cool down]
- [relax]
- [focus]
- [restore]
- [breathe]
- [flex]
- [headaid]

### Steam Compatibility

- [steam coach]
- [detox]
- [repair]

**NOTE:** A pressure balance loop is required when two or more spays are connected to one outlet (F-G) and (H-I).

Zone 1	
1 = A	4 = D
2 = B	5 = E
3 = C	6 = Open

Zone 2	
1 = F	4 = I
2 = G	5 = J
3 = H	6 = Open

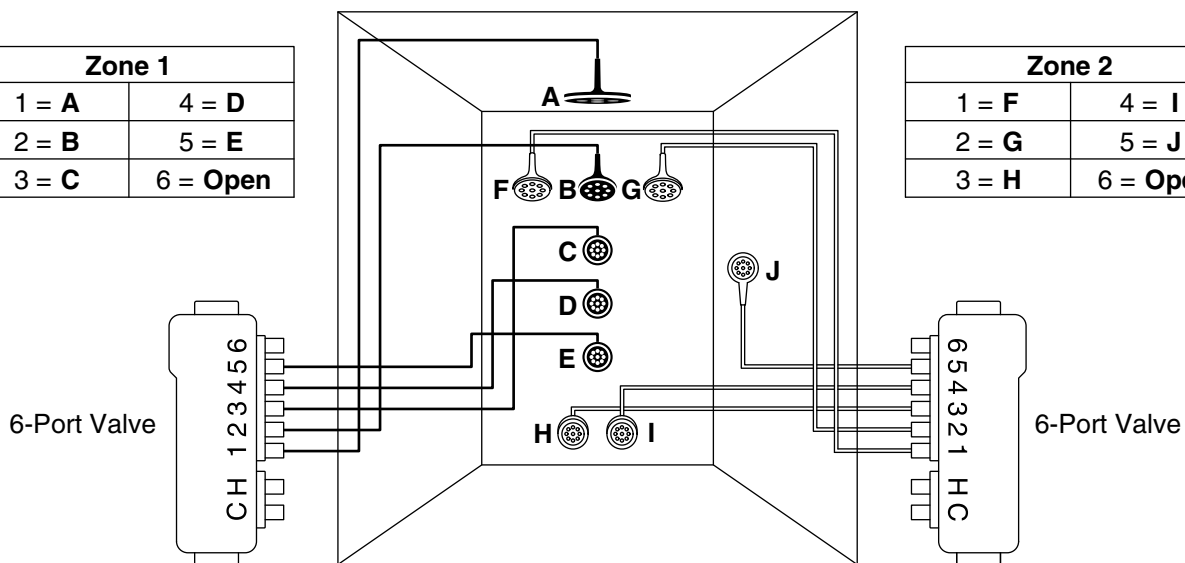

## Shower Configuration B – Plumbing Layout 3

**IMPORTANT!** For proper shower system setup and performance, especially regarding massage and spa function, refer to the "Shower Configurations – Overview" section for important information.

**NOTE:** Any valve outlets that are not used must be capped.

### Valves/Outlets Used

- Six-port valve (zone 1) = 5
- Six-port valve (zone 2) = 5

### Flow Rates

**NOTE:** Water flow rates are calculated below based on 10 used outlet ports with equal flow rates. If additional valve outlets are being used, or your fittings have varying flow, calculate the total flow rate accordingly.

- Total, with 2.2 gal/min (8.3 l/min) per outlet = **22 gal/min (83.3 l/min)**
- Maximum total, with 2.5 gal/min (9.5 l/min) per outlet = **25 gal/min (94.6 l/min)**

### Spa Compatibility

- [warm up]
- [cool down]
- [relax]
- [focus]
- [restore]
- [breathe]
- [flex]
- [headaid]

### Steam Compatibility

- [steam coach]
- [detox]
- [repair]

Zone 1	
1 = A	4 = E, F
2 = B	5 = G, H
3 = C, D	6 = I

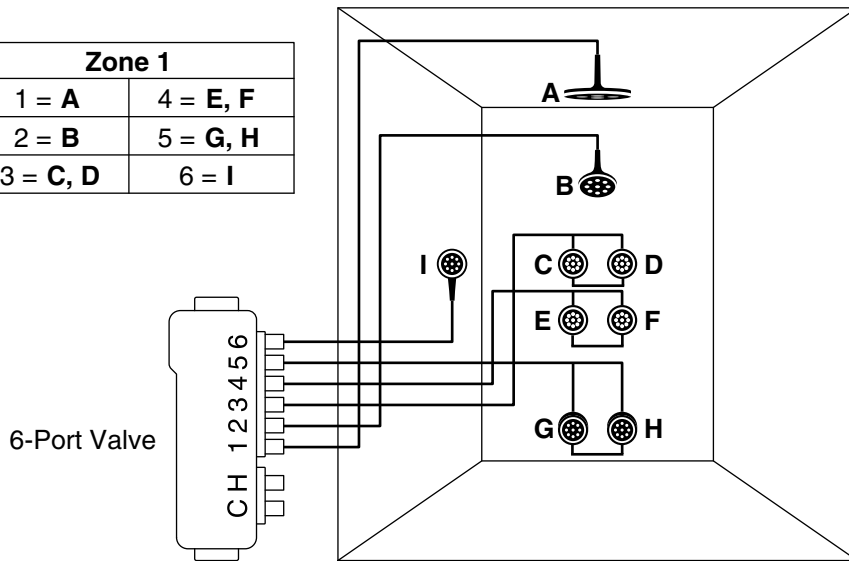

## Shower Configuration C – Plumbing Layout 1

**IMPORTANT!** For proper shower system setup and performance, especially regarding massage and spa function, refer to the "Shower Configurations – Overview" section for important information.

### Valves/Outlets Used

- Six-port valve = 6

### Flow Rates

**NOTE:** Water flow rates are calculated below based on six used outlet ports with equal flow rates. If your fittings have varying flow rates, calculate the total flow rate accordingly.

- Total, with 2.2 gal/min (8.3 l/min) per outlet = **13.2 gal/min (50 l/min)**
- Maximum total, with 2.5 gal/min (9.5 l/min) per outlet = **15 gal/min (56.8 l/min)**

### Spa Compatibility

- [warm up]
- [cool down]
- [focus]
- [restore]

### Steam Compatibility

- [steam coach]
- [detox]
- [repair]

**NOTE:** A pressure balance loop is required when two or more spays are connected to one outlet (C-D), (E-F) and (G-H).



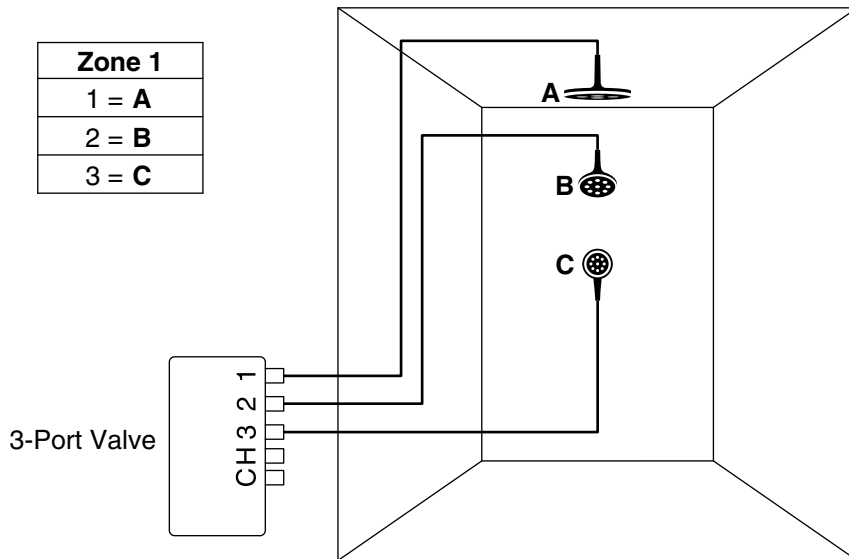

## Shower Configuration D – Plumbing Layout 1

**IMPORTANT!** For proper shower system setup and performance, especially regarding massage and spa function, refer to the "Shower Configurations – Overview" section for important information.

### Valves/Outlets Used

- Three-port valve = 3

### Flow Rates

**NOTE:** Water flow rates are calculated below based on three used outlet ports with equal flow rates. If your fittings have varying flow rates, calculate the total flow rate accordingly.

- Total, with 2.2 gal/min (8.3 l/min) per outlet = **6.6 gal/min (25 l/min)**
- Maximum total, with 2.5 gal/min (9.5 l/min) per outlet = **7.5 gal/min (28.4 l/min)**

### Spa Compatibility

- [focus]

### Steam Compatibility

- [steam coach]
- [detox]
- [repair]

Zone 1	
1 = A	4 = Open
2 = B	5 = Open
3 = C	6 = Open

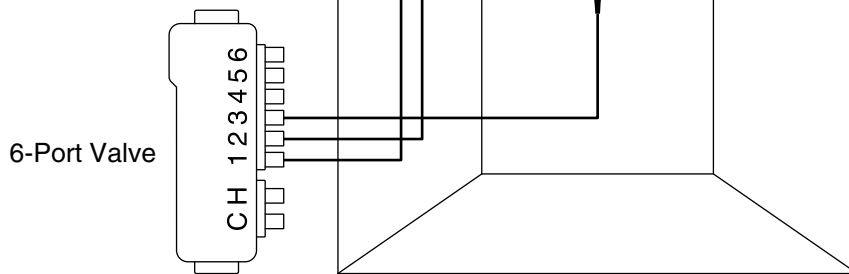

## Shower Configuration D – Plumbing Layout 2

**IMPORTANT!** For proper shower system setup and performance, especially regarding massage and spa function, refer to the "Shower Configurations – Overview" section for important information.

**NOTE:** Any valve outlets that are not used must be capped.

### Valves/Outlets Used

- Six-port valve = 3

### Flow Rates

**NOTE:** Water flow rates are calculated below based on three used outlet ports with equal flow rates. If additional valve outlets are being used, or your fittings have varying flow, calculate the total flow rate accordingly.

- Total, with 2.2 gal/min (8.3 l/min) per outlet = **13.2 gal/min (50 l/min)**
- Maximum total, with 2.5 gal/min (9.5 l/min) per outlet = **15 gal/min (56.8 l/min)**

### Spa Compatibility

- [focus]

### Steam Compatibility

- [steam coach]
- [detox]
- [repair]

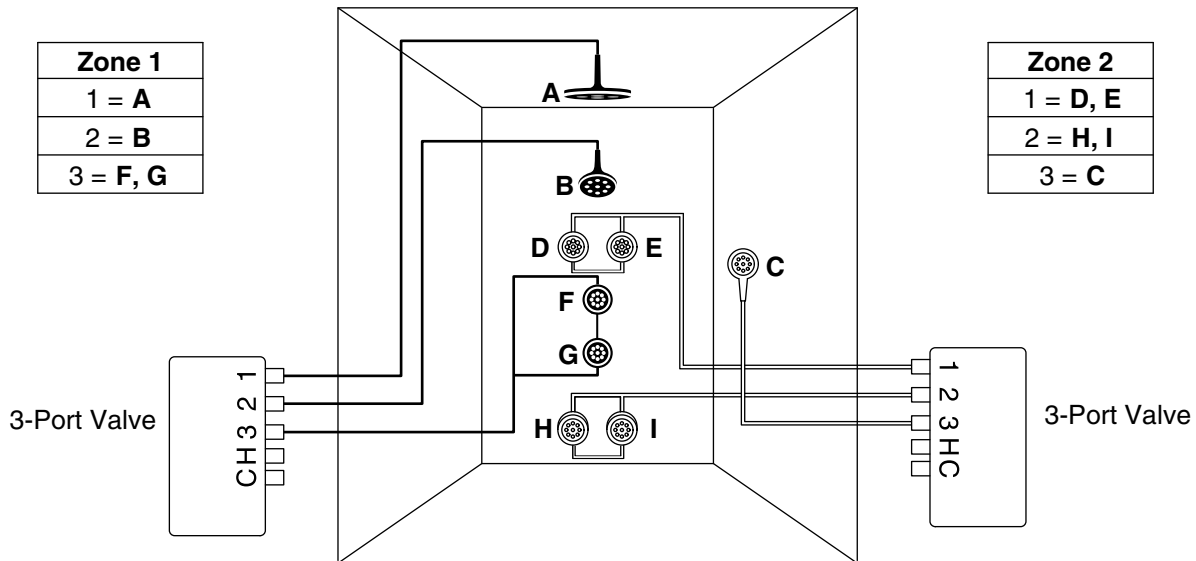

## Shower Configuration E – Plumbing Layout 1

**IMPORTANT!** For proper shower system setup and performance, especially regarding massage and spa function, refer to the "Shower Configurations – Overview" section for important information.

### Valves/Outlets Used

- Three-port valve (zone 1) = 3
- Three-port valve (zone 2) = 3

### Flow Rates

**NOTE:** This configuration is designed to deliver a maximum flow rate of 2.0 gal/min (7.6 l/min) at any time.

- For outlets with two connected bodysprays, each bodyspray must be rated with a maximum flow rate of 1.0 gal/min (3.8 l/min).

**NOTE:** This configuration activates one outlet at time during normal showering operation and spa experiences.

### Spa Compatibility

- [warm up]
- [cool down]
- [relax]
- [focus]
- [restore]
- [breathe]
- [flex]
- [headaid]

### Steam Compatibility

- [steam coach]
- [detox]
- [repair]

**NOTE:** A pressure balance loop is required when two or more spays are connected to one outlet (D-E) (F-G) and (H-I).

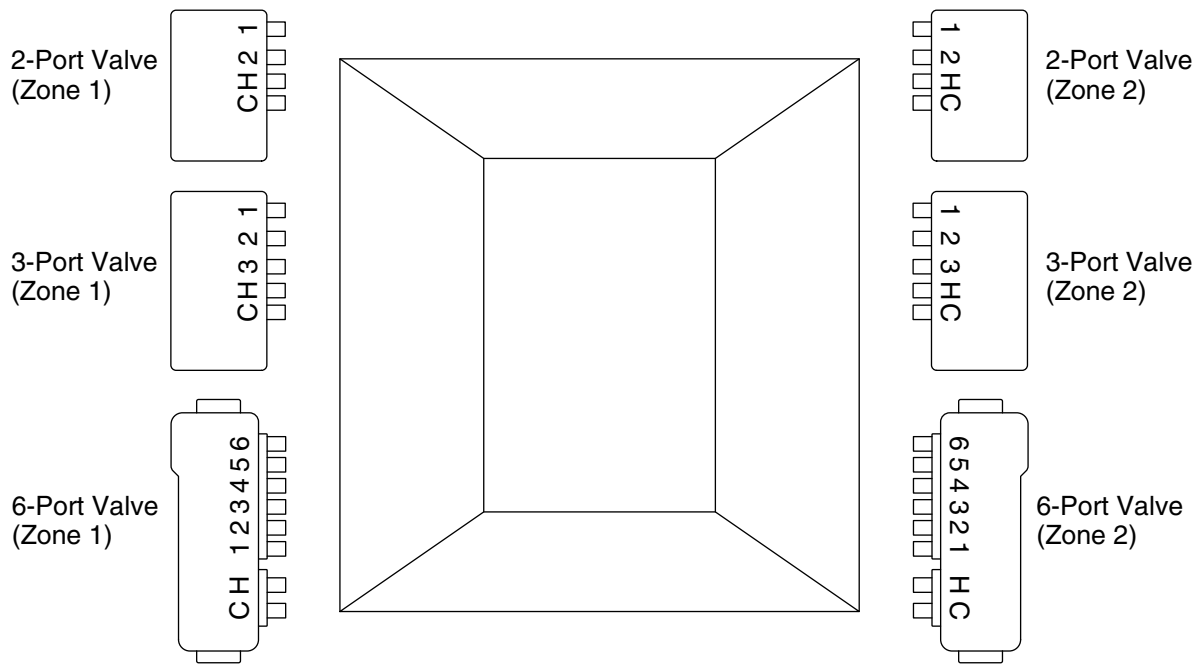

## Shower Configuration – Custom

**IMPORTANT!** For proper shower system setup and performance, especially regarding massage and spa function, refer to the "Shower Configurations – Overview" section for important information.

**NOTICE:** Custom shower configurations may not allow certain system features to be enabled.

**NOTE:** Configurations other than the preprogrammed options will limit preprogrammed spa and massage features.

**NOTE:** Any valve outlets that are not used must be capped.

### General Guidelines for Custom Configurations:

The primary showerhead should be plumbed to outlet 1. Custom mode will allow the user to select a different port as the primary, but it is not recommended.

When cycling during massage functions, bodysprays/watertiles will cycle from outlet 1 to outlet 6, regardless of which port is designated as the primary outlet.

The installer must determine the water outlet cycling order for the "Single" massage feature and plumb each water outlet accordingly.

Use the diagram above to draw in the components for your custom shower.

Draw lines from the valve to each component as your shower is plumbed.

### Massage Options

- Single
- Wave

## Web Pages

**Control** | **Settings** | **Service**

**System** | Users | Valve 1 | Valve 2 | Interface

**Available Shower Configurations**  
Configuration A

**Date/Time**  
5/14/2014 12:40 P -0600  
 Day Light Savings Time

**Date Format**  
 MM-DD-YYYY  
 DD-MM-YYYY  
 YYYY-MM-DD

**Time Format**  
 12 Hour  
 24 Hour

**Language** English | **Units**  Fahrenheit  Celsius

Settings Lock

## Interface

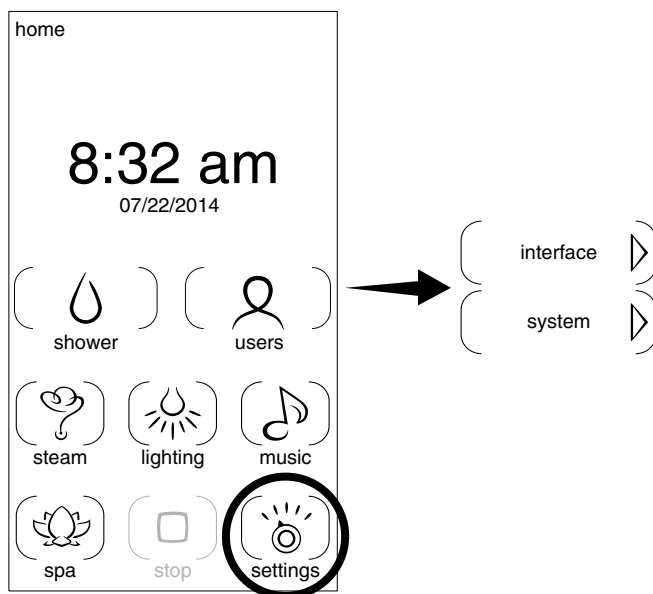

## Settings Overview

All system settings, such as valve setup, can be configured from the controller Web pages. Some settings can be configured from the interface.

For additional information on how to configure specific settings, refer to the appropriate sections in this guide.

### From the Web Pages

- On a computer or tablet connected to the same router as the controller, open a browser and enter the controller IP address. To obtain the IP address, refer to the "Initial System Setup" section.
- Click on the [Settings] tab.
- The [Settings] tab contains menus based on components connected to the system. All menu possibilities are: System, Users, Valve 1, Valve 2, Interface, Music, Lighting, Steam, and About.
- Click on a menu to configure various settings for that category.

### From the Interface

- From the [home] screen, touch the [settings] icon.
- The settings screen contains two menu options: interface and system.
- **Interface menu:** allows updates to individual interfaces.
- **System menu:** controls certain system settings. Some system settings can only be configured from the controller Web pages.

KOHLER<sup>®</sup>

Control
Settings
Service

System
Users
Valve 1
Valve 2
Interface
Music
Lighting
Steam
About

Available Shower Configurations

UI Settings Lock

Web Settings Lock

**Feature Enable**

Please read owner's manual regarding possible risks associated with these features

Massage

Steam

Spa

Lock Users

Date/Time

Daylight Saving Time

On

Off

Language

Units

Fahrenheit

Celsius

## Web Settings – System

### NOTICE TO INSTALLER:



**WARNING: Risk of personal injury.** Safety precautions must be followed when using shower features such as [Massage] and [Spa]. Before enabling, ensure that the homeowner has read the associated risks listed in the guides for these features.

### Preprogrammed Shower Configurations

**NOTE:** Preprogrammed shower configurations are outlined in the “Configurations” sections.

- If components are installed for preprogrammed shower configurations, the components can be automatically populated on the Web pages.
- Shower configurations are available based on the number of valves connected to the controller.
- To populate preprogrammed configurations, select the appropriate dropdown option in the [Available Shower Configurations] field. The shower components will appear in the outlet options on the valve menus.
- If equipped, shower features, such as [Massage] and [Spa] must be enabled in order to function. **Safety instructions for each feature must be read by the homeowner before it is enabled. Refer to the guide for each feature.**

### Custom Shower Configurations

**NOTE:** Spa features and certain massage features will not be available on custom configurations.

- For custom system configurations, select the “Custom” dropdown option in the [Available Shower Configurations] field.

## Web Settings – System (cont.)

- To check or configure custom valve settings, go to the [Valve 1] or [Valve 2] menus. Refer to the “Web Settings – Valve” section.

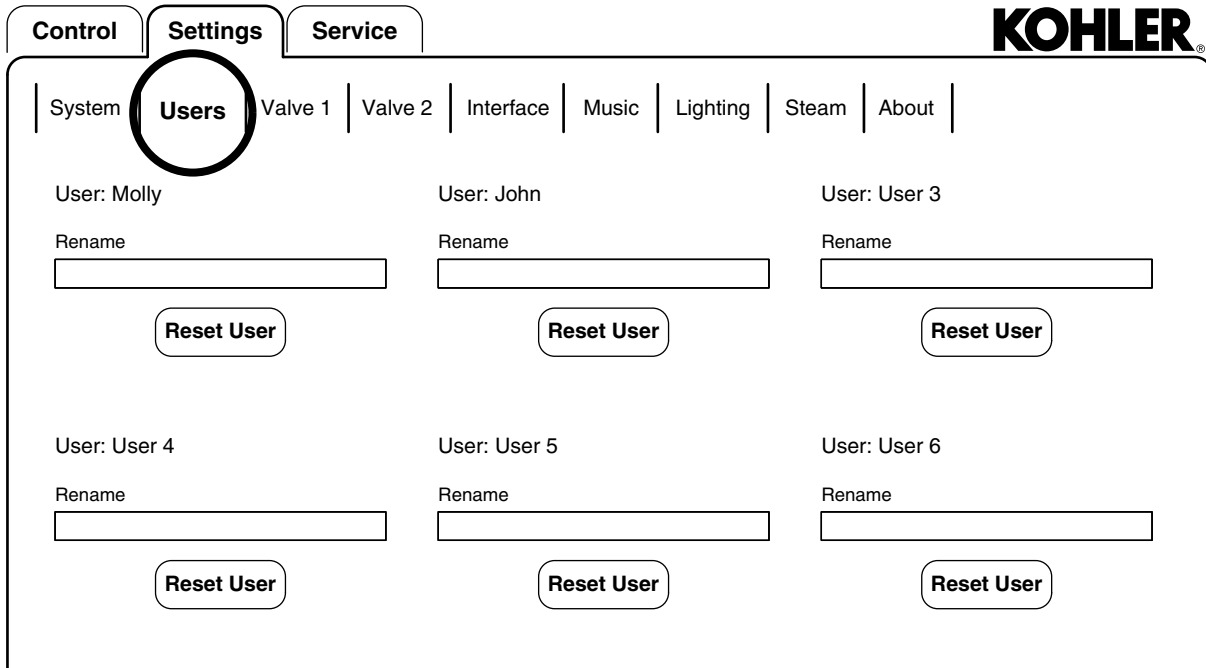

## Web Settings – Users

**Web page path:** Settings > Users

**Function:** assign user names to identify user presets on the interface(s).

**NOTE:** User names can only be entered through the controller Web page. The names will appear on the interface, but name updates are not available through the interface.

- Enter each user name in the available fields. Name length is limited to 12 characters.
- The names will appear on the interface in the same order as they appear on the Web page.
- To clear a user and their saved presets from the system, click the “Reset User” button for that specified user.
- For configuring and saving user presets, refer to the “Users – Setting Preferences” section.



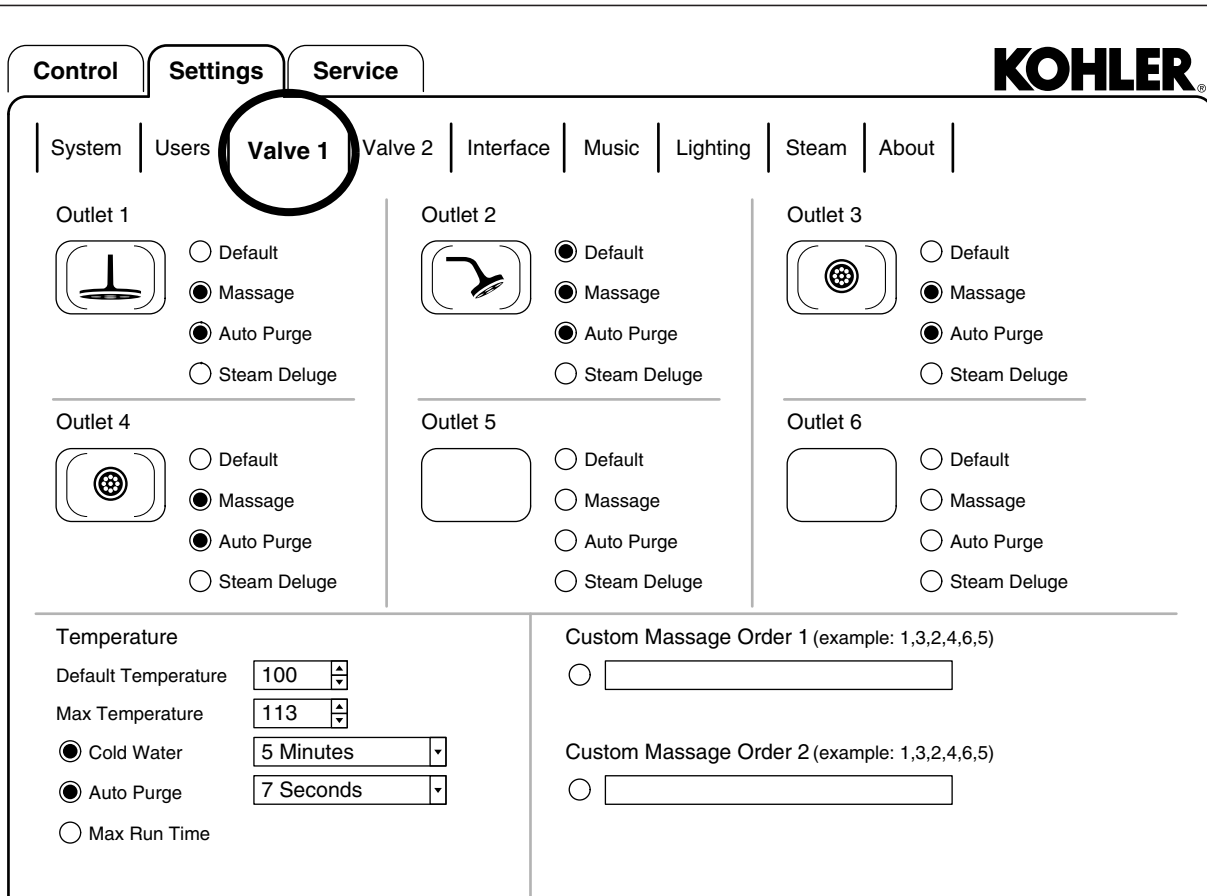

## Web Settings – Valve

**Web page path:** Settings > Valve 1 (or Valve 2)

**IMPORTANT!** To ease setup for a multiple valve system, valve 1 (zone 1) should be connected to the system controller before valve 2 (zone 2). If valve 1 does not appear on the controller Web page before connecting the second valve to the controller, swap the valves by clicking the “Swap Valves 1 and 2” button.

### Valve Configuration – Custom Options

- For preprogrammed configurations, refer to the “Configurations” sections.
- **Function:** sets the outlet icons of your custom configuration to match your shower installation.

**IMPORTANT!** The fitting shown in the outlet window on the Web page should be the fitting that is physically plumbed to that valve outlet.

- Click the icon window to scroll through the list of available water outlet options for your shower configuration (see “Water Outlet Options” section).

### Select Default Outlet

- **Function:** sets the water outlet that will turn on if the user makes no shower selections before touching the [start] icon on the interface.
- Determine the primary outlet by clicking the radio button next to “Default.” Only one default outlet can be selected per system.

### Add/Remove Outlets from Massage Cycling Pattern

- **Function:** sets the water outlets that will cycle when the massage feature is activated.

## Web Settings – Valve (cont.)

- Add or remove outlets by clicking the radio button next to "Massage."

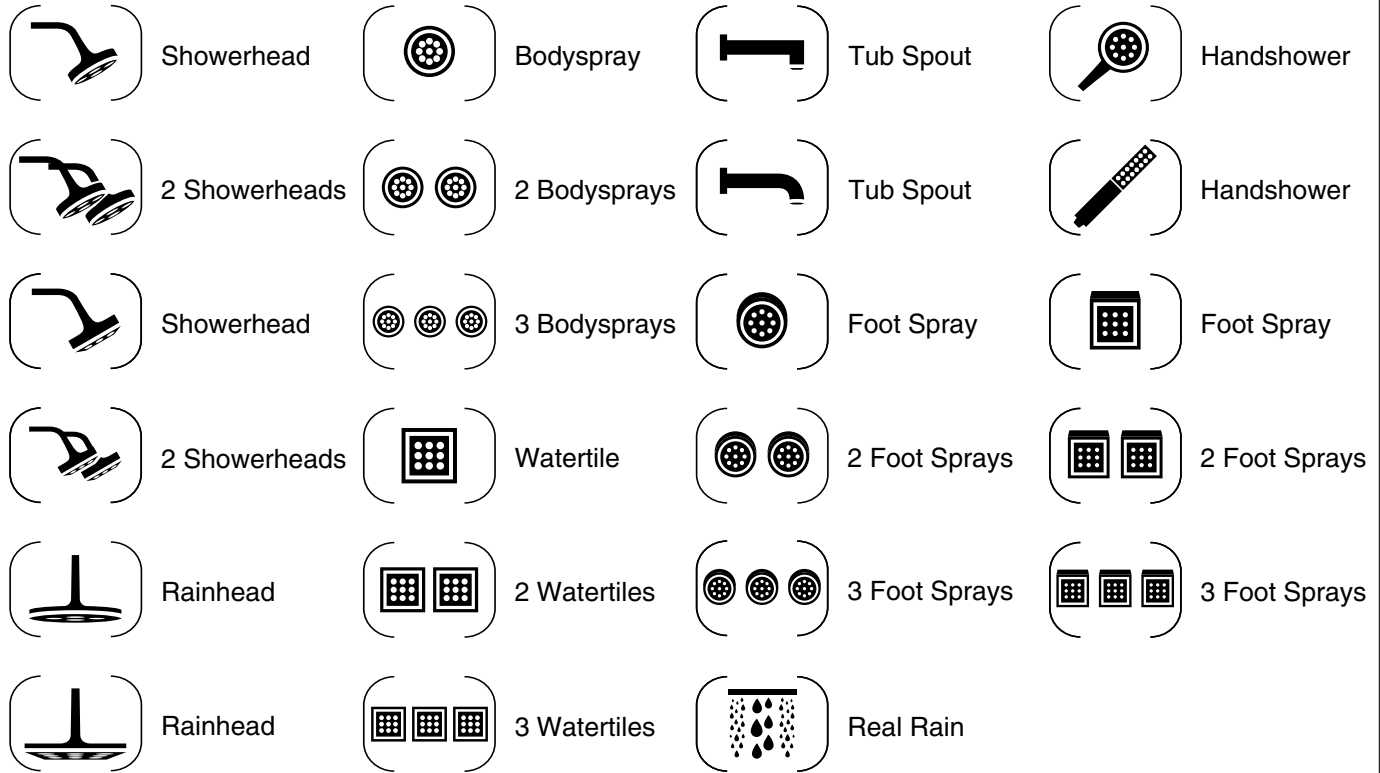

## Web Settings – Water Outlet Options

**Web page path:** Settings > Valve 1 (or Valve 2)

Only certain water outlet options will be available, depending on your system configuration.

The above illustration shows the range of water outlet fittings that can be plumbed to the valve.

KOHLER®

Control
Settings
Service

System
Users
Valve 1
Valve 2
Interface
Music
Lighting
Steam
About

**Outlet 1**

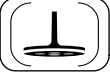

Default

Message

Auto Purge

Steam Deluge

**Outlet 2**



Default

Message

Auto Purge

Steam Deluge

**Outlet 3**

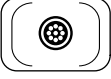

Default

Message

Auto Purge

Steam Deluge

**Outlet 4**



Default

Message

Auto Purge

Steam Deluge

**Outlet 5**

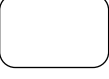

Default

Message

Auto Purge

Steam Deluge

**Outlet 6**

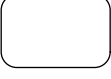

Default

Message

Auto Purge

Steam Deluge

**Temperature**

Default Temperature

Max Temperature

Cold Water

Auto Purge

Max Run Time

Custom Message Order 1 (example: 1,3,2,4,6,5)

Custom Message Order 2 (example: 1,3,2,4,6,5)

## Web Settings – Default and Maximum Temperature

**Web page path:** Settings > Valve 1 (or Valve 2)

**Function:** set the default and maximum water temperature for each valve.

### Default Temperature

- In the [Default Temperature] box, enter the desired default temperature.
- The factory default is 100°F (38°C).
- To change the temperature unit display to Fahrenheit or Celsius, go to the [System] menu.

### Maximum Temperature

- In the [Max Temperature] box, enter the desired maximum temperature limit up to 120°F (49°C).
- The factory default is 113°F (45°C).
- To change the temperature unit display to Fahrenheit or Celsius, go to the [System] menu.

KOHLER®

Control
Settings
Service

System
Users
**Valve 1**
Valve 2
Interface
Music
Lighting
Steam
About

**Outlet 1**

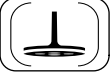

Default

**Message**

**Auto Purge**

Steam Deluge

**Outlet 2**



**Default**

**Message**

**Auto Purge**

Steam Deluge

**Outlet 3**

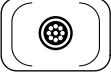

Default

**Message**

**Auto Purge**

Steam Deluge

**Outlet 4**



Default

**Message**

**Auto Purge**

Steam Deluge

**Outlet 5**

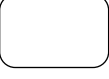

Default

Message

Auto Purge

Steam Deluge

**Outlet 6**

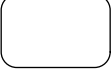

Default

Message

Auto Purge

Steam Deluge

**Temperature**

Default Temperature

Max Temperature

**Cold Water**

**Auto Purge**

Max Run Time

**Custom Message Order 1** (example: 1,3,2,4,6,5)

**Custom Message Order 2** (example: 1,3,2,4,6,5)

## Web Settings – Cold Water

**Web page path:** Settings > Valve 1 (or Valve 2)

The cold water feature default is "5 Minutes."

When enabled, this feature shuts the water off when the valve cannot maintain its target temperature during the specified time period. This typically occurs when the hot water supply has been depleted. The timer starts when the target temperature is not achieved within 1°. If this feature is not enabled, the water will continue to run until the shower is turned off by the user.

- Click the radio button next to [Cold Water] to activate the feature.
- Select the desired cold water time duration in the dropdown box next to [Cold Water].
- Time duration options are 2 minutes, 5 minutes, 7 minutes, or 10 minutes.
- To deactivate cold water, click the radio button a second time to "uncheck" it.

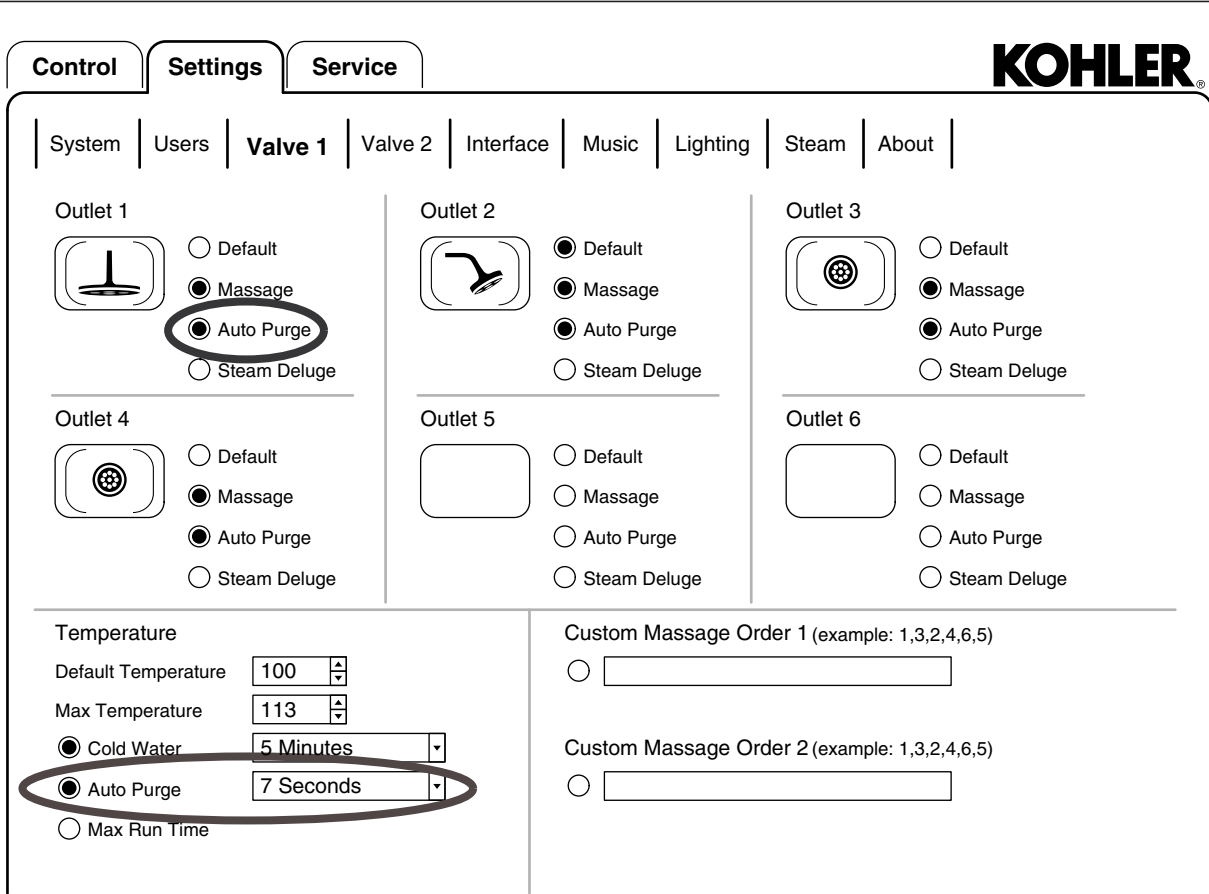

## Web Settings – Auto Purge

**Web page path:** Settings > Valve 1 (or Valve 2)

The auto-purge feature default is "7 Seconds."

This feature turns on all water outlets to purge the cold water from the shower lines and reach the set temperature faster. Once the auto-purge has run for the set amount of time, the user preset will determine which outlets remain on.

The auto-purge feature will only activate if the shower has been inactive for 30 minutes or longer.

- Click the radio button next to [auto-purge] to activate the feature.
- Select the desired auto-purge time duration in the dropdown box next to [auto-purge].
- Time duration options are 0, 7, 15, 30, 45, or 60 seconds.
- To deactivate auto-purge, click the radio button a second time to "uncheck" it.

KOHLER®

Control
Settings
Service

System
Users
Valve 1
Valve 2
Interface
Music
Lighting
Steam
About

**Outlet 1**

Default  
 **Message**  
 Auto Purge  
 Steam Deluge

---

**Outlet 4**

Default  
 **Message**  
 Auto Purge  
 Steam Deluge

**Outlet 2**

**Default**  
 Message  
 Auto Purge  
 Steam Deluge

---

**Outlet 5**

Default  
 Message  
 Auto Purge  
 Steam Deluge

**Outlet 3**

Default  
 **Message**  
 Auto Purge  
 Steam Deluge

---

**Outlet 6**

Default  
 Message  
 Auto Purge  
 Steam Deluge

**Temperature**

Default Temperature

Max Temperature

Cold Water

Auto Purge

Max Run Time

**Custom Message Order 1** (example: 1,3,2,4,6,5)

**Custom Message Order 2** (example: 1,3,2,4,6,5)

## Web Settings – Massage

Web page path: Settings > Valve 1 (or Valve 2)

**IMPORTANT!** Please read the following information regarding the possible risks associated with **massage**. Consult your physician before any hydrotherapy treatment, especially if you are pregnant, have cancer or heart disease. As with many types of therapies and massages, hydromassage can be unsafe if a person has certain types of illnesses. Consult a physician to determine whether hydromassage is suitable for your case when a condition is persistent or recurrent. Elderly people and young children may be prone to exhaustion by too much heat and should avoid long full body heat treatments.

### Activate Massage

**NOTE:** The massage feature default is "OFF." For this feature to be available for use while showering, it must be first activated in the [System] menu.

**NOTE:** You may experience temperature variations during massage mode dependent on your particular installation.

- For each outlet, click the radio button next to [Message] to activate the feature for that outlet.
- To deactivate the massage feature for any outlet, click the radio button a second time to "uncheck" it.

### Custom Massage

- Two custom massage features can be created using the [Message Order] boxes.
- In each box, enter the desired order of the outlets that will cycle message pulses. The outlet number corresponds to the outlet designation shown in the upper part of the [Valve 1] or [Valve 2] Web pages.

### **Web Settings – Massage (cont.)**

- Enter the outlets according to number, separated by commas (example: 1,3,2,4).
- Any sequence of numbers that is not separated by a comma will cycle those outlets at the same time (example: 1,23,4,6,5 – outlets 2 and 3 will cycle massage pulses at the same time).
- Once activated/deactivated, press the [Back Icon] until you return to the settings menu.



Interface Outlet Display Order (Click and drag to rearrange within zone)

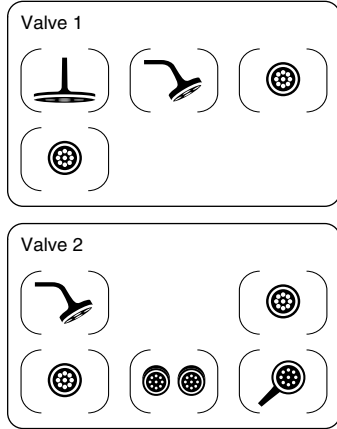

## Web Settings – Interface

**Web page path:** Settings > Interface

**Function:** allows changes to the order the water outlets are displayed on the interface(s).

**NOTE:** To see the [Interface] menu on the controller Web pages, a K-99693 digital interface must be installed and connected to the system controller.

**NOTE:** By default, the water outlets are cycled in the order displayed. Changing the display order will not change the cycling order.

- Click on the outlet icon to scroll through the available options.
- Available options are determined by the shower fittings that are plumbed to the valve(s) for your system configuration.

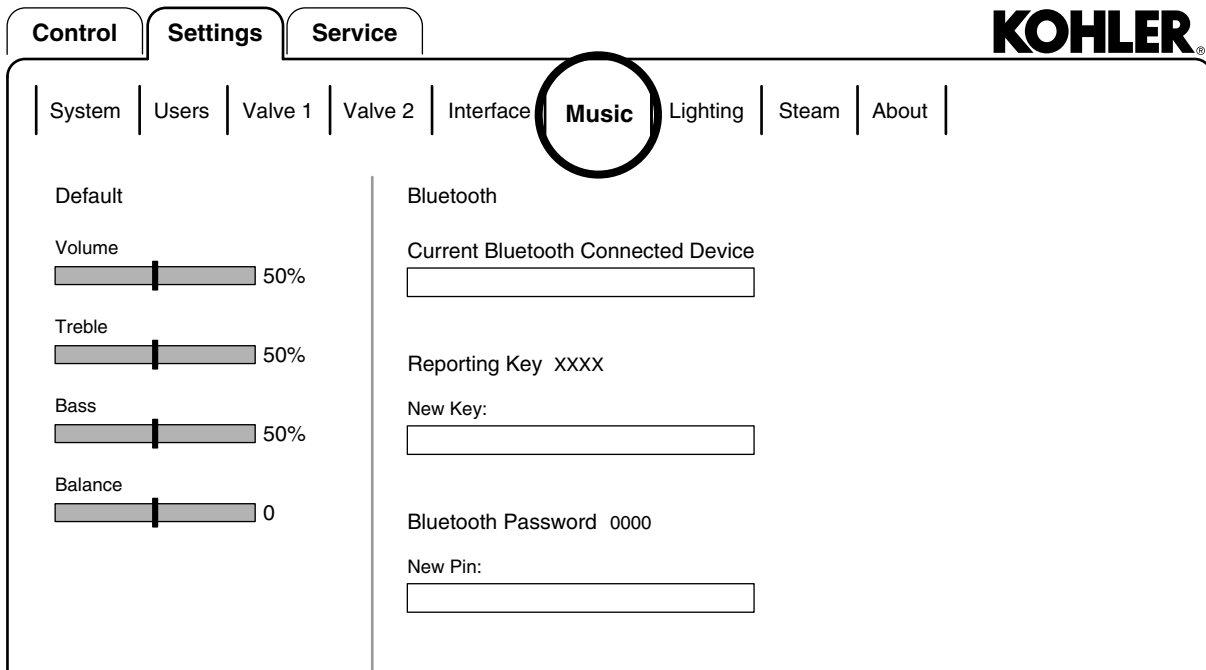

## Web Settings – Music

**Web page path:** Settings > Music

**Function:** allows adjustment of default audio settings and changes to the Bluetooth pairing settings.

**NOTE:** To see the [Music] menu on the controller Web pages, the K-99696 amplifier must be installed and connected to the system controller. To hear audio signals through the amplifier, speakers must be properly connected to the amplifier. Refer to the amplifier Installation and Care Guide.

- To adjust the default settings for audio output, click and drag the vertical rod along the horizontal bar for each of the four settings.
- If a Bluetooth device is currently paired to the system, the device ID will be displayed in the "Current Bluetooth Connected Device" field.

**NOTE:** The "Current Bluetooth Connected Device" field cannot be edited. It is for information purposes only.

- To change Bluetooth pairing settings, enter the new reporting key and/or password.

KOHLER®

Control
Settings
Service

System
Users
Valve 1
Valve 2
Interface
Music
Lighting
Steam
About

ID New Load Module

Remove Load Module

Light 1  
 Light 2

---

**Light 1**

Name Overhead

Rename

Load Type Switch/Toggle

Delay by

**Light 2**

Name

Rename

Load Type Dimmable

Light Fade Speed

Default Brightness

Delay by

**Pairing Button**

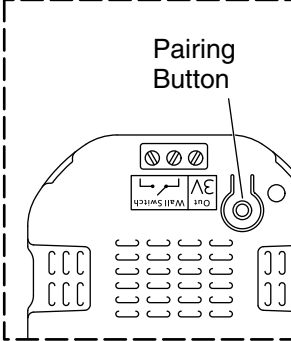

## Web Settings – Room Lighting



**CAUTION: Risk of electric shock.** Avoid touching any electrical wires connected to the load module during the pairing procedure.

**Web page path:** Settings > Lighting

**Function:** identifies (pairs) installed load modules, and allows adjustments to default settings for lighting connected to the load modules.

**NOTE:** To see the [lighting] menu on the controller Web pages, the K-99701 lighting bridge must be installed and connected to the system controller.

**NOTE:** Up to three load modules (K-99699 on/off module and/or K-99700 dimmer module) can be installed to toggle electrical switches for standard or dimmable lighting, exhaust fans, heated towel bars, or other electrical items controlled by a toggle switch.

### Identify (Pair) a Load Module

**IMPORTANT!** To perform the identification procedure, the load module(s) must be properly wired to the electrical switch, and the pairing button on the module(s) must be accessible.

□ To initiate identification of a load module, click the "ID New Load Module" button.

**NOTE:** The pairing button on the load module must be pressed within 60 seconds of clicking the "ID New Load Module" button.

- Press the pairing button on the load module. The LED light will blink, and the light will momentarily turn on.
- Once the LED stops blinking and the light turns off, the load module will appear on the Web page.
- The load module type will automatically be designated as either "Switch/Toggle" or "Dimmable" according to the paired module type.
- Repeat the procedure to identify (pair) additional modules.
- Once three modules have been paired, the "ID New Load Module" button will disappear from the Web page.

## Web Settings – Room Lighting (cont.)

### Remove a Load Module

**IMPORTANT!** To perform the removal procedure, the load module must be selected in the menu before clicking the "Remove Load Module" button.

- To disconnect a load module from the lighting bridge, select the module in the menu next to the "Remove Load Module" button.
- Once a module is selected, click the "Remove Load Module" button.
- A pop-up window will appear, stating removal is in progress.
- When removal is complete, the selected load module will disappear from the Web page.

### Adjust Settings

**NOTE:** Lighting names must be entered through the controller Web page to appear on the interface.

- To rename a load module, enter the desired name in the "Rename" field, then hit "Enter" on the keyboard or click outside the "Rename" field.
- For dimmable lighting, to change the default light fade speed, choose the desired option in the dropdown box under [Light Fade Speed].
- For dimmable lighting, to adjust the default brightness, click and drag the vertical rod along the horizontal brightness bar.

### Adjust Delay Time

- Lighting that is connected to the DTV+ system will be turned off when the user presses the power button on the interface. Lighting can be delayed for certain period of time after the system is turned off. The delay time is designated on the controller Web Pages.

**NOTE:** Delay time is linked between load modules. Changing the time for one module will update all modules to the same time.

- To delay the time when a light turns off after the system is turned off, click the radio button next to [Delay by].
- To adjust the delay time interval when the light(s) turn off, choose the desired option in the dropdown box next to [Delay by].

KOHLER®

Control
Settings
Service

System
Users
Valve 1
Valve 2
Interface
Music
Lighting
Steam
About

ID New Load Module

Remove Load Module

Light 1	▼
Light 2	▼

---

**Light 1**

Name: Light 1

Rename:

Load Type: Dimmable

Light Fade Speed

▼

Default Brightness

Delay Off for  ▼

**Light 2**

Name: Light 2

Rename:

Load Type: Dimmable

Light Fade Speed

▼

Default Brightness

Delay Off for  ▼

**Light 3**

Name: Light 3

Rename:

Load Type: Switch

Light Fade Speed

Default Brightness

Delay Off for  ▼

---

WaterTile Ambient Rain

Light Fade Speed

▼

Default Brightness

Default White

▼

Effects Speed

▼

## Web Settings – Rain Panel Lighting

**Web page path:** Settings > Lighting > WaterTile® Ambient Rain

**Function:** allows adjustments to default lighting and effects features for the ambient rain panel.

**NOTE:** To see the [Lighting] menu on the controller Web pages, the K-98741 ambient rain panel must be installed and connected to the system controller.

- To change the default light fade speed, click the dropdown arrow to the right of the field.
- To change the default light color, click the dropdown arrow to the right of the field.
- To adjust the default light brightness, click and drag the vertical rod along the horizontal brightness bar.
- To change the default speed at which the effects move along the panel, click the dropdown arrow to the right of the field.

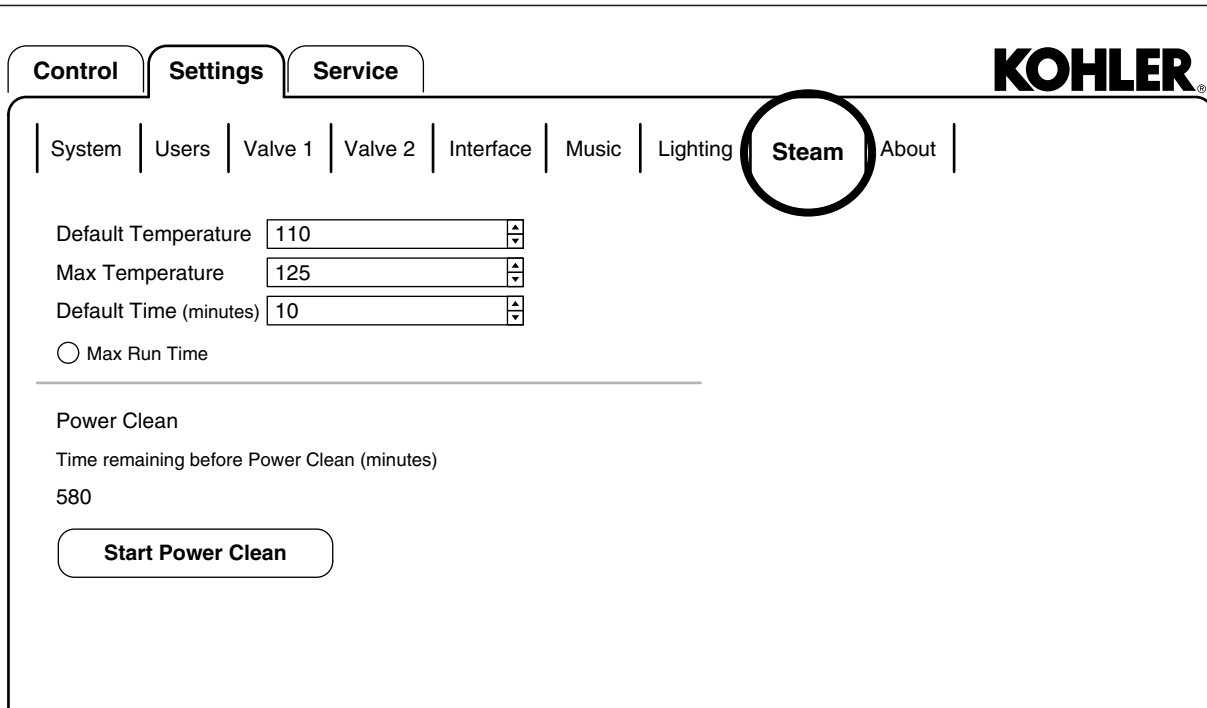

## Web Settings – Steam

**Web page path:** Settings > Steam

**Function:** allows adjustments to default steam temperatures and duration, and indicates the number of minutes left before “Power Clean” must be activated.

**NOTE:** To see the [Steam] menu on the controller Web pages, a KOHLER steam generator must be installed and connected to the system controller, and the feature must be enabled on the [System] Web page.

**NOTICE:** The steam system is set to allow for 600 minutes of usage before a cleaning cycle is required. After 600 minutes, the cleaning cycle must be completed in order to activate steam use and reset the 600-minute counter.

**NOTICE:** Power clean will run for 45 minutes. Once activated, you must remain out of the steam area until the cleaning cycle has completed.

- To adjust the default and maximum temperature settings, click the up or down arrows to the right of the temperature field.
- To adjust the default steam duration, click the up or down arrows to the right of the time field.
- To initiate a power clean cycle, click [Start Power Clean].

**CAUTION:** Stay out of the steam area until the cleaning cycle is complete.

System

Users

Valve 1

Valve 2

Interface

Music

Lighting

Steam

 About

## Network

**Controller IP address**

0.0.0.0

**Gateway**

0.0.0.0

**MAC Address**

00:14:6F:0E:10:D5

## Software Version

**Interface 1**

OS: v0.0.0.0

Graphics: v0.0.0.0

Language: v0.0.0.0

TouchPanel: v0.0.0

**Interface 2**

OS: v0.0.0.0

Graphics: v0.0.0.0

Language: v0.0.0.0

TouchPanel: v0.0.0

**Interface 3**

OS: v0.0.0.0

Graphics: v0.0.0.0

Language: v0.0.0.0

TouchPanel: v0.0.0

**Valve 1**

v0.0

**Valve 2**

v0.0

**Controller**

v0.0.0.0

**Steam**

v0.0

**Amplifier**

v1.0

**WaterTileRain**

v0.0

## Web Settings – About

**Web page path:** Settings > About

**Function:** displays software versions for connected system components.

- The displayed software information is what is current since the last download.
- To receive the latest updates for any connected system components, refer to the “Web Service – Updates” section.

**Diagnostics**

Updates

## Connection Diagnostics

**Interface 1**  
Connected

**Interface 2**  
Connected

**Valve 1**  
Connected

**Valve 2**  
Connected

**Controller**  
Connected

**Steam**  
Connected

**Amplifier**  
Connected

**WaterTileRain**  
Connected

## Reset

## Six Port Valve Service

Valve 1 Calibration Code

Valve 2 Calibration Code

## Error Log

```

Number Source H:M:S D/M/Y
UI Error: 100 07:22:27 a.m. 05/14/2014
Controller Error: 104 04:28:26 p.m. 05/13/2014

```

## Web Service – Diagnostics

**Web page path:** Service > Diagnostics

**Function:** displays information on connected system components, error log information, and provides reset options.

### Reset Options

- **Reset to Saved Default:** resets the system back to the latest saved default on the [System] Web page. Refer to the "Web Settings – System" section.



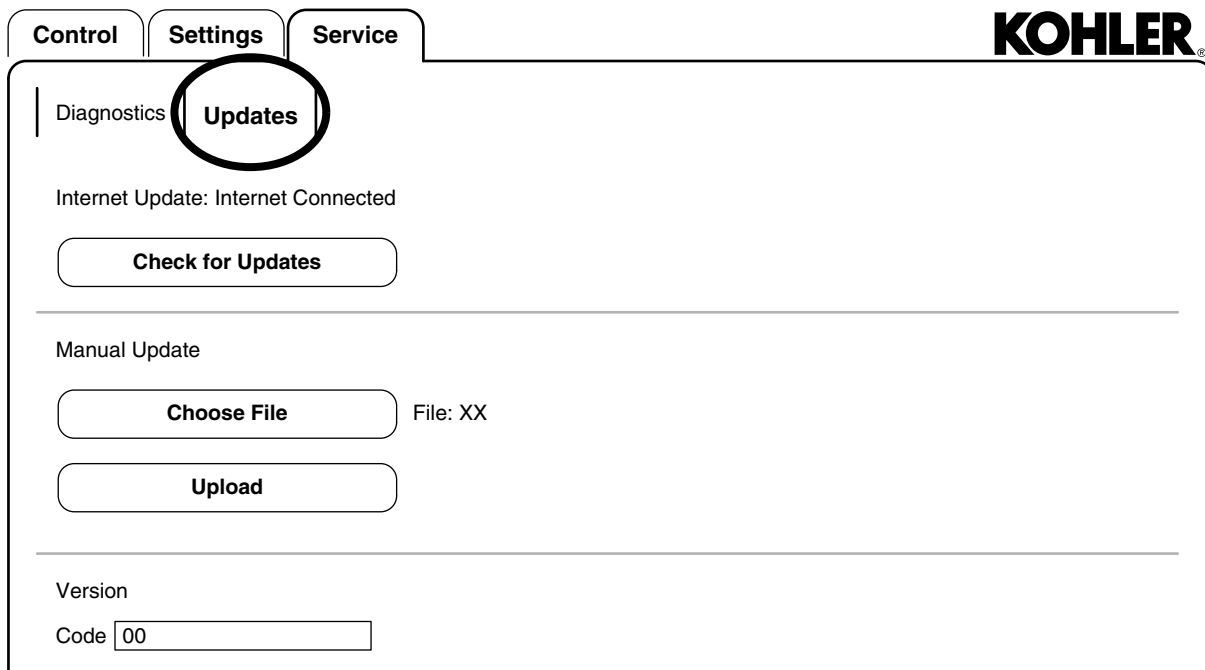

## Web Service – Updates

**Web page path:** Service > Updates

**Function:** enables download of available system software updates.

**NOTE:** The controller will check for software updates daily (around midnight), and will automatically download the software. Software can also be updated manually.

**NOTE:** Internet access is required for downloading the latest software for system components.

- Make sure the computer or tablet from which the controller Web pages are being accessed is connected to the internet.
- Click on the [Service] tab, then on [Updates].
- Click [Check for Updates] to download the latest software for any connected system components.
- If updates are available, the controller will automatically download the software.
- To manually download updates from a file, click [Choose File], then browse for and select the file.
- Once the file is selected, click [Upload].

**NOTE:** Software installation must be completed from the interface. Refer to the "System Settings – Update" section.

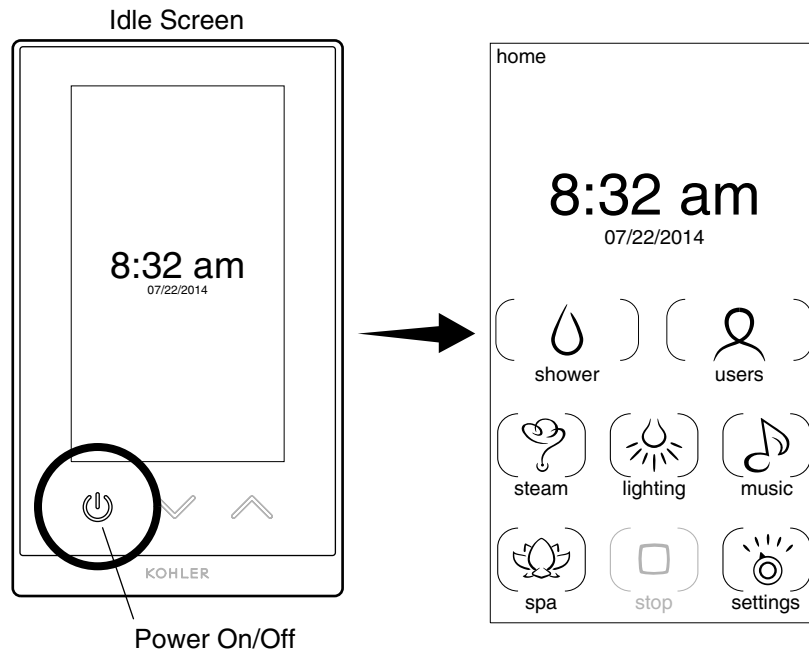

## Interface – Power System On/Off

The system allows the option to turn off the entire system, or turn off individual features while leaving others on. To turn off individual features, refer to the "Interface – Turn Features Off" section.

**NOTE:** After 20 minutes of inactivity from user interaction, the interface will turn idle and the power icon will be illuminated. If the power icon is not lit, verify that the interface and power cables are plugged into the controller and the power supply is plugged into the electrical outlet.

**NOTE:** Firm pressure may need to be applied when pressing the power icon and navigating the touchscreen. The interface is designed for water resistance. Screen sensitivity may be less than experienced on other touchscreen devices.

### Power On

- Press the [Power Icon] or touch any part of the interface screen to turn the interface on.
- The interface will illuminate and the home screen will appear.

### Power Off

- To turn the entire system off at once, press the [Power Icon].
- All active features will stop and the interface will display the idle screen.
- When the entire system is powered off, all features return to default settings.
- Any features that were functioning when the system was turned off cannot be resumed.

### Within a Feature

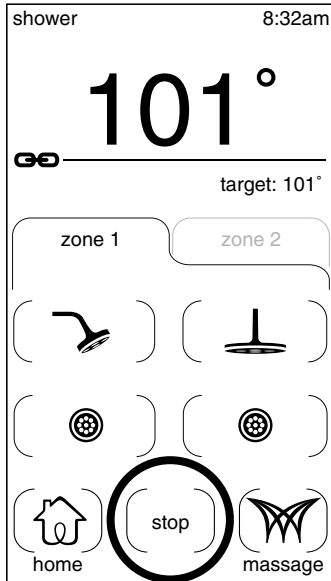

### From Home or Settings (Ask Off)

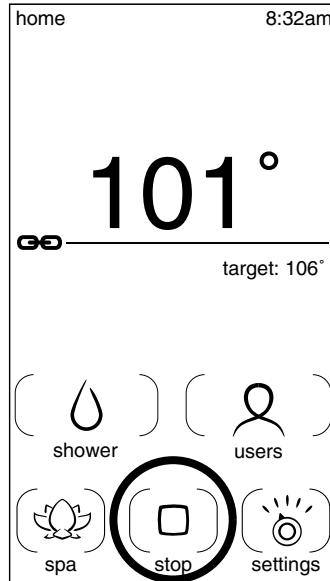

## Interface – Turn Features Off

The system allows the option to turn off the entire system, or turn off individual features while leaving others on. To turn off the entire system, refer to the "Interface – Power System On/Off" section.

**NOTE:** If no features are active, the [stop] icon will not be illuminated and will not be accessible.

### Turn Off – Within a Feature

**NOTE:** Within a feature screen, if that feature is not currently on, the [stop] icon will not appear. Instead, a green [start] icon will be displayed until the feature is activated. Each system feature (except music) will display a [stop] icon while the feature is on.

- To turn off an active feature from within that feature screen, touch the red [stop] icon.
- A pop-up window will appear showing all features that are currently on.
- Touch the radio button next to the feature(s) that you want to stop.
- Press [ok] to confirm. All selected items will turn off.

### Turn Off – From Home or Settings (Ask Off)

**NOTE:** If no features are running, the [stop] icon will not be illuminated and will not be accessible.

- To selectively turn off active features, touch the red square [stop] icon.
- A pop-up window will appear showing all features that are currently on.
- Touch the features you want to stop. The selected features and associated radio buttons will be highlighted.
- Press [ok] to confirm. All selected items will turn off.

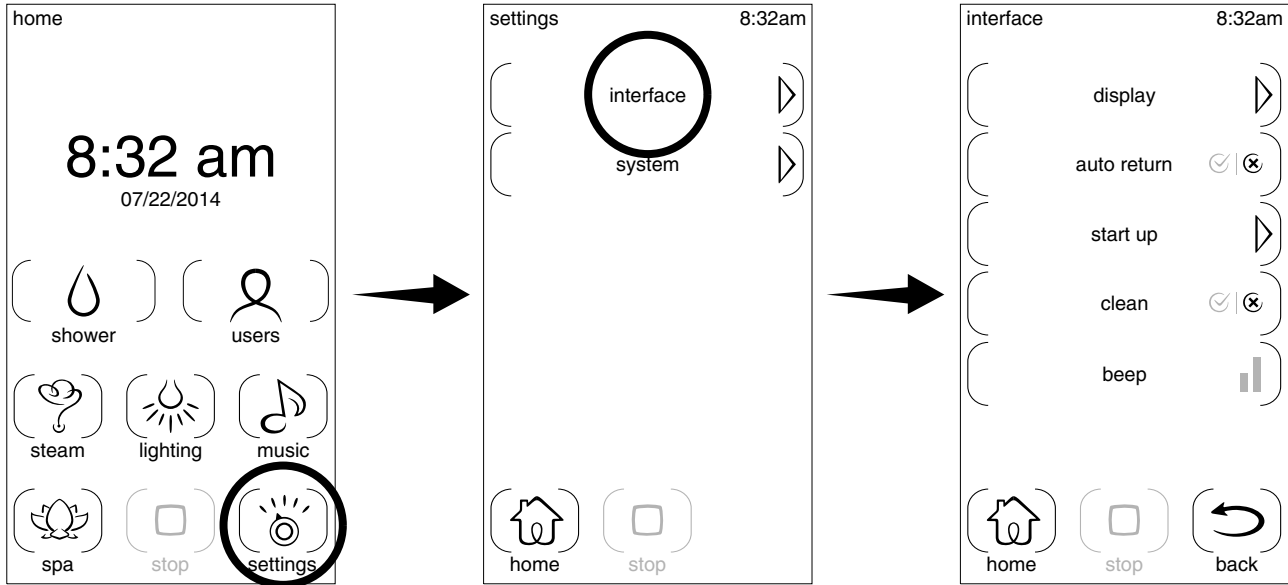

## Interface Settings – Overview

**Path:** settings > interface

**Function:** allows customization of interface settings. The customization is specific to the individual interface. If a system has multiple interfaces, modifications to one interface will not appear automatically on the other interface. For example, the interface inside the shower can be set to a higher or lower brightness than the interface outside the shower.

**NOTE:** The settings menu is not accessible when water is running or steam is on. A “not available” pop-up window will appear if the user touches the [settings] icon while any shower or steam feature is activated.

The interface settings menu consists of five categories:

- **Display** – adjusts screen brightness and dim settings.
- **Auto Return** – returns the interface to the highest active feature screen after 30 seconds of inactivity.
- **Start Up** – sets the screen that appears at start up.
- **Clean** – locks the interface for 30 seconds so the screen can be cleaned.
- **Beep** – adjusts the volume of the interface beeps.

- From the home screen, touch the [settings] icon.
- Touch the [interface] option.
- Select a category to view/adjust interface options as desired.

**NOTE:** The [back] icon appears on all settings screens. Touch the [back] icon to return to the previous screen.

- Touch the [home] or [back] icon to exit the interface settings menu.

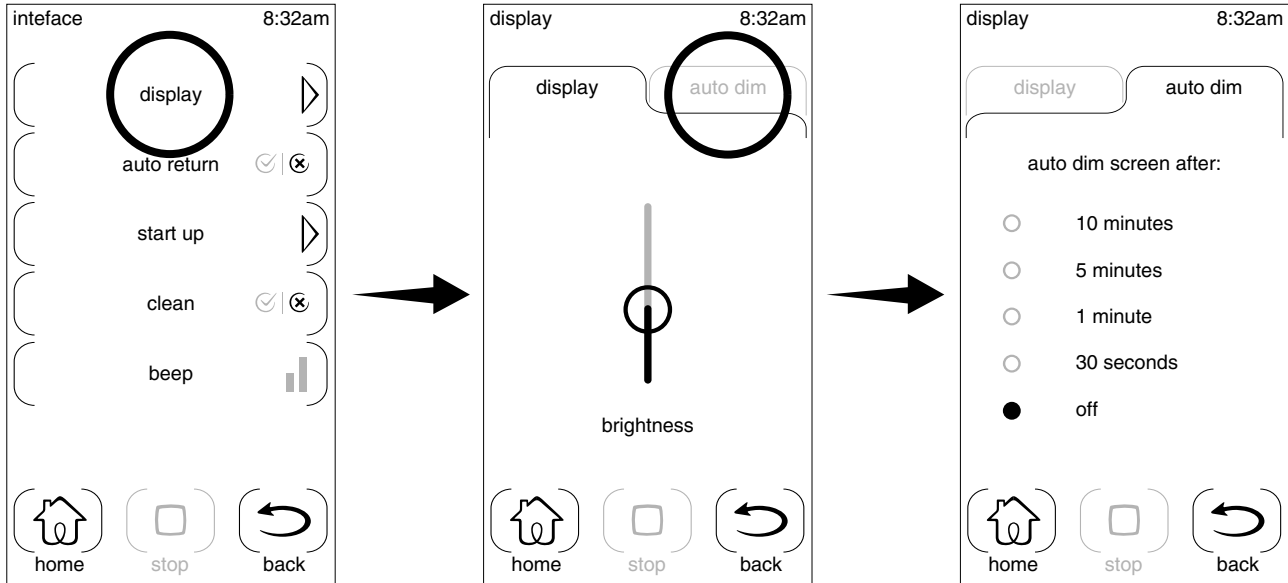

## Interface Settings – Display

**Path:** settings > interface > display

**Function:** adjusts the screen brightness.

**Factory default:** medium brightness (50%)

- From the home screen, touch the [settings] icon.
- Touch the [interface] option, then touch [display].
- Touch the circle to slide it along the bar. Slide up to increase brightness; slide down to decrease brightness.

### Auto Dim

**Path:** settings > interface > display > auto dim

**Function:** dims the screen to 50% of the current brightness after the specified period of inactivity.

**Factory default:** off

- From the home screen, touch the [settings] icon.
- Touch the [interface] option, then touch [display].
- Touch the [auto dim] tab.
- Select the desired inactivity time frame after which the screen will dim.
- Touch the [home] or [back] icon to exit the display menu.

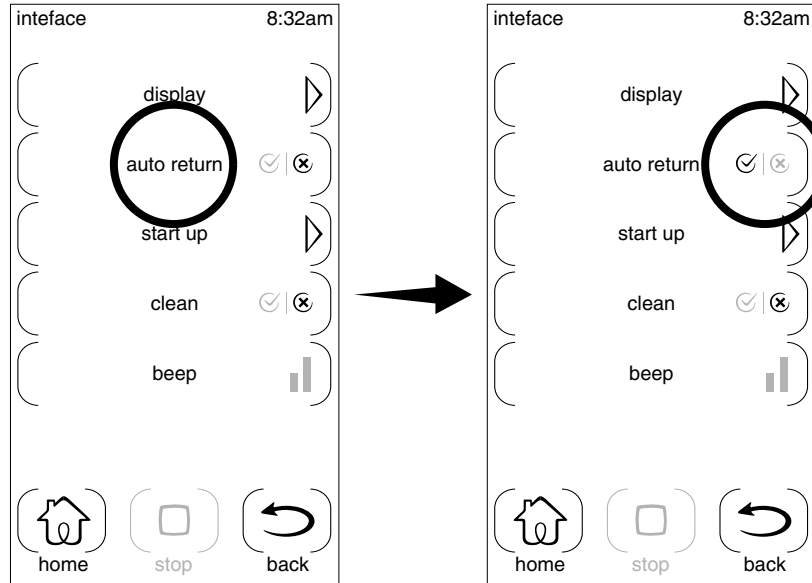

## Interface Settings – Auto Return

**Path:** settings > interface > auto return > on or off

**Factory default:** off (red "x")

**When ON:** Based on the order of precedence, the interface will return to the screen of the highest active feature after 30 seconds of inactivity. The order of precedence is: spa (if equipped), shower, steam, music, lighting, home. If within the [settings] screens, the interface will return to the home screen after 1 minute of inactivity.

**When OFF:** The interface will remain on the current active screen.

- From the home screen, touch the [settings] icon.
- Touch the [interface] option.
- Touch the [auto return] option to turn on (designated by a green checkmark), or off (designated by a red "x").
- Touch the [home] or [back] icon to exit the interface settings menu.

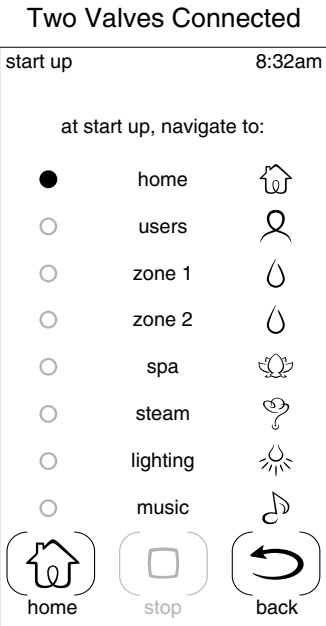
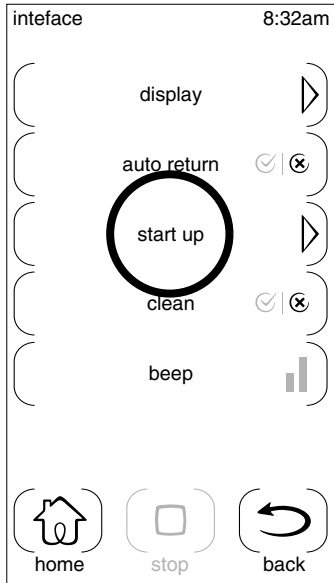

OR



### Interface Settings – Start Up

**Path:** settings > interface > start up

**Function:** sets the screen that appears at start up. For example, when the system turns on, the user may want the interface to initially display zone 1 of the shower feature, rather than the default home screen.

**Factory default:** home

**NOTE:** Depending on system configuration and the number of connected valves, some feature screens may not be available.

- From the home screen, touch the [settings] icon.
- Touch the [start up] option.
- Touch the desired feature screen to display at start up. The radio button to the left of the selected screen will illuminate.
- Touch the [home] or [back] icon to exit the start up menu.

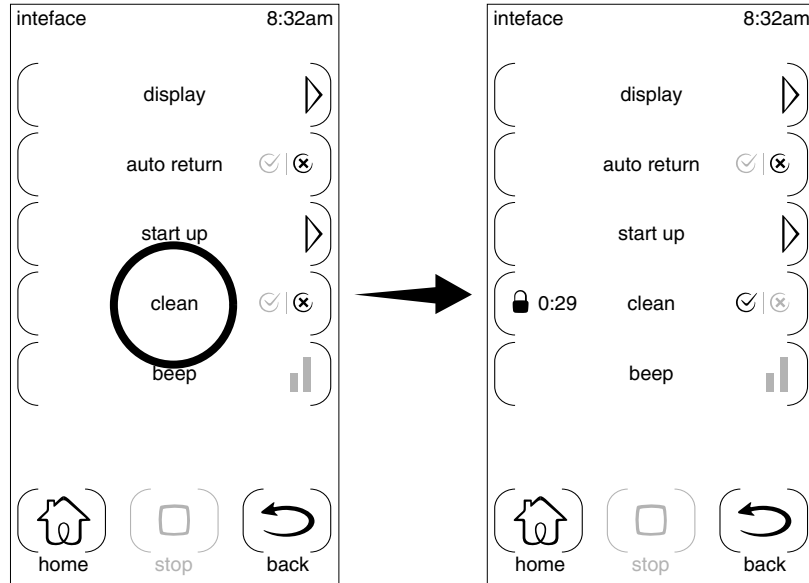

## Interface Settings – Clean (Lock)

**Path:** settings > interface > clean

**Function:** locks the interface for 30 seconds. This allows the screen surface to be cleaned without inadvertently activating a feature or changing a setting.

**NOTE:** The [clean] feature only provides a temporary lock. To block access to interface features, a code can be applied to the interface. The code is enabled from the controller Web pages. Refer to the “Web Settings – System” section.

- From the home screen, touch the [settings] icon.
- Touch the [interface] option, then touch [clean].
- The green checkmark will illuminate and all interface “keys”, including the power icon and the temperature arrows, will lock for 30 seconds.
- The remaining lock time will be displayed next to a padlock icon.
- After 30 seconds, the interface “keys” will automatically unlock.
- Touch the [home] or [back] icon to exit the interface settings menu.

### Access Code

- From the home screen, touch the [settings] icon.
- If an access code is required, a pop-up window will appear, prompting the user to enter the 4-digit code.
- The access code feature is enabled/disabled from the controller Web pages. The code cannot be enabled, disabled, or modified from the interface.
- Touch the [interface] option, then touch [clean].
- The green checkmark will illuminate and all interface “keys”, including the power icon and the temperature arrows, will lock for 30 seconds.
- The remaining lock time will be displayed next to a padlock icon.
- After 30 seconds, the interface “keys” will automatically unlock.



## Interface Settings – Clean (Lock) (cont.)

- Touch the [home] or [back] icon to exit the interface settings menu.

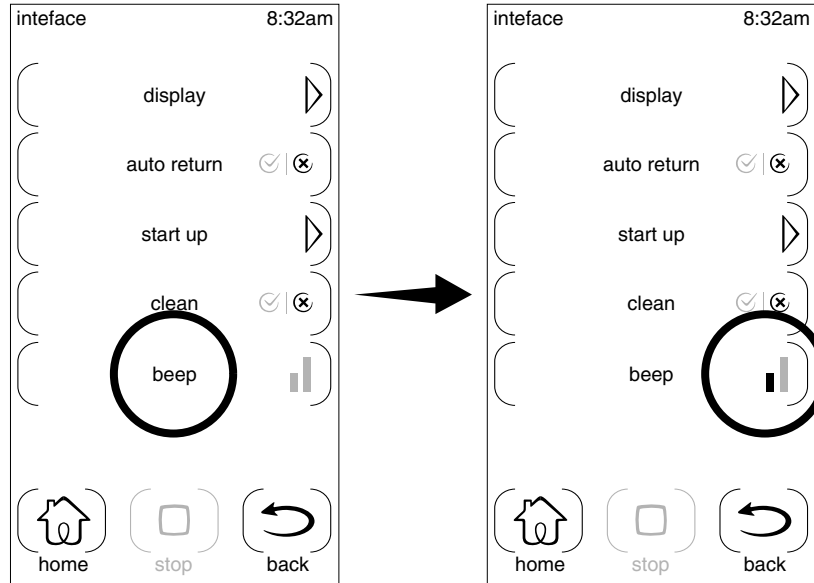

## Interface Settings – Beep

**Path:** settings > interface > beep > off, low, or high

**Function:** adjusts the volume of the interface beeps.

**Factory default:** off

- From the home screen, touch the [settings] icon.
- Touch the [interface] option.
- Touch the [beep] option to change the volume. Touch multiple times to toggle through the volume options:
  - Dimmed bars = off
  - One illuminated bar = low
  - Two illuminated bars = high
- Touch the [home] or [back] icon to exit the interface settings menu.

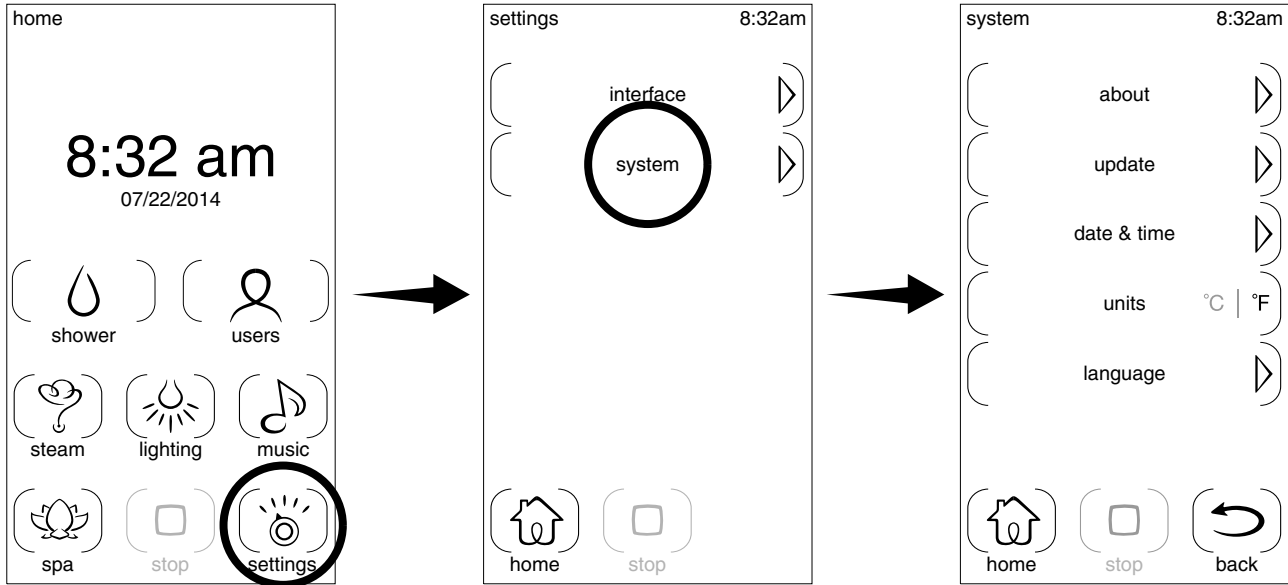

## System Settings – Overview

**Path:** settings > system

**Function:** allows modifications to general system settings and contains information about connected system components. Changes to system settings on one interface will automatically appear on any other connected interfaces.

**NOTE:** The settings menu is not accessible when water is running or steam is on. A “not available” pop-up window will appear if the user touches the [settings] icon while any shower or steam feature is activated.

**NOTE:** Additional system settings beyond those available on the interface can be modified from the system controller Web pages. Refer to the “Web Settings – System” section.

The system settings menu consists of five categories:

- **About** – displays software information for connected system components.
- **Update** – allows manual download of available system software updates.
- **Date & Time** – sets the date and time display.
- **Units** – sets the temperature to display degrees Celsius or Fahrenheit.
- **Language** – selects the interface display language.

- From the home screen, touch the [settings] icon.
- Touch the [system] option.
- Select a category to view/adjust system settings as desired.

**NOTE:** The [back] icon appears on all settings screens. Touch the [back] icon to return to the previous screen.

- Touch the [home] or [back] icon to exit the system settings menu.

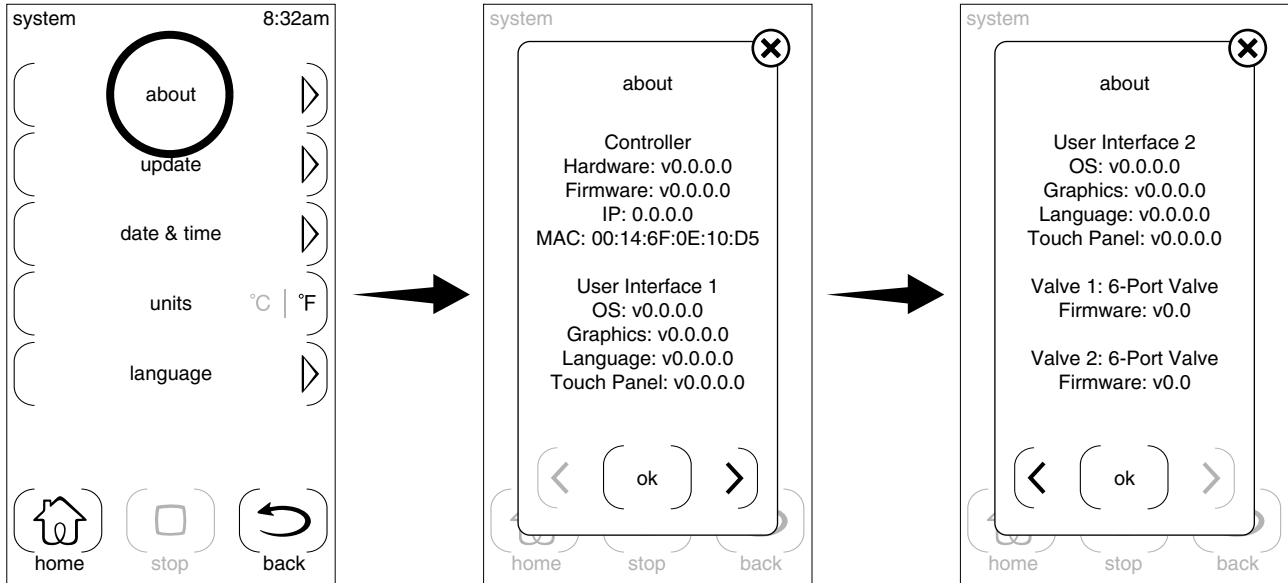

## System Settings – About

**Path:** settings > system > about

**Function:** displays software information for connected system components.

- From the home screen, touch the [settings] icon.
- Touch the [system] option, then touch [about].
- A pop-up window will appear showing software information for any connected components. The information may take a few seconds to appear.

**NOTE:** Depending on the number of connected components, software information may span more than one pop-up window.

- To view additional software information, touch the arrow on the right.
- To return to the previous pop-up window, touch the arrow on the left.
- Touch [ok] or [x] at the top right of the window to exit the [about] pop-up window.

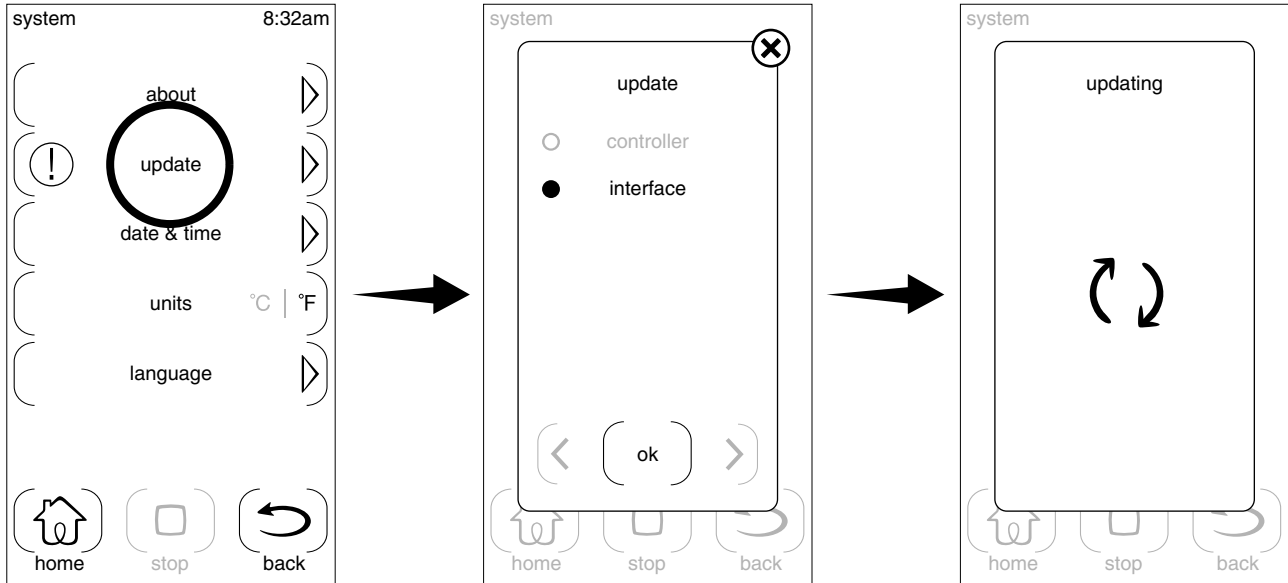

## System Settings – Update

**Path:** settings > system > update

**Function:** allows installation of available system software updates.

**Factory default:** all available updates selected for installation

**IMPORTANT!** Do not disconnect the power from any components during software installation.

**NOTE:** The system controller will check for software updates daily (around midnight), and will automatically download the software. Software can be selected and installed from the interface.

**NOTE:** If an update is available, an exclamation point will appear at the corner of the settings icons that lead to the update window.

- From the home screen, touch the [settings] icon.
- Touch the [system] option, then touch [update].
- A pop-up window will list available updates for any connected system components.

**NOTE:** By default, all available updates are selected for installation. It is recommended that all updates are installed immediately when available.

- If desired, touch components to deselect for update installation.
- Touch [ok] to initiate installation. A rotating arrows icon will appear in the window while the installation takes place.
- Once installation of all component updates is complete, the interface screen will return to the idle screen.

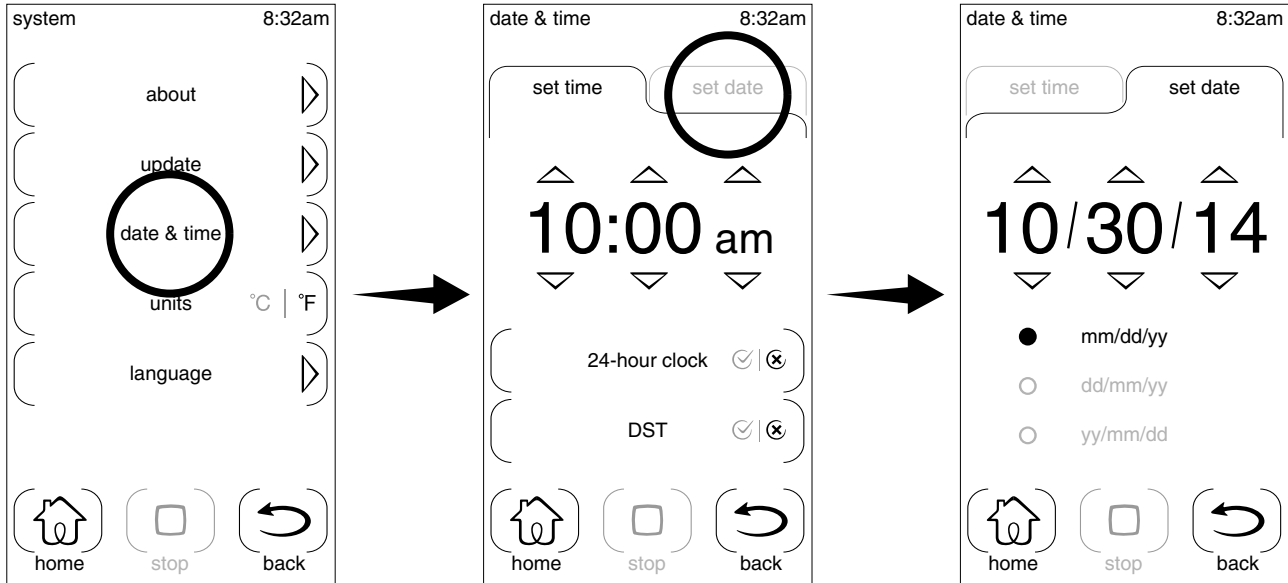

## System Settings – Date & Time

**Path:** settings > system > date & time

**Function:** sets the date and time display.

**Factory default:** 12-hour clock, mm/dd/yy, DST disabled

### Set Time

- From the home screen, touch the [settings] icon.
- Touch the [system] option, then touch [date & time].
- Using the up or down arrow icons, set the hour and minutes, and chose "am" or "pm."
- To change the time display to 24-hours, touch the [24-hour clock] option. The icon at the right will change from a red "x" to a green checkmark.
- To enable daylight savings time, touch the [DST] option to change the icon from a red "x" to a green checkmark. When enabled on the interface, daylight savings time will automatically be enabled on the controller Web pages.

### Set Date

- From the home screen, touch the [settings] icon.
- Touch the [system] option, then touch [date & time].
- Select the [set date] tab.
- Using the up and down arrow icons, set the month, day, and year.
- Touch the desired date format. The radio button for the selected format will illuminate.
  - mm/dd/yy = month/day/year
  - dd/mm/yy = day/month/year
  - yy/mm/dd = year/month/day
- Touch the [home] or [back] icon to exit the date & time menu.

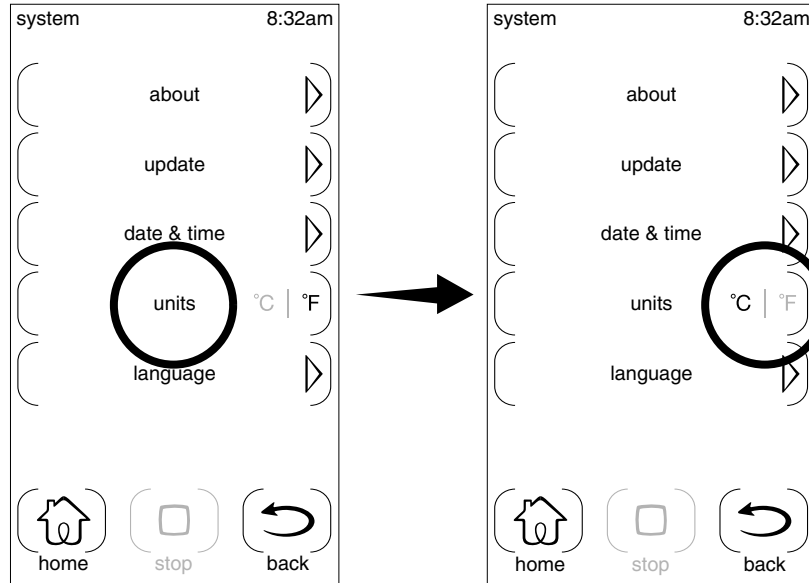

## System Settings – Temperature Unit

**Path:** settings > system > units > °C or °F

**Function:** sets the temperature to display degrees Celsius or Fahrenheit.

**Factory default:** °F

**NOTE:** The temperature is displayed on the interface screen when the shower, steam, spa, and massage features are activated. Temperature can be adjusted at any time while these features are functioning by touching the blue or red arrow.

- From the home screen, touch the [settings] icon.
- Touch the [system] option.
- Touch the [units] option to change the temperature unit to Celsius (°C) or Fahrenheit (°F).
- Touch the [home] or [back] icon to exit the system settings menu.

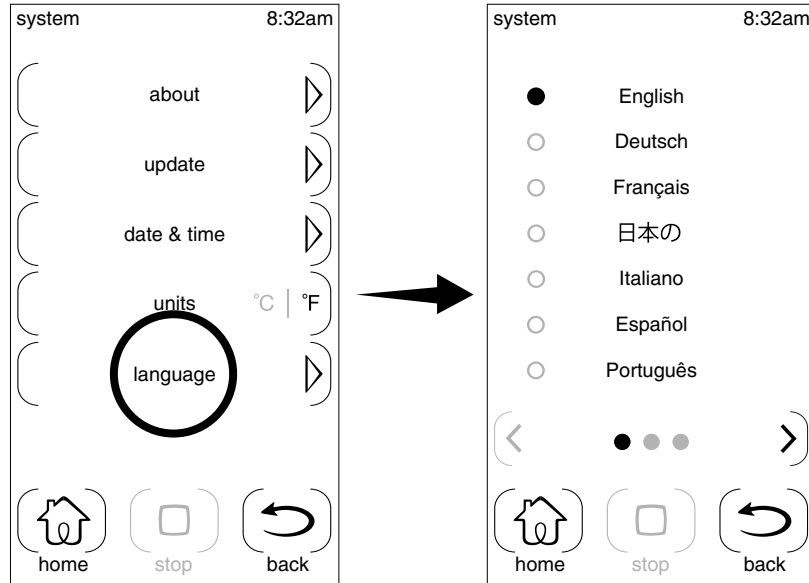

## System Settings – Language

**Path:** settings > system > language

**Function:** selects the interface display language.

**Factory default:** English

**NOTE:** Several interface languages are available. Future software updates will provide additional language options.

**NOTE:** Language selection on one interface will automatically apply to any other connected interfaces, but will not apply to the system controller Web pages. To change the language of the system controller Web pages, refer to the “Web Settings – System” section.

- From the home screen, touch the [settings] icon.
- Touch the [system] option.
- Touch the desired language. The radio button for the selected language will illuminate.
- Touch the [home] or [back] icon to exit the language menu.



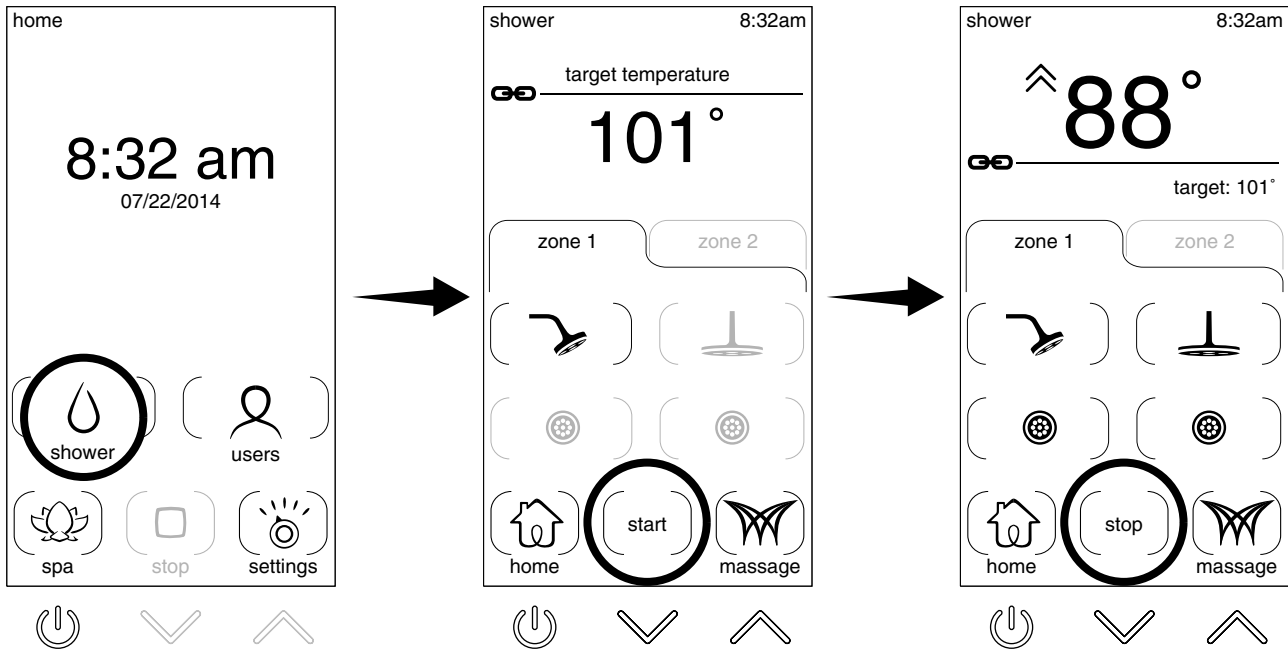

## Shower – Start

**Path:** shower > start

### Enter Shower Features

- From the home screen, touch the [shower] icon.
- The shower screen will appear with the default shower outlet highlighted/selected.
- **For non-Eco systems:** Touch available shower outlet icons to select/deselect other outlets that will turn on when water flow starts.
- **For Eco systems:** Touch an available shower outlet icon to select a different default outlet. Only one outlet can be selected to turn on when water flow starts.
- **Target temperature:** the up/down arrows will be illuminated, allowing adjustment of target temperature before starting water. Refer to the "Shower – Adjust Temperature" section.

### Turn Shower Features On

**NOTE:** If the auto-purge feature is enabled, a [shower warm up] pop-up will appear when the [start] icon is touched. Refer to the "Auto Purge" section.

- On the [shower] screen, touch the green [start] icon to begin water flow from selected/highlighted shower outlet(s).
- A red [stop] icon will appear, indicating that water is flowing from the selected outlets.
- Touch available shower outlet icons to turn other outlets on or off when water is flowing.
- Any running shower outlets will remain on until the [stop] icon is touched.
- **Temperature adjustment:** the up/down arrows will be illuminated, allowing temperature adjustment any time water is running. Refer to the "Shower – Adjust Temperature" section.

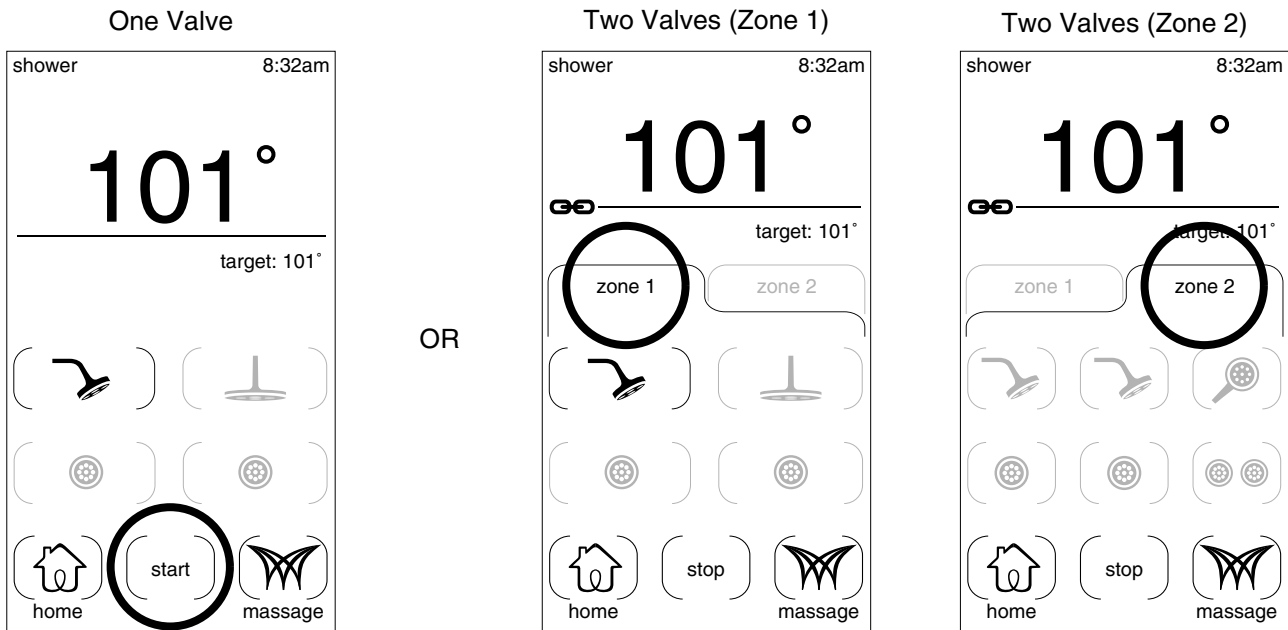

## Shower – Valve Zones

Shower zones will display according to the number of valves hooked up to the system.

### One Valve

- Shower fittings will be displayed directly below the temperature bar.

### Two Valves (Zones)

- Zones will appear when there are two digital valves connected to the shower system.
- **Zone 1:** This zone contains the primary (default) showerhead. In the example shown above, the valve is plumbed to the primary showerhead, a rainhead, and two bodysprays.
- **Zone 2:** To access the second zone, touch the [zone 2] tab. In the example above, the valve is plumbed to the two showerheads, a handshower, two bodysprays, and two foot sprays.
- A link icon will appear in front of the temperature bar. By default both zones are linked.

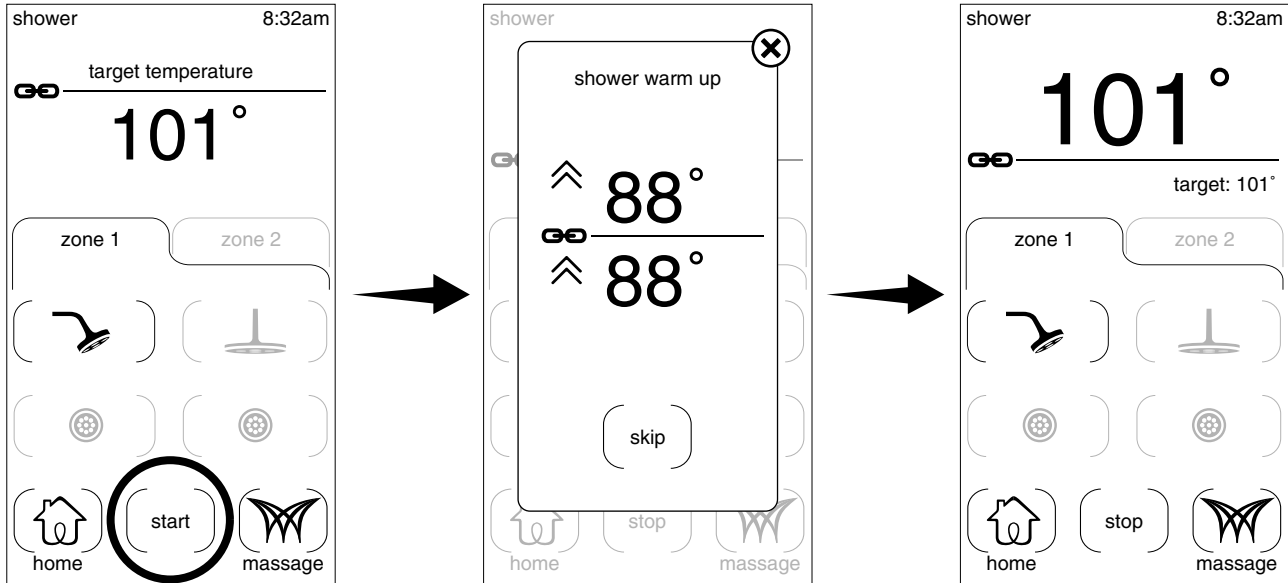

## Shower – Auto Purge

**NOTE:** The auto purge feature must be enabled on the controller Web pages for this feature to activate. Refer to the “Web Settings – Auto Purge” section.

**NOTE:** The image above shows two zones, indicating that two valves are connected to the system.

**Path:** shower > start

**Function:** purges the cold water from the shower lines to reach the set temperature faster. For non-Eco systems, all water outlets (except those designated as a handshower) are turned on at the same time. For Eco systems, only one outlet will purge at a time.

**Factory default:** 7 seconds

The auto purge feature will only activate if the shower has been inactive for 30 minutes or longer.

- From the [shower] screen, touch the green [start] icon to begin the auto-purge feature (if enabled).
- A [shower warm up] pop-up will appear, and enabled outlets will begin running and will continue running until the target temperature is reached, or until the set duration is reached. Refer to the “Web Settings – Auto Purge” section to adjust time duration options.
- The pop-up will display the actual temperature for both zones (for two connected valves).

### Skip Auto Purge

- While auto purge is running, the [shower warm up] pop-up allows the user to bypass the feature.
- All outlets that were not selected before pressing [start], will turn off.
- Outlets that were selected stay on and will continue to rise to and maintain target temperature.
- Touching the [x] at the top right of the pop-up window will cancel auto purge and return to the previous screen.

### If Target Temperature Cannot Be Reached

- The pop-up will display the actual temperature for both zones (for two connected valves).
- User cannot adjust target temperature while purge is running. Will purge to set target temperature.

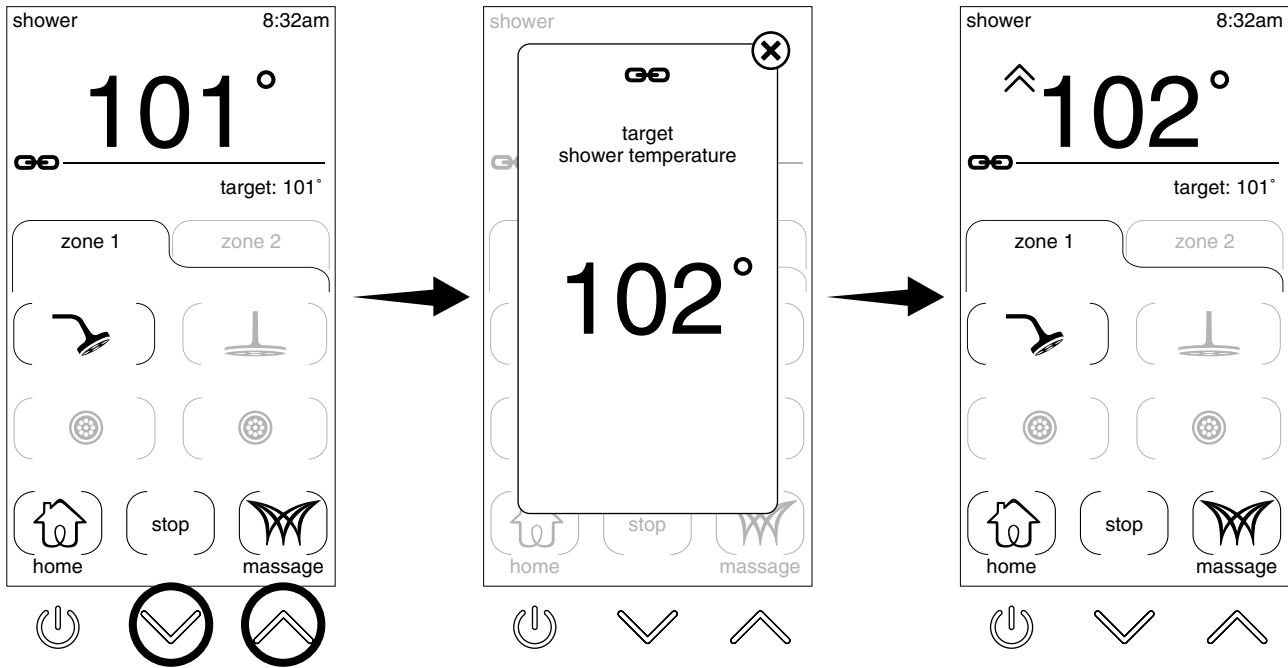

## Shower – Adjust Temperature

**Path:** shower > blue down arrow or red up arrow.

**Function:** allows water temperature adjustment anytime water is flowing from a shower fixture.

- From any screen on the interface when water is running, touch the blue or red temperature arrows below the screen.
- Touch the blue arrow to decrease temperature; touch the red arrow to increase temperature.
- A pop-up window will appear showing the target shower temperature.
- For a multi-valve system, the link icon at the top of the pop-up window indicates whether the target temperature is being adjusted for one valve, or both valves.
- A closed link icon means that the target temperature for both valves is the same, and both will be adjusted at the same time when the arrows are touched.
- An open link icon means that the target temperature for each valve can be adjusted independently.
- To adjust target temperature for each valve independently, touch the link icon to change from a closed link to an open link.

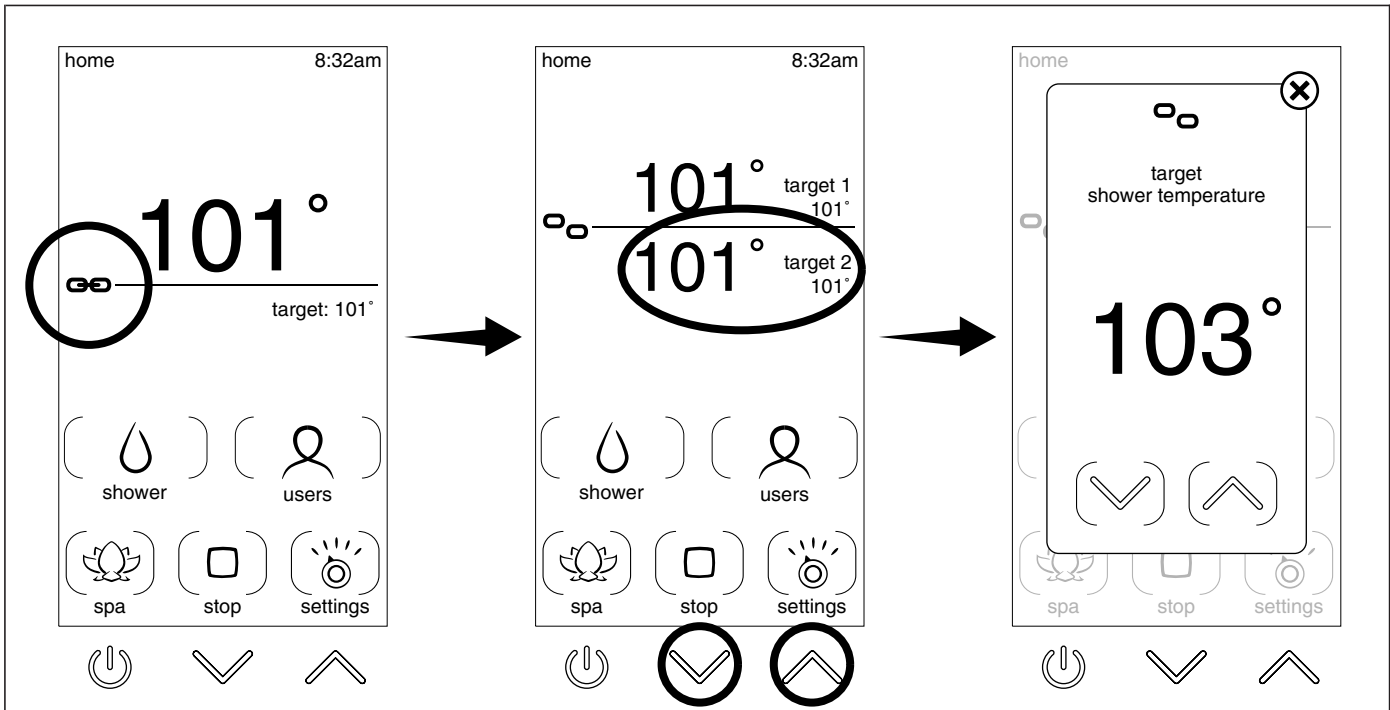

## Shower – Dual Temperature (Multiple Valves Only)

**Path:** shower > [link] icon

**Function:** When a system contains two valves, a link icon will appear in front of the temperature divider line.

### Linked Temperature Between Valves

- When outlets from two valves are on, a link icon will appear in front of the temperature divider line. The icon indicates that the valves are linked at the same temperature.
- When linked, if the temperature is adjusted for one valve, the other valve will automatically be adjusted to the same target temperature.
- If one valve cannot maintain temperature within an acceptable range from the target, the link icon will blink and both valve temperatures will be displayed. The blinking link icon indicates that the system is attempting to keep the temperatures linked.

### To Unlink Temperature Between Valves

- For a two-valve system, an unlinked icon indicates that temperature can be adjusted independently for each valve.
- To unlink the valves, touch the linked icon.
- When unlinked, if the temperature is adjusted for one valve, the other valve will not be affected.

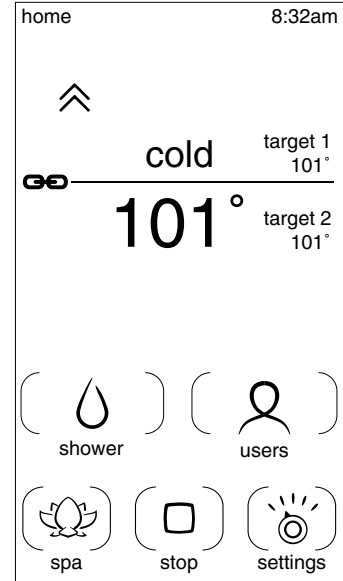
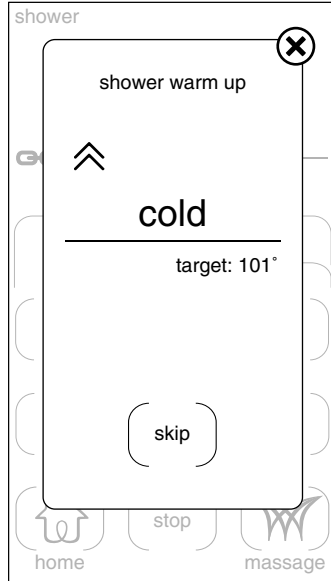
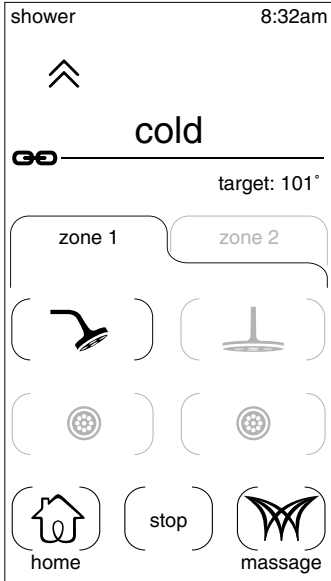

## Shower – Maximum Cold

**Path:** shower

When the water temperature for a valve falls below 86°F (30°C), the word "cold" will be displayed in place of the actual temperature.

**NOTE:** Maximum cold is any temperature below 86°F (30°C). Once temperature rises to 86°F (30°C), the temperature will be displayed in place of the "cold" icon.

- If two valves are running and the temperature for one of the valves drops below maximum cold of 86°F (30°C), the valve temperatures will display separately. The valve that is below 86°F (30°C) will display "cold" in place of the actual temperature. The red chevron (up arrows) indicates that the system is trying to warm to the target temperature.
- The valve temperature displays "cold" when a user attempts to set the temperature lower than 86°F (30°C).

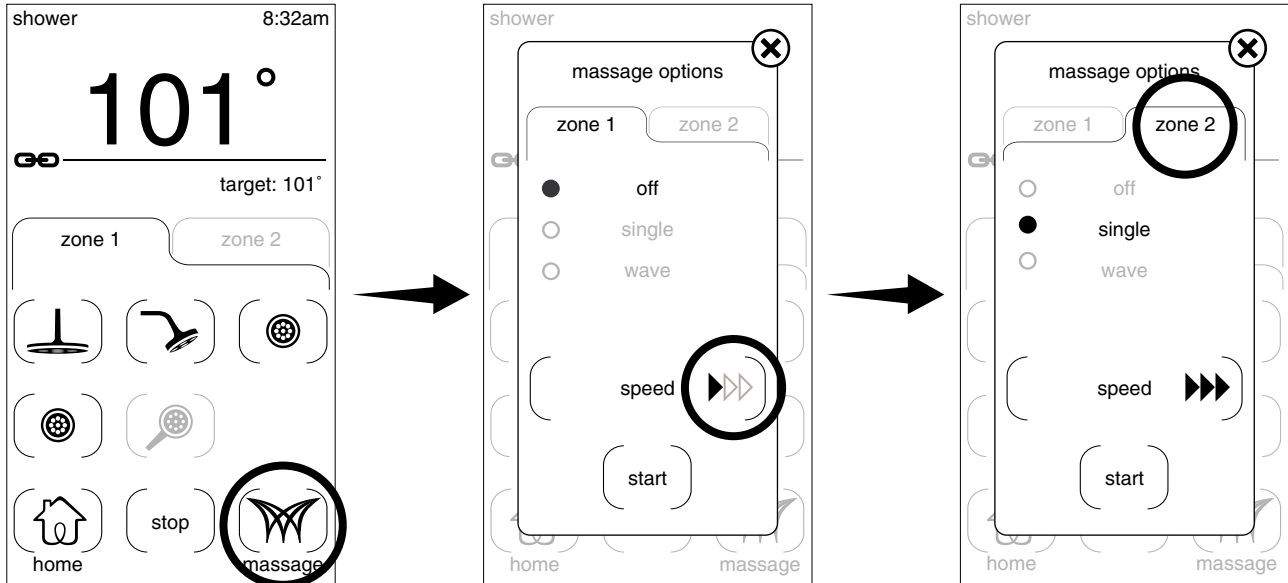

## Shower – Message Setup

**Path:** shower > message

**Function:** activates the message feature.

**Factory default:** off

**NOTE:** To see the [message] icon on the shower screen, the feature must be enabled on the controller Web pages, on both the "System" page, as well as the "Valve" page(s). To enable the message feature, refer to the "Web Settings – System" section and the "Web Settings – Valve" section.

**IMPORTANT!** For proper function, all shower fittings on the same valve that are enabled with message must have total equal flow rates. For example, if one valve outlet supplies water to two bodysprays, the total flow rate of both bodysprays must equal the flow rate of a single fitting supplied by a different outlet.

- From the [shower] screen, touch the [message] icon.
- A pop-up window will appear showing message options. If two valves are connected to the system, the message options are selected independently per zone.
- The pop-up window displays message cycling options (single or wave), and cycling speed.

**NOTE:** Message cycling will only run on shower fittings that have been enabled. To enable the message feature on individual shower fittings, refer to the "Web Settings – Valve" section.

- Touch the [single] or [wave] option to run the message feature.
- **Single:** Circulates water through one shower fitting one at a time.
- **Wave:** Circulates water through all but one shower fitting at a time.
- To change the cycling speed, touch [speed] or the triple arrows to the right. The number of highlighted arrows indicates the speed setting (one arrow = slow, two arrows = medium, three arrows = fast).
- For a two-valve system, the message options must be selected in the [zone 2] tab to activate the message feature on fittings connected to the second valve.

### **Shower – Massage Setup (cont.)**

**NOTE:** The massage cycling feature runs independently on each valve. For example, the [single] option can be run on zone 1 while the [wave] option is run on zone 2. The cycling feature will not span across both zones.



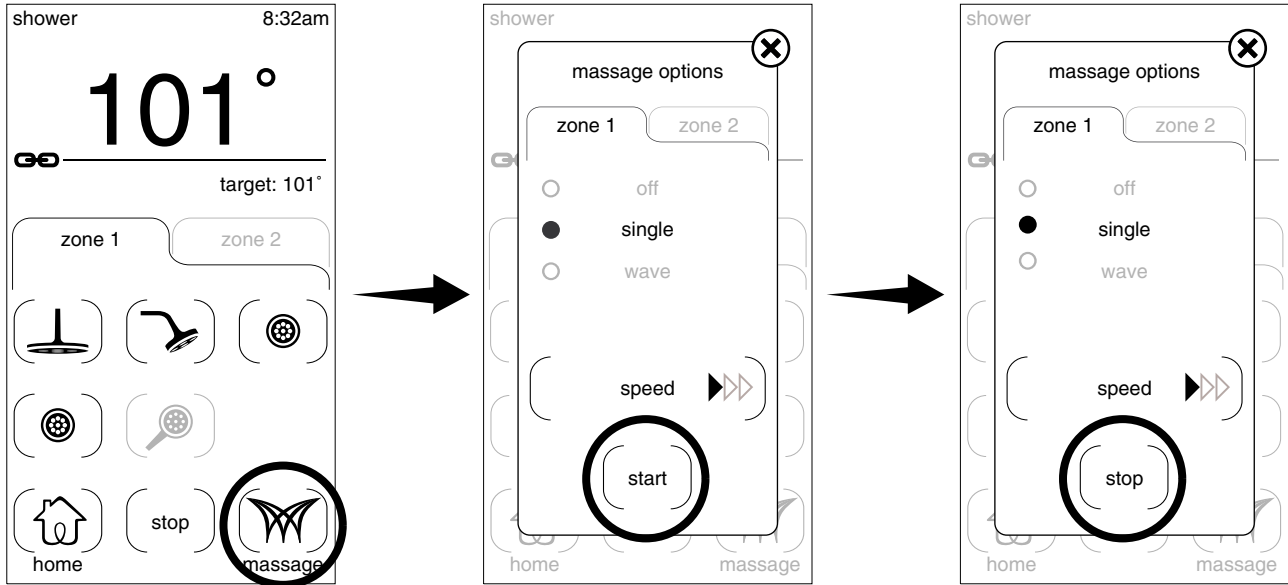

## Shower – Massage Run

**Path:** shower > message

**Function:** activates the massage feature.

**Factory default:** off

- To begin the massage feature, touch [start]. For a two-zone system, this activates massage on both zones.
- If the selected massage option requires more outlets than are currently on, then massage will turn them on based on what is enabled on the controller Web pages.
- The massage feature will continue to run until it is manually stopped.
- To end massage, touch the [message] icon on the shower screen, then touch [stop]. For a two-valve system, this ends massage on both systems.

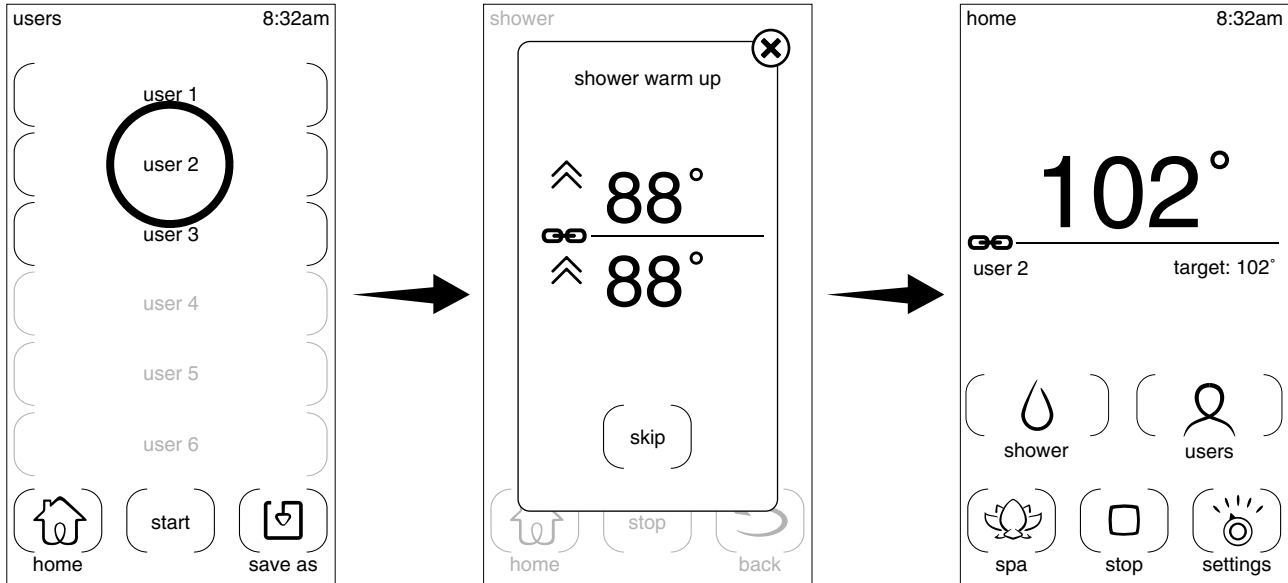

## Users – Setting Preferences

**Path:** settings > users > [choose user 1 through 6].

**Function:** allows quick access to saved user settings and customization of user preferences.

**NOTE:** You do not have to save all settings preferences at one time. You can touch the [save as] icon at any time to save current settings.

User presets can be saved at any time while showering, or set up using the settings menu before showering.

### Using User Presets

- To access previously set user information, touch the [users] icon, then select one of the user presets.
- To save user presets, touch the [save as] icon.

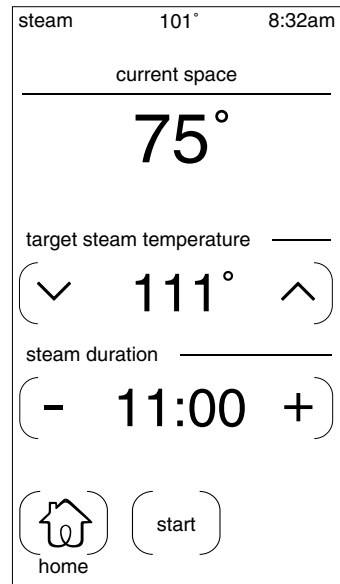
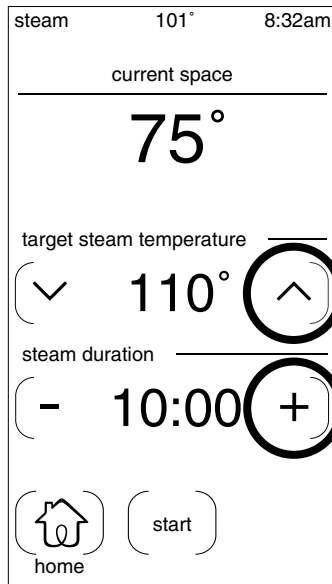

## Steam – Setup

**Path:** steam

**Function:** enables access to the steam feature options. Default steam settings are programmed from the controller Web pages. Refer to the “Web Settings – Steam” section.

**Factory default:** 110°F (43°C) target temperature, 10-minute duration

**NOTE:** To see the [steam] icon on the interface home screen, a KOHLER steam generator must be installed and connected to the system controller, and the feature must be enabled on the controller Web pages. To enable the steam feature, refer to the “Web Settings – System” section.

- From the home screen, touch the [steam] icon.
- Current space = room/ambient temperature. If the temperature is lower than the detectable range, double dashes (--) will be displayed in place of the temperature.
- Target steam temperature can be adjusted using the up or down arrow icons to the left and right. The temperature adjusts in 1°F (or 0.5°C) increments within a range of 90°F (32°C) to 125°F (52°C).
- Steam duration can be adjusted using the minus or plus icons to the left and right. The duration adjusts in 1-minute increments. The maximum set steam duration time is 20 minutes.
- **If water is not running:** The temperature arrows below the screen will not be illuminated.
- **If water is running:** The current water temperature is displayed under “current space” and the temperature adjustment arrows below the screen are illuminated blue and red. The water temperature can be adjusted using the blue and red arrows. Steam temperature must be set using the arrows to the left and right of the target steam temperature.

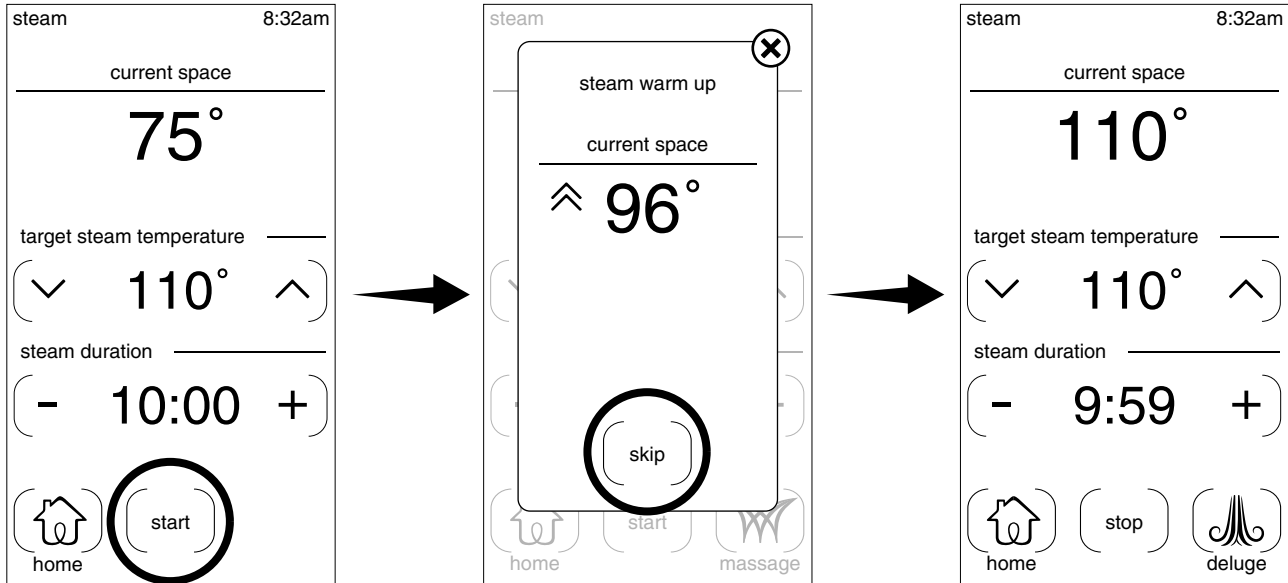

## Steam – Run

**Path:** steam > start

**Function:** activates the steam feature.

**Factory default:** 110°F (43°C) target temperature, 10-minute duration

**NOTE:** To see the [steam] icon on the interface home screen, a KOHLER steam generator must be installed and connected to the system controller, and the feature must be enabled on the controller Web pages. To enable the steam feature, refer to the “Web Settings – System” section.

- From the home screen, touch the [steam] icon.
- If desired, adjust target temperature and duration from the default settings. Refer to the “Steam – Setup” section.
- Touch [start] to begin the steam feature at the parameters designated on the screen.
- A “steam warm up” pop-up window will appear showing the current steam temperature. A red chevron (double arrows) appears next to the temperature display until the temperature is within 5° of the target steam temperature.
- Once warm up is complete, the interface beeps once, the pop-up window disappears, and the steam countdown clock begins counting down.

**NOTE:** If the target temperature cannot be attained, the pop-up window will disappear after 20 minutes, and the steam countdown clock begins counting down. The red chevron will remain, indicating that the target temperature is not reached.

- The steam duration time can be adjusted at any time during the countdown, using the minus and plus icons to the left and right.
- To bypass steam warm up, touch [skip]. The steam feature will begin, and the red chevron (double arrows) will appear next to the current space temperature until the target temperature is reached.

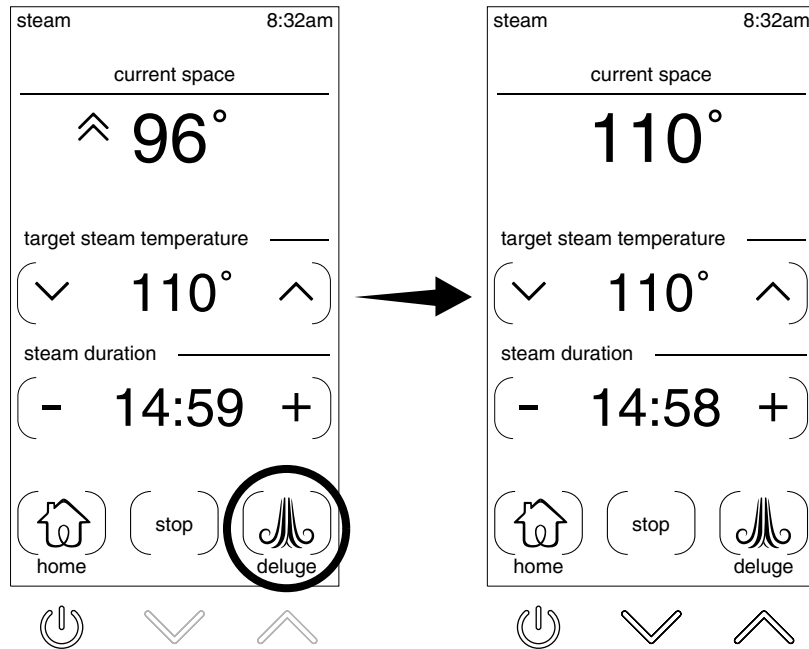

## Steam – Deluge

**Path:** steam > start > deluge

**Function:** activates 10 seconds of water flow from the default showerhead during the steam session. The deluge feature can be activated at any time during a steam session.

**Factory default:** 10 seconds (duration cannot be adjusted).

**NOTE:** To see the [steam] icon on the interface home screen, a KOHLER steam generator must be installed and connected to the system controller, and the feature must be enabled on the controller Web pages. To enable the steam feature, refer to the “Web Settings – System” section.

**NOTE:** The default showerhead is designated in the controller Web pages. For optimal experience, a rain showerhead is recommended for the deluge feature. To change the default showerhead, refer to the “Web Settings – Valve” section.

- From the home screen, touch the [steam] icon.
- Adjust steam target temperature and duration, if desired, then touch the [start] icon.

**NOTE:** The [deluge] icon will not appear until the steam feature is activated.

- Touch the [deluge] icon to turn on water flow to the default showerhead.
- **If water was not running:** the deluge water will rise to the default water temperature.
- **If water was running:** the deluge water temperature will be the same as set temperature for the other active shower fixtures on the same valve.
- The deluge feature will run for 10 seconds. The blue and red temperature arrows are illuminated, allowing adjustment of the water temperature.

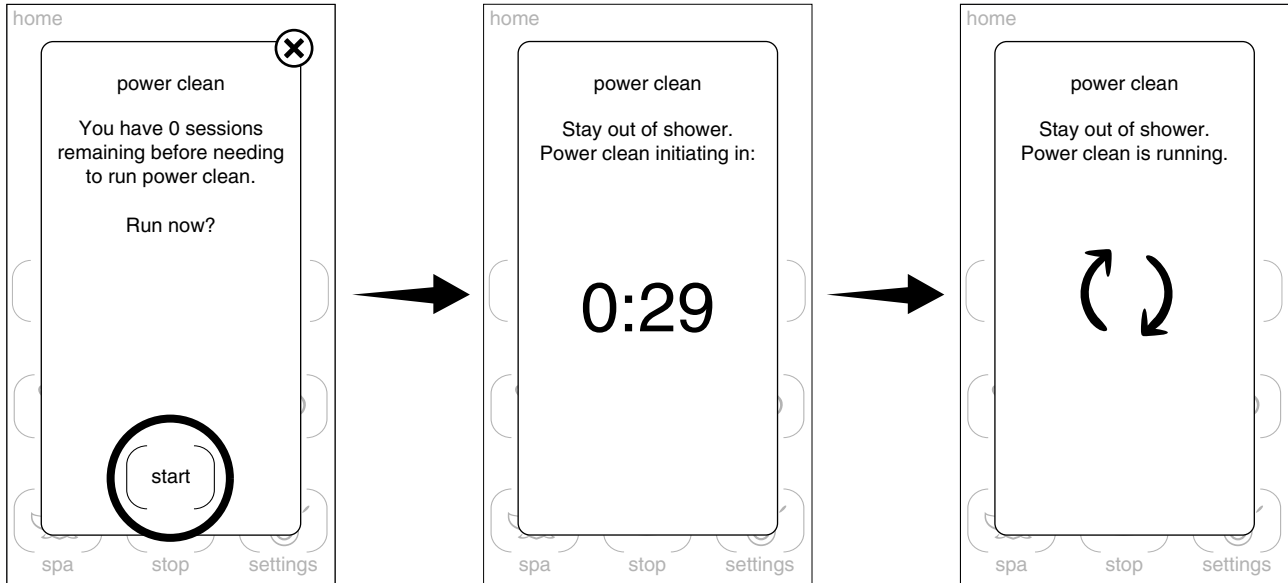

## Steam – Power Clean

**Path:** steam > power clean

**Function:** activates an automatic cleaning procedure for proper, safe maintenance of the steam generator.

**Factory default:** required after 600 minutes

**NOTE:** To see the [steam] icon on the interface home screen, a KOHLER steam generator must be installed and connected to the system controller, and the feature must be enabled on the controller Web pages. To enable the steam feature, refer to the “Web Settings – System” section.

**NOTICE:** The steam system is set to allow for 600 minutes of usage before a cleaning cycle is required. After 600 minutes, your system will bring you directly to the “Power Clean” screen. The cleaning cycle must be completed in order to reset the 600-minute counter and enable steam use.

**NOTICE:** Power clean will run for 45 minutes. Once activated, you must remain out of the steam area until the cleaning cycle has completed.

- From the home screen, touch the [steam] icon.
- If the steam feature has previously been activated for a total of 600 minutes, a [power clean] pop-up window will appear.
- The pop-up window indicates that the power clean feature must be run.

### Start Power Clean

- To initiate the cleaning cycle, touch [start], then exit the steam area immediately.
- The pop-up window will display a 1-minute countdown before cleaning begins.
- When the counter reaches zero, the cleaning cycle turns on and will run for 45 minutes.
- During cleaning, the [power clean] window will display rotating arrows.

**CAUTION:** Stay out of the steam area until the cleaning cycle is complete.

- To cancel the cleaning cycle, touch the power icon. The interface will display the idle screen.

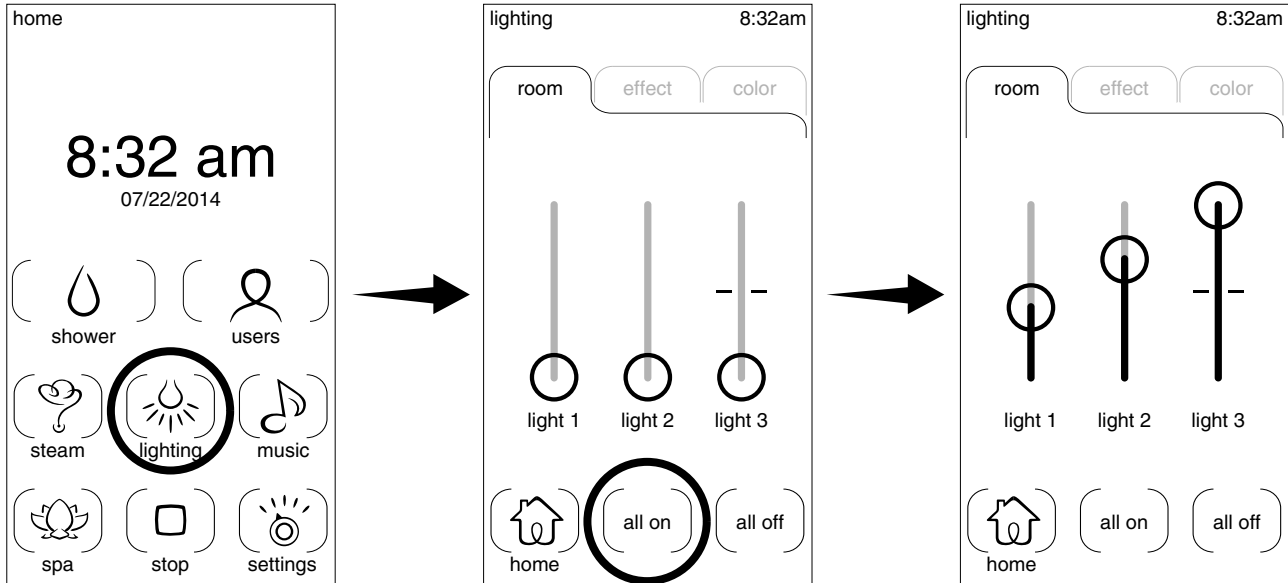

## Lighting – Room

**Path:** lighting > room

**Function:** turns room lighting on or off, and controls dimmable lighting.

**Factory default:** 0% brightness [all off]

**NOTE:** To see the [lighting] icon on the interface home screen, the K-99699 on/off load module and/or K-99700 dimmer load module must be installed to an electrical light switch. The K-99701 lighting bridge must be installed and connected to the system controller, and paired with the load modules.

**NOTE:** Lighting names are designated in the controller Web pages. Refer to the “Web Settings – Room Lighting” section.

- From the home screen, touch the [lighting] icon.

**NOTE:** If the K-98741 ambient rain panel is installed, the lighting menu will display three tabs. Choose the [room] tab to enter the room lighting menu.

- The [room] tab will display up to three sliders, depending on the number of installed and paired load modules.
- **Switch/toggle slider:** appears when the K-99699 on/off module is installed.
- **Dimmable slider:** appears when the K-99700 dimmer module is installed.

### Turn Lights On/Off

- **To turn all lights on:** touch the [all on] icon at the bottom of the screen.
- **To turn individual lights on:** touch the upper half of the slidebar.
- **To turn all lights off:** touch the [all off] icon at the bottom of the screen.
- **To turn individual lights off:** touch the lower half of the slidebar.
- Once selections are made, touch the [home] icon to exit the lighting screen.

### Adjust Dimmable Lights

## Lighting – Room (cont.)

- **To adjust dimmable light:** touch the circle to slide it along the sidebar. Slide up to increase brightness; slide down to decrease brightness.
- Once selections are made, touch the [home] icon to exit the lighting screen.



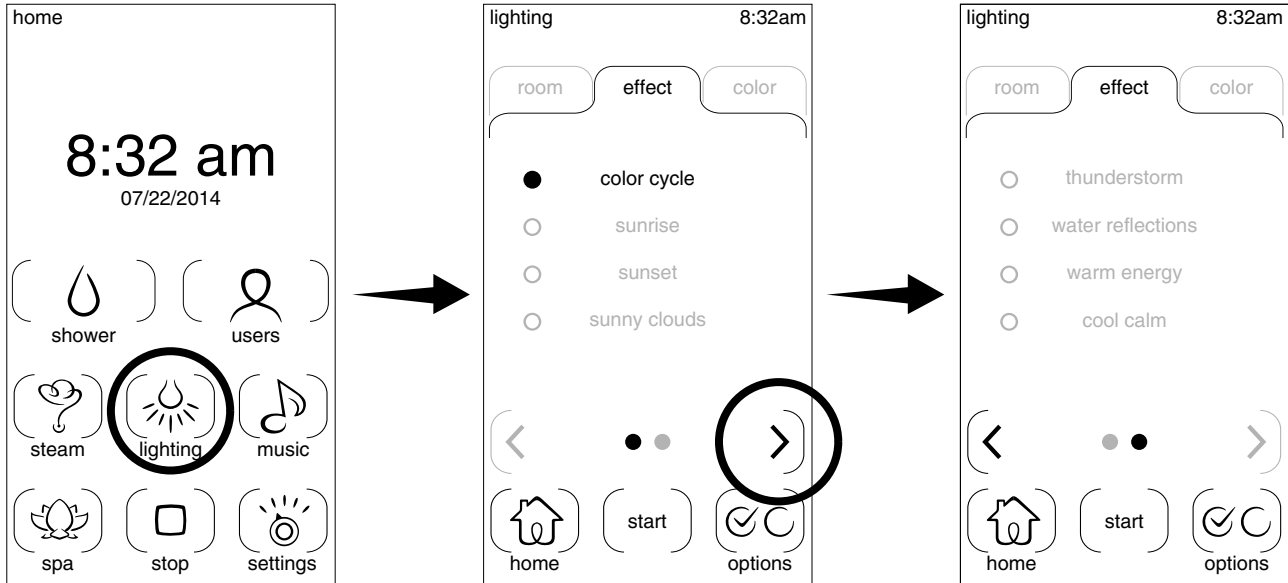

## Lighting – Ambient Rain Effects

**Path:** lighting > effect

**Function:** scripted light sequences are preprogrammed to the ambient rain panel. The user can choose from eight different light (mood) options. Available effects are: color cycle, sunrise, sunset, sunny clouds, thunderstorm, water reflections, warm energy, and cool calm.

**Factory default:** color cycle

**NOTE:** To see the [lighting] icon on the interface home screen, lighting components must be installed and connected to the system controller.

- From the home screen, touch the [lighting] icon.
- The effects tab displays the lighting effects options. To view additional effects, touch the right arrow.
- To return to the previous effects options, touch the left arrow.
- Touch the desired lighting effect. The radio button for the selected effect will illuminate.
- Touch [start] to turn on the rain panel lighting and begin the sequence.
- The green [start] icon will change to a red [stop] icon and the lighting sequence will continue to loop.

**NOTE:** A different lighting effect can be selected at any time while the current effect is running.

- To change to a different light sequence, selected the desired effect, then touch [start]. The light sequence will immediately change to the new effect.

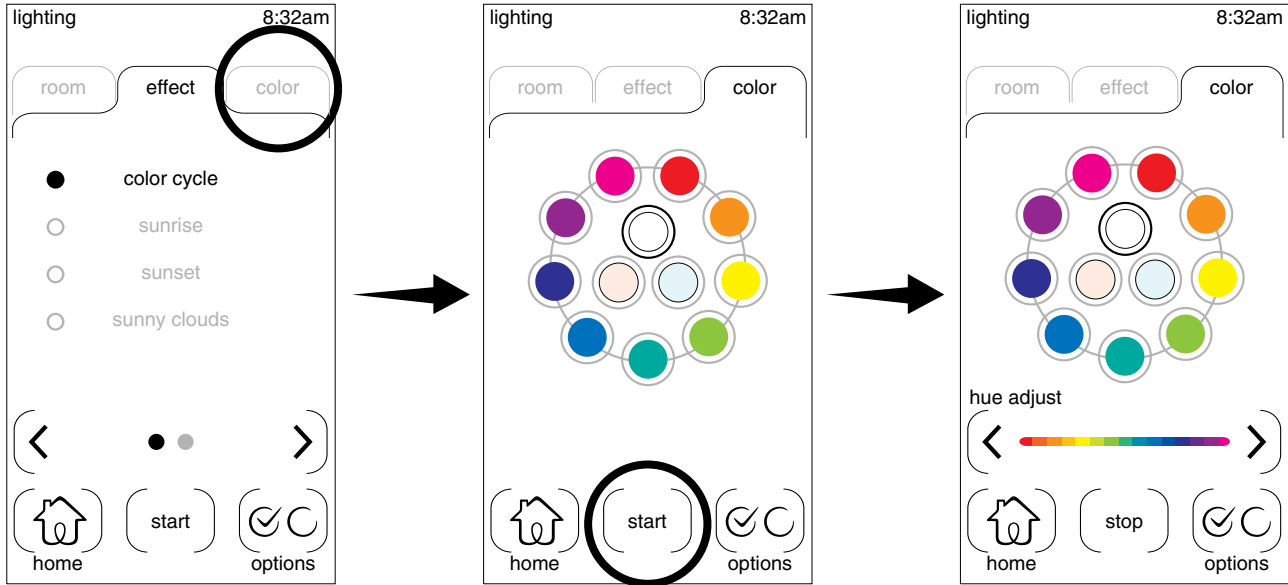

## Lighting – Ambient Rain Color

**Path:** lighting > color

**Function:** sets the color of the rain panel lighting to a selected color.

**Factory default:** neutral white

**NOTE:** To see the [effect] and [color] tabs on the [lighting] screen, the K-98741 ambient rain panel must be installed and connected to the system controller.

- From the home screen, touch the [lighting] icon.
- Touch the [color] tab.
- The color tab displays a color wheel. A hue adjustment bar will also appear once the [start] button is pressed.

### Color Wheel

- The color wheel consists of swatches (circles of color). The inner three swatches are “whites” (neutral, cool, and warm).
- To change the color of the rain panel lighting to a color shown on the wheel, touch the desired color.
- The ring around the selected color will illuminate.
- Touch [start] to turn on the rain panel lighting to the selected color.

### Color (Hue) Adjustment

**NOTE:** The [hue adjust] bar is not accessible when one of the three “whites” is selected inside the color wheel, or when the rain panel lighting is off.

- The [hue adjust] bar is used to change the light color to a hue other than the options shown in the color wheel.
- To adjust the color hue, touch the left or right arrow next to the [hue adjust] bar.

### **Lighting – Ambient Rain Color (cont.)**

- The color shifts in 5° increments based on the color wheel. The left arrow shifts the color counterclockwise along the wheel. The right arrow shifts the color clockwise. For example, if the green swatch was initially selected, one touch of the left arrow will shift the color toward the yellow swatch by 5°.
- The new color changes immediately as the hue is adjusted.

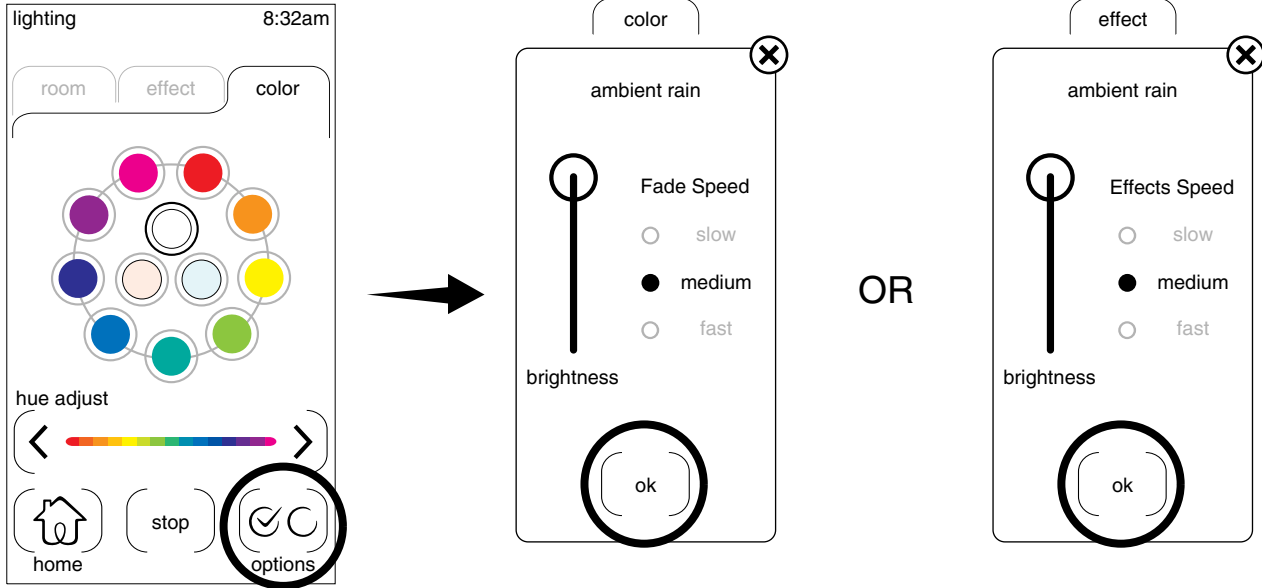

## Lighting – Ambient Rain Options

**Path:** lighting > color (or effect) > options

**Function:** controls the brightness, fade speed, and effect speed of the rain panel lighting.

**Factory default:** 100% brightness, medium speed

**NOTE:** To see the [effect] and [color] tabs on the [lighting] screen, the K-98741 ambient rain panel must be installed and connected to the system controller.

**NOTE:** The [options] icon is available on both the [effect] tab and the [color] tab of the [lighting] screen.

- From the [home] screen, touch the [lighting] icon.
- Touch the [options] icon.
- A pop-up window will appear showing a brightness bar and three fade speed options.
- **To change the brightness:** touch the circle to slide it along the bar. Slide up to increase brightness; slide down to decrease brightness.
- **To change the fade/effect speed:** touch [slow], [medium], or [fast]. The selected option and associated radio button will be highlighted.
- Once selections are made, touch the [ok] icon to exit the options pop-up window.

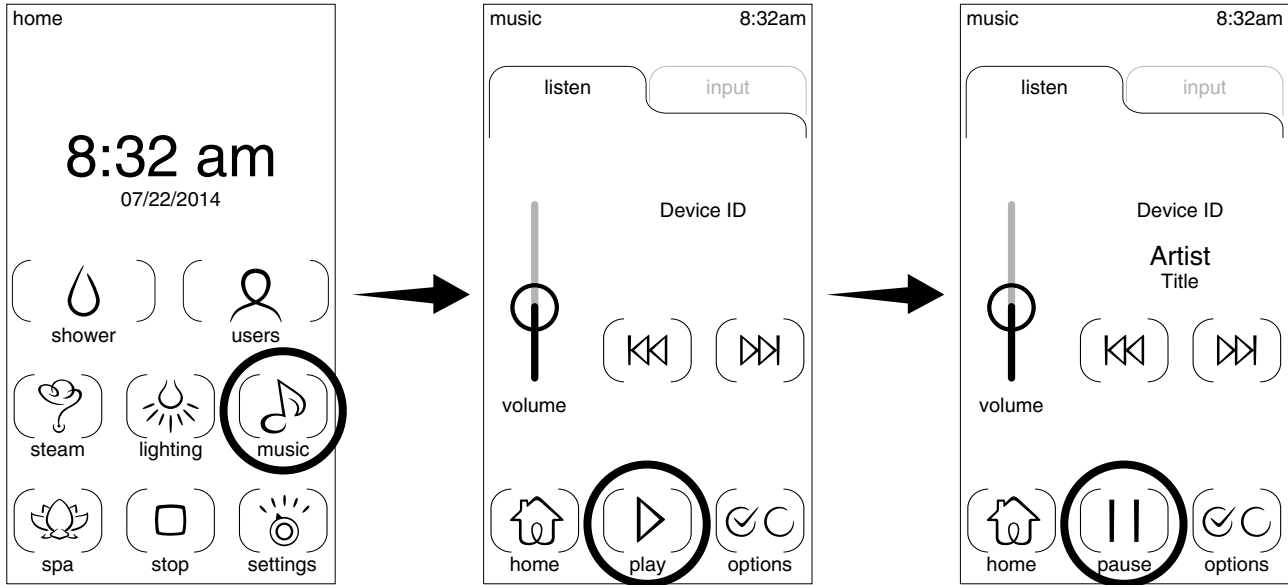

## Music – Controls

**Path:** music > listen

**Function:** allows adjustments to an audio signal from a device connected to the amplifier.

**NOTE:** To see the [music] icon on the interface home screen, the K-99696 amplifier must be installed and connected to the system controller. To hear audio signals through the amplifier, speakers must be properly connected to the amplifier. Refer to the amplifier Installation and Care Guide.

- From the [home] screen, touch the [music] icon.
- The [listen] tab is displayed which contains information for any connected device, and controls for playing and adjusting an audio signal.
- If paired to a Bluetooth device, the device ID (name) will be displayed.
- To play music from a connected device, touch the [play] icon.
- While music is playing, the song artist and title will display below the device ID if the streaming source provides that information.
- To pause the audio sound, touch the [pause] icon. To begin playing again, touch the [play] icon.

**NOTE:** For a radio and line-in source, the pause option will not pause a currently playing song. Touching the [play] icon will resume the audio source to "real time".

- To adjust the volume, touch the circle to slide it along the bar. Slide up to increase volume; slide down to decrease volume.

**NOTE:** If volume control is limited, the volume level may need to be adjusted on the source device.

- Depending on the streaming source, the backward/forward arrows will either skip to the previous/next song, track, or station. The forward arrow does not allow rapid advance of the audio signal.

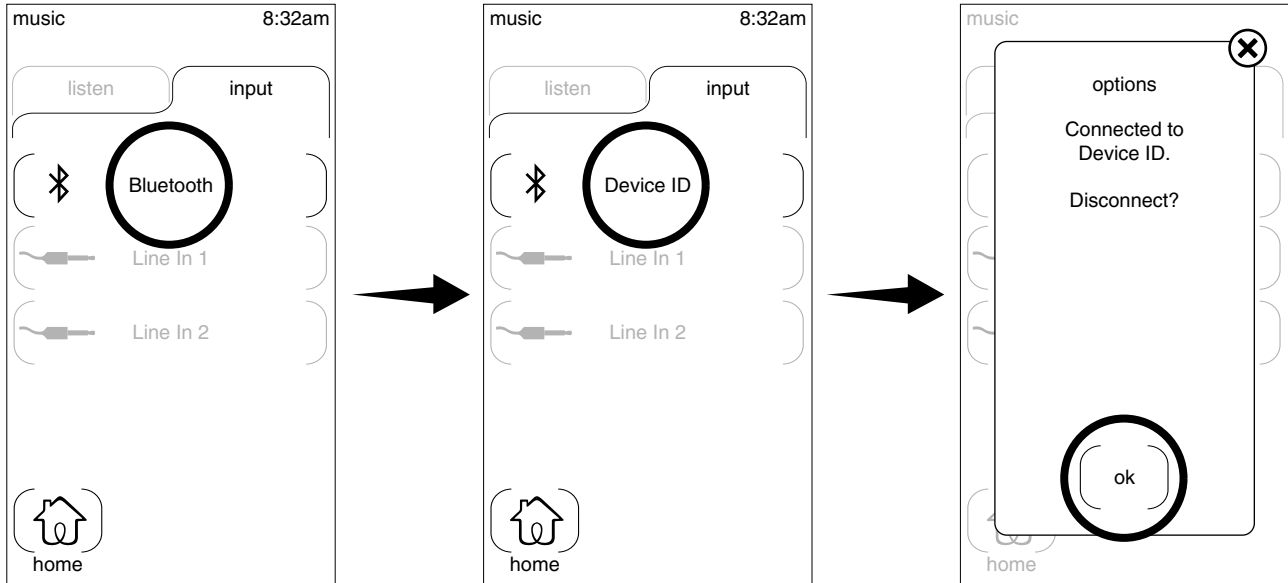

## Music – Bluetooth Input

**Path:** music > input > Bluetooth

**Function:** enables access to a signal from an audio device with a Bluetooth connection to the amplifier.

**NOTE:** To see the [music] icon on the interface home screen, the K-99696 amplifier must be installed and connected to the system controller. To hear audio signals through the amplifier, speakers must be properly connected to the amplifier. Refer to the amplifier Installation and Care Guide.

**NOTE:** All settings for Bluetooth pairing are controlled on the embedded Web pages. Refer to the “Web Settings – Music” section.

- From the home screen, touch the [music] icon.
- Touch the [input] tab.
- Touch the [Bluetooth] option. A Bluetooth device can now be paired.

**NOTE:** The amplifier will display on the device as “KOHLER KA02.” If a BLUETOOTH pin is required, enter “0000.”

- When the device is paired and connected, the device ID (name) is shown in place of the “Bluetooth” option, and the LED on the amplifier will blink blue.
- Once a signal is detected from the Bluetooth device, the LED on the amplifier will turn solid blue.
- To disconnect from the Bluetooth device, touch the device ID. A pop-up will appear to allow disconnection.

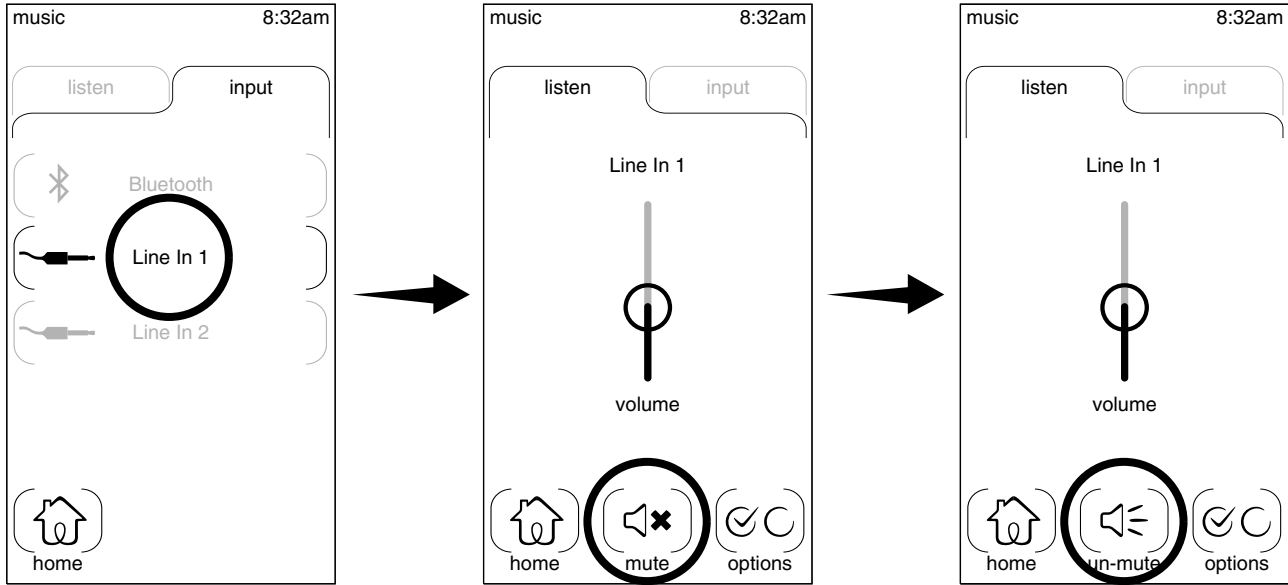

## Music – Line-In Input

**Path:** music > input > line-in 1 (or line-in 2)

**Function:** enables access to a signal from an audio device with a wired connection to one of the line-in ports on the amplifier.

**NOTE:** To see the [music] icon on the interface home screen, the K-99696 amplifier must be installed and connected to the system controller. To hear audio signals through the amplifier, speakers must be properly connected to the amplifier. Refer to the amplifier Installation and Care Guide.

- From the home screen, touch the [music] icon.
- Touch the [input] tab.
- Touch the [line-in 1] or [line-in 2] option.
- Once a signal is detected from the connected device, the LED on the amplifier will turn green and the audio signal should be heard.
- If the LED does not turn green when the device is turned on, increase the volume on the device.

**NOTE:** Audio input may be slightly delayed when a device is initially connected.

- To silence the audio sound, touch the [mute] icon. To regain the sound, touch the [un-mute] icon.
- To adjust the volume, touch the circle to slide it along the bar. Slide up to increase volume; slide down to decrease volume.

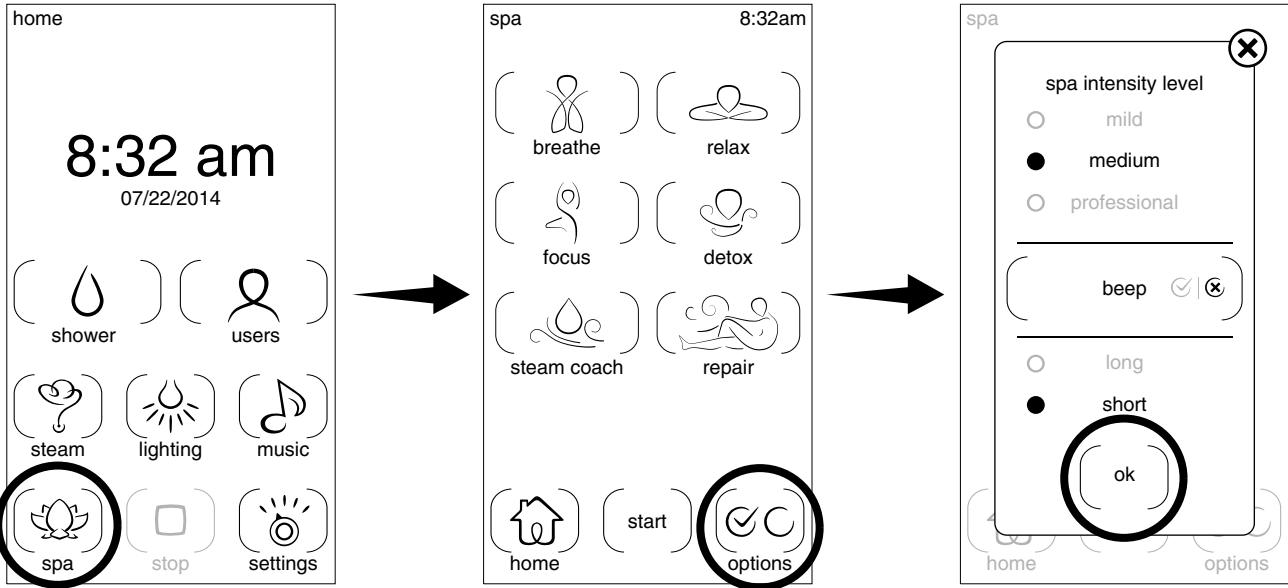

## Spa – Setup

**Path:** spa > [choose experience] > options.

**Function:** allows selection of spa intensity level, beep setting, and duration.

**Factory default:** medium, beep off, short.

**NOTE:** For the [spa] icon to be displayed on the interface home screen, spa must be enabled on the controller Web pages. To enable the spa feature, refer to the “Web Settings – System” section.

**NOTE:** Spa can be initiated whether shower is on or off. The spa feature will override running shower features, including massage. It will also override any active timers.

- From the home screen, touch the [spa] icon.
- The spa menu is populated based on shower configuration and installed fittings. Several spa experience options may be available depending on valve configuration.
- To select a spa experience, touch one of the available options on the [spa] screen. Only one experience can be selected at a time.
- Touch the [options] icon to change spa intensity and duration as desired.
- A pop-up window will appear displaying the available choices.
- Touch the desired spa option, then touch the green [start] icon to begin the experience.
- To bypass shower warm up, touch [skip].
- While a spa experience is running, the interface screen displays several indicators:
  - **Intensity:** dictates the rate at which the experience runs.
  - **Beep:** when enabled, the interface will beep once at the end of each segment of the spa experience.
  - **Duration:** long and short time durations are available for each spa experience. The long time frame is 10 minutes the short time frame is 5 minutes.
- To apply the selected options, touch the [ok] icon. This does not initiate the spa feature. To start a spa experience, refer to the “Spa – Start” section.



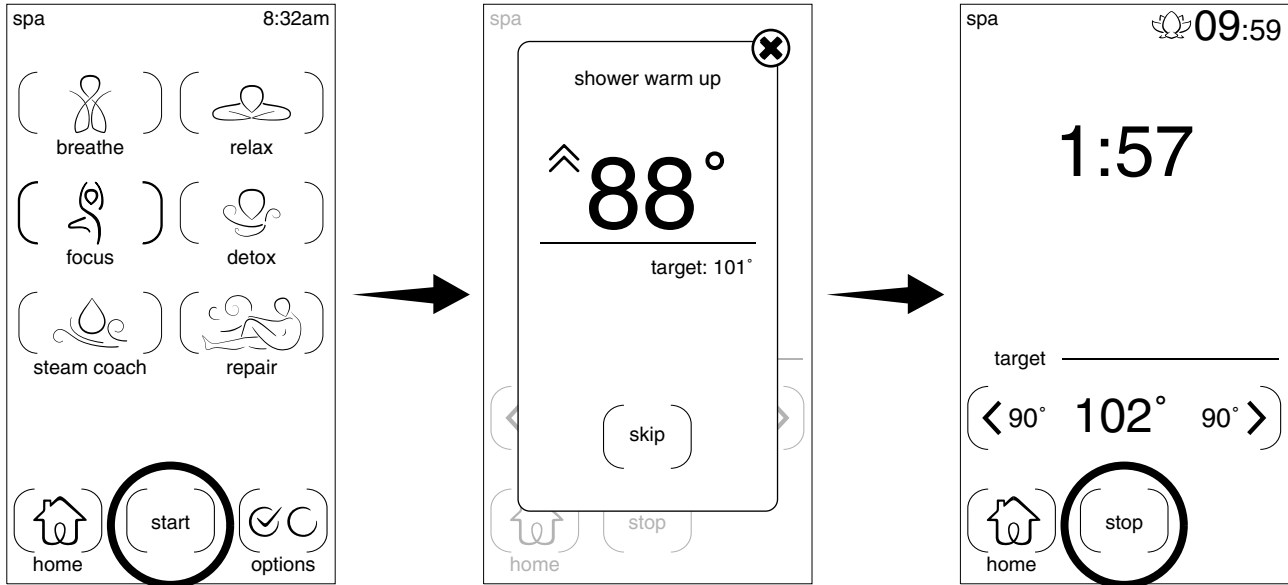

## Spa – Start

**Path:** spa > [choose experience] > start.

**Function:** initiates a spa experience.

**Factory default:** off.

**NOTE:** For the [spa] icon to be displayed on the interface home screen, spa must be enabled on the controller Web pages. To enable the spa feature, refer to the “Web Settings – System” section.

**NOTE:** Spa can be initiated whether shower is on or off. The spa feature will override running shower features, including massage. It will also override any active timers.

- From the home screen, touch the [spa] icon.
- The spa menu is populated based on shower configuration. Several spa experience options may be available depending on valve configuration.
- To select a spa experience, touch one of the available options on the [spa] screen. Only one experience can be selected at a time.
- Touch [start] to begin the experience.
- If water was not running, a “shower warm up” pop-up window will appear showing the current water temperature. A red chevron (double arrows) appears next to the temperature display until the target temperature is reached.
- To bypass shower warm up, touch [skip].
- While a spa experience is running, the interface screen displays several indicators:
  - **Timer:** the total remaining time of the spa experience is displayed at the top right corner of the screen.
  - **Countdown clock:** spa experiences consist of segments (phases). The remaining time of each segment is displayed in the middle of the screen.
  - **Target timeline:** under the [target] bar, temperatures shown in the middle are targets for the current spa segment. Temperatures at the left are targets for the previous segment, and to the right are targets for the next segment.

## Spa – Start (cont.)

- To end a spa experience before the time duration is reached, touch the [stop] icon. All water will be turned off.

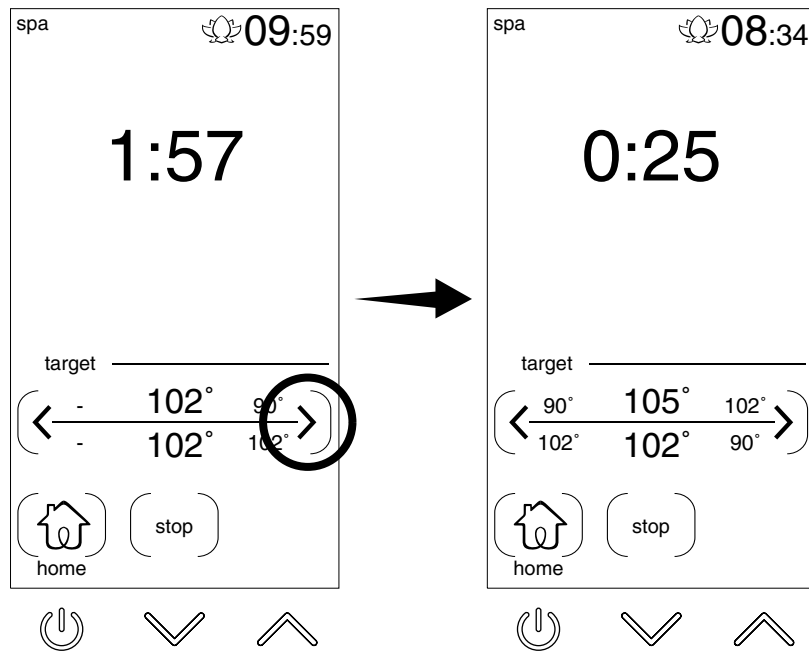

## Spa – Adjust Script

**Path:** spa > [choose experience] > start

**Function:** allows alterations to preprogrammed spa scripts (temperature and segment duration).

**NOTE:** For the [spa] icon to be displayed on the interface home screen, spa must be enabled on the controller Web pages. To enable the spa feature, refer to the “Web Settings – System” section.

**NOTE:** Spa can be initiated whether shower is on or off. The spa feature will override running shower features, including massage. It will also override any active timers.

### Adjust Spa Temperature

- While a spa experience is running, the interface screen displays target temperature information for previous, current, and next spa segments.
- The current target temperature is displayed in the middle.
- The temperature can be adjusted any time during the spa experience.

**NOTE:** Adjustments to the current target temperature also apply to target temperatures for any remaining spa segments. The adjustments are applied to the next segment target temperatures at the same differential. For example, if the current target is adjusted 2° higher, any remaining segment targets will also adjust 2° higher.

- To adjust the target temperature(s), touch the blue or red temperature arrows next to the power icon.
- A pop-up window will appear showing the target temperature(s) changing.

**NOTE:** Zones are linked for spa experiences using a two-valve system. If the temperature is adjusted for one zone, it will also be adjusted for the second zone.

- Once the new target temperature is reached, the pop-up window disappears, returning the interface to the spa screen.
- The new target temperatures are displayed for the current and any remaining segments.

### Adjust Spa Segments

### **Spa – Adjust Script (cont.)**

- While a spa experience is running, the target timeline displays backward and forward arrows. These arrows allow jumping to previous or next steps.
- Touch the back arrow to restart the current spa segment (if active for less than 5 seconds), or jump to the previous segment (if active for more than 5 seconds).
- Touch the forward arrow to jump to the next segment.
- Whether a segment is restarted or jumped to, the countdown clock for that segment restarts, the temperature adjusts to the segment targets, and any associated outlets for that segment are activated/deactivated.

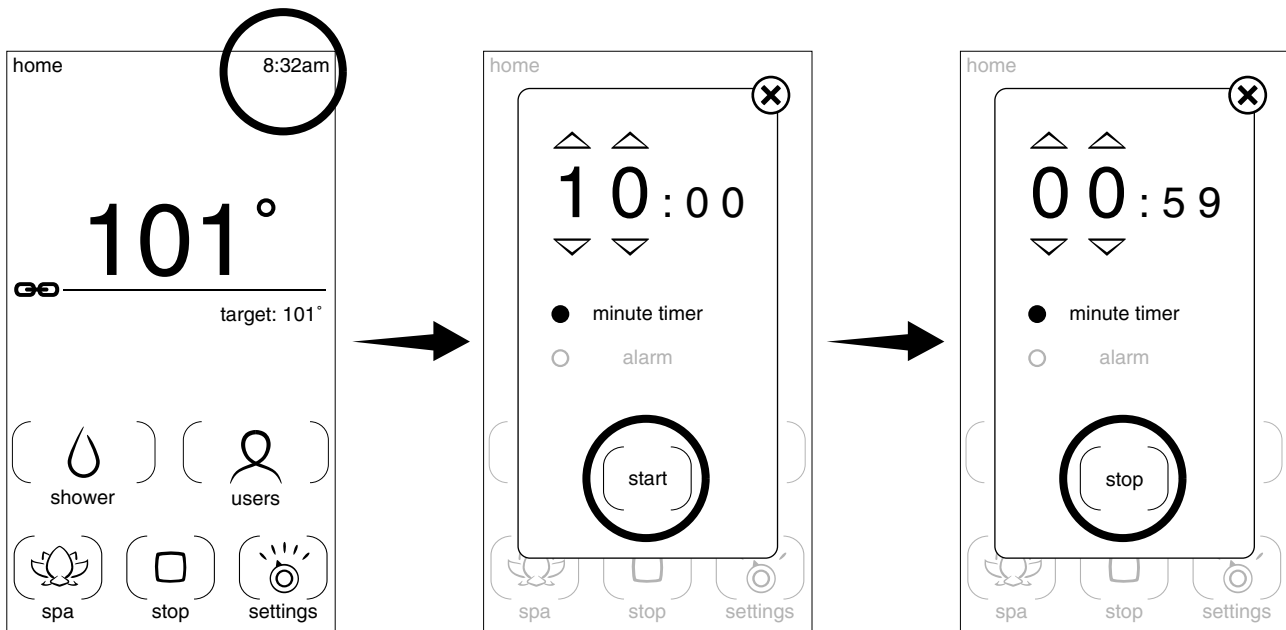

## Time – Minute Timer

**Path:** [time clock]

**Function:** displays a countdown clock and sets the interface to beep after a specified duration of time.

**Factory default:** 10 minutes

**NOTE:** The [minute clock] provides a beep trigger only. It will not turn off any active features. To turn features off, refer to the "Interface – Turn Features Off" section.

### Set the Timer

- Touch the time clock on any screen.

**NOTE:** The clock is located above the home screen icons, or at the right top corner of all other screens.

- A pop-up window will appear showing the current time.
- Touch the [minute timer] option.
- To adjust the time duration, touch the up or down arrow. The time adjusts in 1-minute increments. Seconds cannot be changed.
- Touch [start] to begin the timer. The pop-up window will disappear, returning the interface to the previous screen.
- While the timer is on, a countdown clock appears in place of the time clock on the home screen.
- When the specified time period has elapsed, the pop-up window appears with the countdown clock at zero, and the interface will beep every 10 seconds.
- The beeps cease after 2 minutes, or when the user touches [ok], [x], or the power icon.

### Cancel the Timer

- To stop the timer before the time period has expired, touch the countdown clock or the time clock on any screen.
- The pop-up window will appear showing the countdown clock.

### **Time – Minute Timer (cont.)**

- Touch [stop] to cancel the minute timer. The pop-up window will disappear, returning the interface to the previous screen.

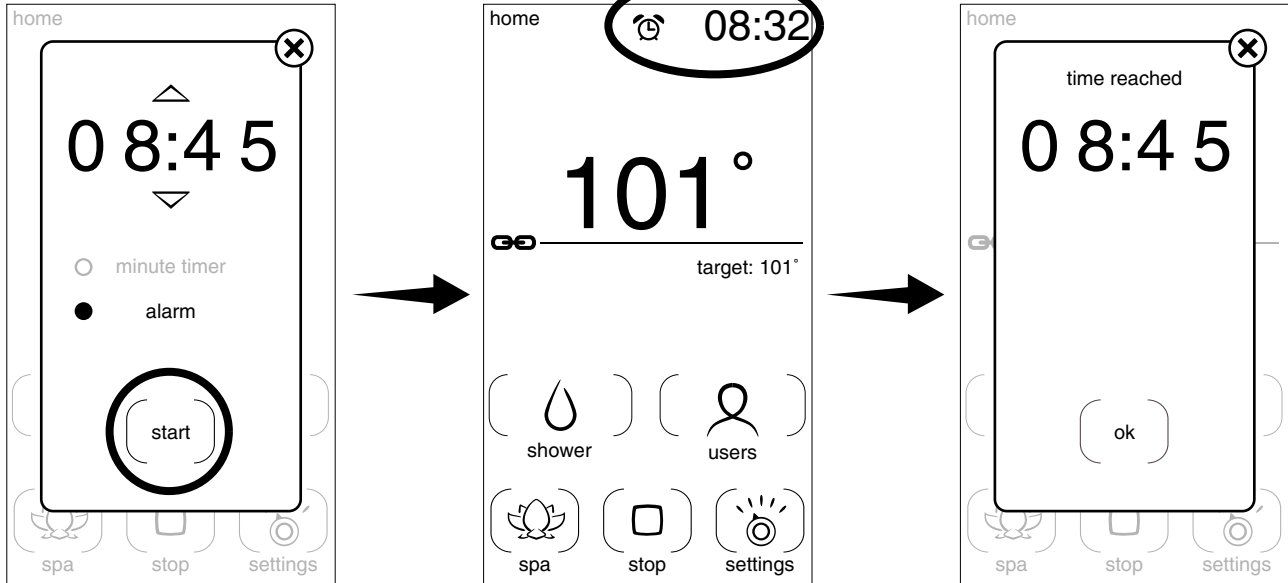

## Time – Alarm Clock

**Path:** [time clock]

**Function:** sets the interface to beep at a designated time.

**NOTE:** The alarm feature provides a beep trigger only. It will not turn off any active features. To turn features off, refer to the "Interface – Turn Features Off" section.

### Set the Alarm

- Touch the time clock on any screen.

**NOTE:** The clock is located above the home screen icons, or at the right top corner of all other screens.

- A pop-up window will appear showing the current time.
- Touch the [alarm] option.
- To program the alarm time, touch the up arrow. The time adjusts in 1 minute increments each time the arrow is touched.
- Touch [start] to turn the alarm on. The pop-up window will disappear, returning the interface to the previous screen.
- While the alarm is on, an alarm clock icon appears in front of the time clock.
- When the time display reaches 1 minute before the alarm time, the interface will beep once.
- When the alarm time is reached, the pop-up window appears showing the current time, and the interface will beep every 10 seconds.
- The beeps cease after 2 minutes, or when the user touches [ok], [x], or the power icon.

### Cancel the Alarm

- To stop the alarm, touch the time clock on any screen.
- The pop-up window will appear showing the programmed alarm time.
- Touch [stop] to cancel the alarm. The pop-up window will disappear, returning the interface to the previous screen, and the alarm clock icon will disappear.



## Time – Tub Fill

**Path:** [time clock]

**Function:** turns water on from the bath spout for a set period of time at the default temperature.

**Factory default:** 10 minutes



**CAUTION: Risk of property damage.** Water may overflow the bath if the fill timer is set too long. Test the amount of time it takes to fill your bath before using the [tub fill] option for the first time.

**NOTE:** The [tub fill] option is only available on custom shower systems with a bath spout. During system setup in the controller Web pages, the appropriate valve outlet must be assigned a bath spout icon.

### Test Tub Fill

- From the home screen, touch the [shower] icon.
- The shower screen will appear with the default shower outlet highlighted/selected.
- Touch the bath spout icon to select it. Deselect all other outlets.
- Refer to a clock or stopwatch to determine the amount of time it will take for your bath to fill.
- Touch the green [start] icon to begin water flow from the bath spout. Record the start time.
- Allow the bath to fill.
- Once your bath is filled, touch the [stop] icon to turn off the spout. Record the stop time.
- Use the recorded time as the maximum limit when setting the timer for the [tub fill] option.

### Activate Tub Fill

- Touch the time clock on any screen.

**NOTE:** The clock is located above the home screen icons, or at the right top corner of all other screens.

- A pop-up window will appear showing the current time and three time-related options.
- Touch the [tub fill] option.



## Time – Tub Fill (cont.)

- To adjust the time duration, touch the up or down arrows. Minutes adjust sequentially. Seconds adjust in 15-second increments.
- Touch [start] to begin water flow from the bath spout.
- **If water was running from other fixtures:** when [tub fill] is activated, the system shuts the other outlets off. Water will flow only from the bath spout at the designated default temperature.
- **If water was not running from other fixtures:** when [tub fill] is activated, water flows from the bath spout, rising to the designated default temperature.
- While [tub fill] is activated, a countdown clock appears in place of the time clock on all screens.
- When the specified time period has elapsed, the pop-up window appears with the countdown clock at zero, and the interface will beep every 10 seconds.
- The beeps cease after 2 minutes, or when the user touches [ok], [x], or the power icon.

## Cancel Tub Fill

- To stop water flow from the bath spout before the fill time as elapsed, touch [stop].
- Water flow will cease, and the pop-up window will disappear, returning the interface to the previous screen.

## User Interface Software

The user interface includes several open source packages under different open source licenses as listed below. Source codes for the GPL and LGPL packages are available directly from Kohler Company. Contact Kohler Co. at 1-800-4KOHLER for more information or to obtain a copy.

- Linux kernel, cross\_scripts, cramfs, fakeroot, intltool, mtd-utils, pkgconfig, uboot, busybox, e2fsprogs, lzo, tslib, util-linux, dtc, freetype are licensed under the GPLv2:  
<http://www.gnu.org/licenses/gpl-2.0.html>
- binutils, gcc, gdb, ccache, gdbserver, freetype are licensed under the GPLv3  
<https://www.gnu.org/licenses/gpl-3.0.html>
- glibc and glib2 are licensed under the LGPLv2.1: <http://www.gnu.org/licenses/lgpl-2.1.html>
- gmp is licensed under the LGPLv3.0: <https://www.gnu.org/licenses/lgpl-3.0.html>
- openssh is licensed under <http://cvsweb.openbsd.org/cgi-bin/cvsweb/~checkout~/src/usr.bin/ssh/LICENSE?rev=1.19&content-type=text/plain>
- zlib is licensed under the zlib license: [http://zlib.net/zlib\\_license.html](http://zlib.net/zlib_license.html)
- pcre is licensed under <http://www.pcre.org/licence.txt>
- libffi is licensed under <https://raw.githubusercontent.com/atgreen/libffi/master/LICENSE>
- Dhcp, expat, freetype are licensed under the BSD license:  
<https://www.freebsd.org/copyright/freebsd-license.html>
- openssl is licensed under the OpenSSL license: <http://www.openssl.org/source/license.html>
- Fontconfig, ncurses, libxml2 are licensed under the MIT license:  
<http://www.opensource.org/licenses/mit-license.html>

## Open Source Packages Used

S. No.	Package Name	Version	License
1	Linux kernel	3.14	GPLv2
2	binutils	2.24	GPLv3
3	gcc	4.8.4	GPLv3

## User Interface Software (cont.)

S. No.	Package Name	Version	License
4	glibc	2.18	LGPL
5	gdb	7.7	GPLv3
6	cross_scripts	NA	GPLv2
7	cramfs	1.1	GPLv2
8	fakeroot	1.14.4	GPLv2
9	intltool	0.50.2	GPLv2
10	mtd-utils	1.5.0	GPLv2
11	pkgconfig	0.28	GPLv2
12	ccache	3.1.9	GPLv2
13	dtc	1.4.1	GPL
14	uboot	2014.07	GPLv2
15	busybox	1.23.1	GPLv3
16	fontconfig	2.11.1	MIT
17	dhcp	3.1-ESV-R3	BSD
18	e2fsprogs	1.42.8	GPLv2
19	gdbserver	7.7	GPLv3
20	lzo	2.06	GPLv2
21	tslib	1	GPLv2
22	util-linux	2.21.2	GPLv2
23	zlib	1.2.8	BSD
24	expat	2.1.0	BSD
25	freemfont-ttf	20100919	GPLv3
26	freetype	2.4.10	BSD/GPL dual license
27	glib2	2.41.2	LGPL
28	gmp	6.0.0	LGPLv3
29	libffi	3.0.13	BSD
30	ncurses	5.9	MIT
31	pcre	8.31	BSD
32	openssh	6.7p1	BSD
33	libxml2	2.8.0	MIT
34	openssl	1.0.1k	OpenSSL

## Compliance

### FCC Interference Statement

This device complies with Part 15 of the FCC Rules. Operation is subject to the following two conditions:

1. This device may not cause harmful interference, and
2. This device must accept any interference received, including interference that may cause undesired operation.

Changes or modifications not expressly approved by the party responsible for compliance could void the user's authority to operate the equipment.

This equipment has been tested and found to comply with the limits for a Class B digital device, pursuant to Part 15 of the FCC Rules. These limits are designed to provide reasonable protection against harmful interference in a residential installation. This equipment generates, uses, and can radiate radio frequency energy and, if not installed and used in accordance with the instructions, may cause harmful interference to radio communications. However, there is no guarantee that interference will not occur in a particular

### **Compliance (cont.)**

installation. If this equipment does cause harmful interference to radio or television reception, which can be determined by turning the equipment off and on, the user is encouraged to try to correct the interference by one or more of the following measures:

- Reorient or relocate the receiving antenna.
- Increase the separation between the equipment and receiver.
- Connect the equipment into an outlet on a circuit different from that to which the receiver is connected.
- Consult the dealer or an experienced radio/TV technician for help.

### **Industry Canada Statement**

This device complies with Industry Canada licence-exempt RSS standard(s). Operation is subject to the following two conditions:

1. This device may not cause interference, and
2. This device must accept any interference, including interference that may cause undesired operation of the device.

CAN ICES-3(B)/NMB-3(B)

USA/Canada: 1-800-4KOHLER

México: 001-800-456-4537

[kohler.com](http://kohler.com)

THE BOLD LOOK  
OF **KOHLER**®

©2020 Kohler Co.

1241234-5-D