

### 97904T Floormount Bath Shower Faucet-Mounting Base

#### BEFORE YOU BEGIN

All information is based on the latest product information available at the time of publication. Kohler Co. reserves the right to make changes in product characteristics, packaging, or availability at any time without notice.

Please leave these instructions for the consumer. They contain important information.

#### NOTES:

1. Flush the water supply pipes thoroughly to remove debris.
2. Inspect the supply tubing for damage. Replace as necessary.
3. Observe local plumbing codes.
4. Check for leaks before covering the pipes, repairs as needed.

#### ROUGH-IN DIMENSIONS

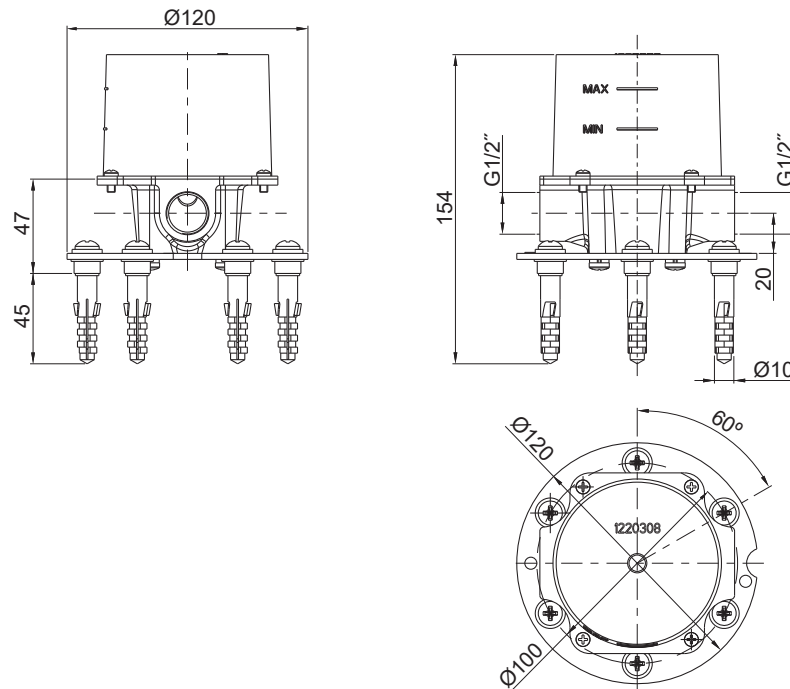

#### INSTALLATION

Determine a suitable location according to tub. Make the blue mark on the mounting base(1) facing to cold water and the base being in the convenient position to connect cold pipe and hot pipe. Mark mounting base hole locations on the floor according to the faucet determined location and base mounting dimensions. **NOTE:** Determine the mounting position of the base according to dimensions of the selected faucet, make sure to keep a suitable distance between mounting base and the finished wall.

Drill holes on the floor with  $\text{Ø}10$  spade drill bit. Press the anchors(2) into the holes. Screw the self-tapping screws(3) with the washers(4) into the anchors through the mounting base. Use a level to ensure that mounting base is horizontal. Tighten self-tapping screws to secure the mounting base.

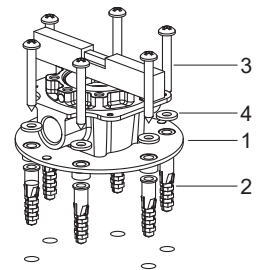

①

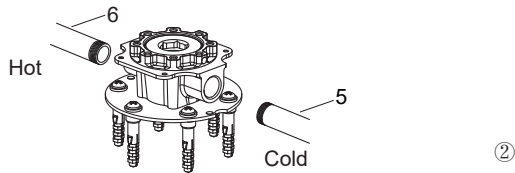

Supply enough tape or sealant on pipe threads. Connect G1/2" cold and hot water supply pipes(5, 6) to base. **NOTE:** The end with blue mark is connected to cold water. If the base level is broken by fixing pipes, readjustment is needed.

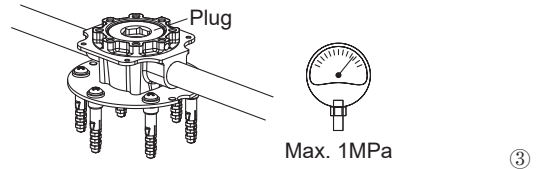

Increase hot and cold water supply pressures to 1MPa. Inspect for leaks. **NOTE:** If the plug is removed, please do not over tighten when putting it back, otherwise it may damage the product.

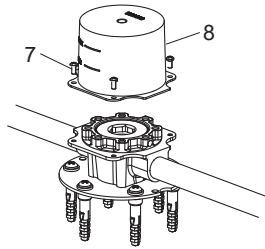

Secure protector(8) onto the base with screws(7).

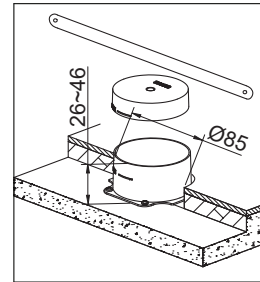

Make sure the distance between bottom of protector and top surface of tiles is within 26~46mm(top surface of tiles is between the MIN and MAX line on the protector). Drill Ø85 hole on the tile. Lay the floor tiles. Cut away the extending part of protector in accordance with the tile surface before install the faucet. The faucet's installation refer to the corresponding installation instructions.

## CLEANING INSTRUCTIONS

All Finishes: Clean the finish with mild soap and warm water. Wipe entire surface completely dry with clean soft cloth. Many cleaners may contain chemicals, such as ammonia, chlorine, toilet cleaner etc. which could adversely affect the finish and are not recommended for cleaning.

Do not use abrasive cleaners or solvents on Kohler faucets and fittings.

## SERVICE PARTS

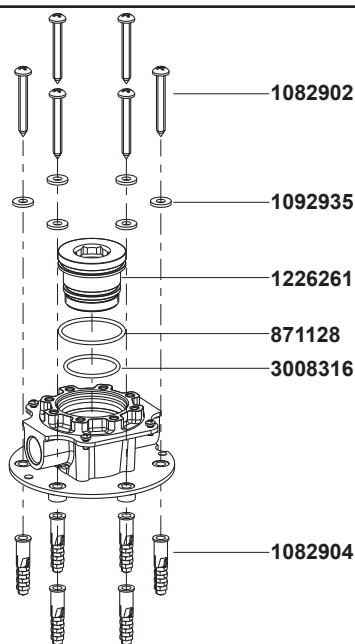

\*\*Color code must be specified when ordering