

Outline
外形轮廓

KOHLER®

K-12629T-1 艾思格尔 ESCALE

修边式台上盆
SELF-RIMMING LAVATORY
切割图/安装说明书
CUT-OUT TEMPLATE / INSTALLATION INSTRUCTIONS

安装之前

- 留意当地所有给排水及建筑规定。
- 检查污水管及供水管，如有需要请更换。
- 安装之前，先开启新脸盆的包装，并小心检查新的脸盆是否有损坏，再将脸盆放回包装盒内，到安装时才取出。
- 若为更换新脸盆，须确保现有的柜台孔口与新脸盆的切割位相同或较后者小。
- 请使用同时印在此说明书上的切割图，标划正确之切割位。
- 科勒脸盆是根据美国标准制造的，与美式洗脸盆配件相配。其它洗脸盆配件可能与之不相配。

所需工具及物料 (不随货供应)

- 模板(已提供)
- 护眼镜
- 炭笔
- 剪刀
- 卷尺
- 涂油灰刀
- 水管用油灰
- 钢锯
- 匙孔线锯或手电锯
- 钻(直径为13mm钻头或更大)
- 活动扳钳
- 喉管扳钳
- 切管刀

尺寸图

Reference Value
参考值

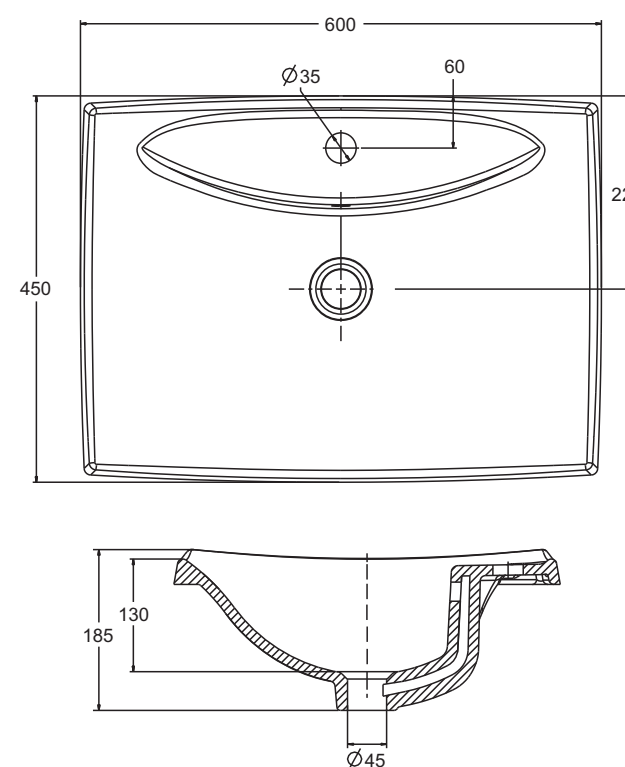

Unit: mm
单位: 毫米

BEFORE YOU BEGIN

- Observe all local plumbing and building codes.
- Inspect the waste and supply tubing; replace if necessary.
- Prior to installation, unpack the new lavatory and carefully inspect it for damage. Return the lavatory to its protective carton until you are ready to install it.
- For replacement installations, make sure the existing cutout is the same or smaller size as the new lavatory.
- Use the template supplied with the lavatory to mark correct size cutout.
- Kohler lavatory is made according to American National Standard that it can match the American lavatory fittings. Any other lavatory fittings may not fit for Kohler lavatory.

TOOLS AND MATERIALS (Not Supplied)

- Template(supplied)
- Safety glasses
- Pencil
- Scissors
- Putty knife
- Plumbers putty
- Hacksaw
- Keyhole saw or saber saw
- Drill (13mm or 1/2" dia. drill bit or larger)
- Adjustable wrench
- Pipe wrench
- Tubing cutter

ROUGHING-IN

拆除旧脸盆

- 关掉水龙头的供水源。
- 打开龙头阀门，然后断开供水管。
- 再旋开排水装置，并拿开弯管。
- 移走旧脸盆。

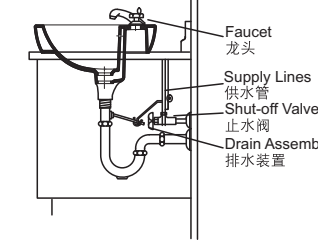

安装新脸盆

- 将切割图沿切割线切出。
- 将切割图放在盥洗台上，确保脸盆、水龙头和防溅挡板之间有足够的距离。
- 查核盥洗台下的储物柜也有足够空间。

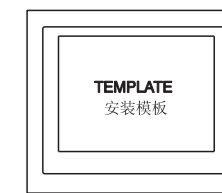

- 用炭笔沿切割图在盥洗台面划线。
- 再次检查脸盆、水龙头、防溅水板及储物柜的空间及距离。如有需要可调整切割图的位置。

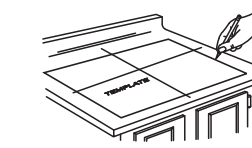

- 用一个13mm的钻头，在切割口内侧钻一个导孔。
- 沿着自切割图勾划出来的铅笔线内侧切开台面。

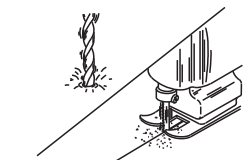

- 暂将脸盆放入台面开口，校正位置。

- 小心：提防身体受伤或产品损坏。请小心处理，或处理不当，将造成产品破损、碎裂或导致身体伤害。可找人一起搬动及安放。

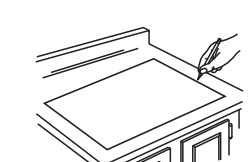

- 用炭笔沿脸盆外缘在盥洗台上划线。
- 然后将脸盆移开。
- 按照制造商的指引，安装水龙头和排水管道。
- 沿炭笔导线内侧涂两滴密封胶。
- 用涂油灰刀将其抹匀。

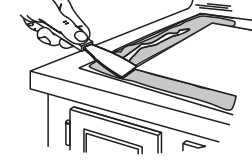

- 小心地将脸盆置于台面切口适当位置，向下按牢。

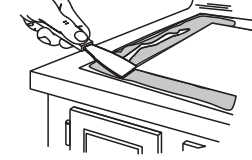

REMOVE EXISTING LAVATORY

- Turn off the water supply to the faucet.
- Open the faucet valves, then disconnect the supply lines.
- Disconnect the drain assembly and remove the trap.
- Remove the existing lavatory.

INSTALL NEW LAVATORY

- Cut the template on the cutout line.
- Position the template on the countertop to ensure clearance between the lavatory, faucet, and backsplash.
- Verify cabinet clearance beneath the countertop.

- Trace the template on the countertop with a pencil.
- Re-check the clearance between the lavatory, faucet, backsplash, and cabinet. Adjust the template accordingly.

- Drill a 13mm hole on the inside of the cutout opening.
- Cut the opening in the countertop along the inside edge of the pencil line.

- Temporarily position the lavatory in the opening, and adjust to fit.
- CAUTION: Risk of personal injury or product damage. Handle with care. Product can break, chip or cause injury if handled carelessly. Get help lifting the lavatory.

- Trace a pencil line around the outside edge of the lavatory.
- Remove the lavatory.
- Install the faucet and drain according to the manufacturers instructions.
- Apply two beads of sealant to the inside of the pencil line.
- Spread the sealant evenly with a putty knife.

- Carefully position the lavatory in the cutout, and press down firmly.

- 小心：提防身体受伤或损坏产品。因大型脸盆相当重，需找人帮您一起搬动及安放。

- CAUTION: Risk of personal injury or product damage. Large lavatories are very heavy. Get help lifting the lavatory into place.

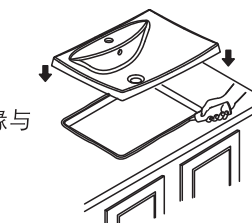

- 立即擦去多余的密封胶。如脸盆外缘与台面间有缝隙，即用胶填满。
- 检查脸盆的位置准确。
- 最少待三十分钟，让封边胶干透后，方可继续进行安装。
- 联接水龙头供水管。
- 联接排水装置。
- 开启水龙头阀门，检查有否渗漏。
- 用非腐蚀性清洁剂来清洁。

- Immediately wipe away any excess sealant, and fill any voids as needed.
- Verify that the lavatory has not moved out of position.
- Allow the sealant to cure for at least 30 minutes before proceeding.
- Connect the faucet supply lines.
- Connect the drain assembly.
- Open the faucet valves, and check for leakage.
- Clean up with a non-abrasive cleaner.

用户须知 (护理和清洁)

为保持脸盆光洁如新，须确保每次使用后彻底冲洗干净。切勿使用腐蚀性的清洁剂，以免刮花及破坏脸盆的表面。要清除顽固污垢，油漆或柏油，可使用松油或油漆稀释剂。

IMPORTANT CONSUMER INFORMATION (CARE AND CLEANING)

To keep your lavatory looking new, make sure you rinse it out thoroughly after each use. DO NOT USE ABRASIVES on this product, as they will scratch and ruin the surface. Stubborn stains, paint, or tar can be removed with turpentine or paint thinner.

维修零件

SERVICE PARTS



1133435-T01-A

广东省佛山市三水区乐平镇
三水中心工业园区科勒大道 邮编: 528137

© 版权为科勒中国有限公司所有, 2009
© Copyright Kohler China Ltd., 2009

沿此线切割
CUT ALONG THIS LINE

科勒公司保留随时变更图中标示尺寸的权利，无需另行通知。
Kohler reserves the right to change marked dimensions without prior notice.

540 mm

400 mm