

73158T-B4 单把脸盆龙头

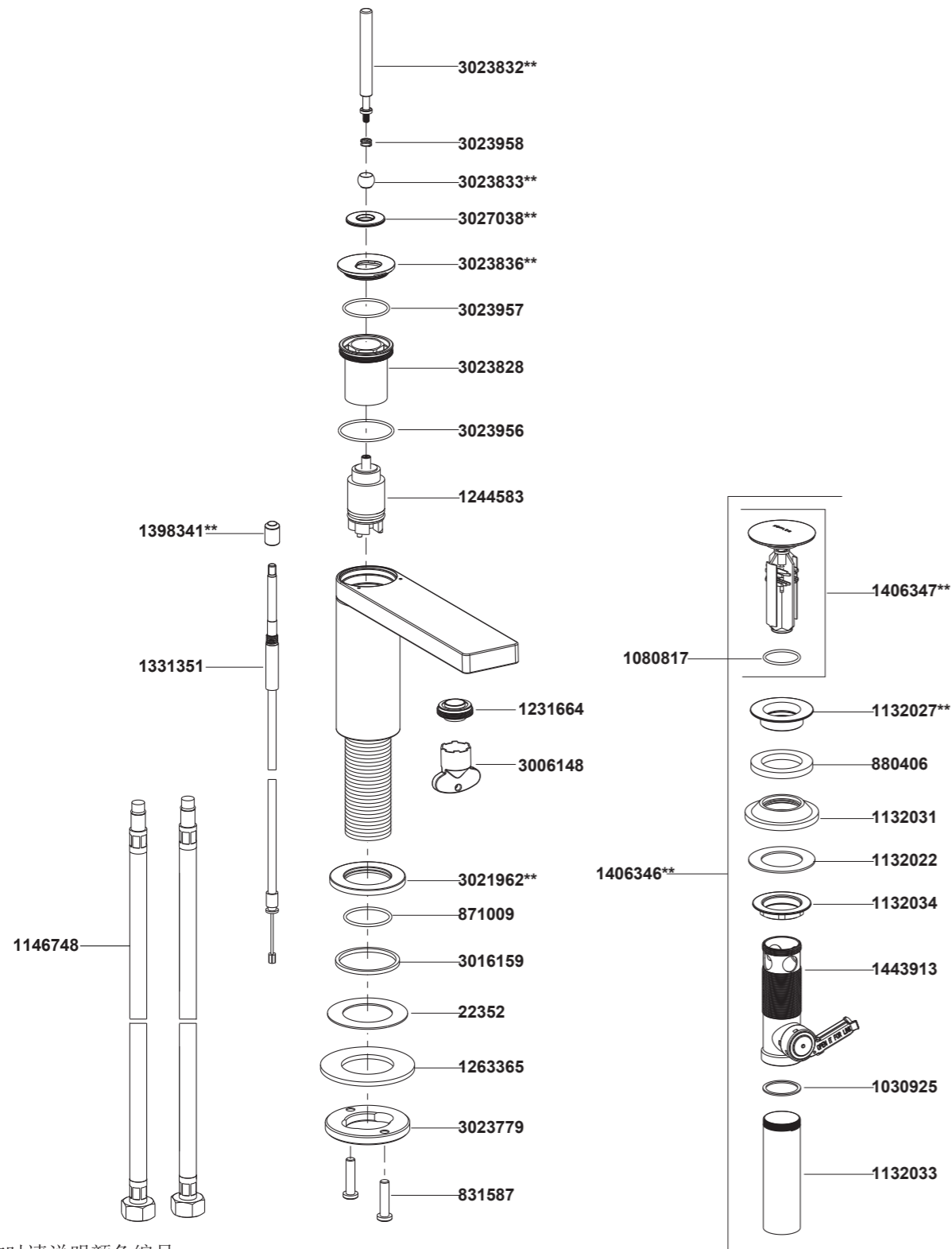

**订购时请说明颜色编号
**Color code must be specified when ordering

73158T-B4 单把脸盆龙头

安装之前

所有的资料是按最新出版的产品资料编写而成。科勒公司保留任何时候不经通知即可改变产品特性、包装或产品可供类型的权利。

说明书包括重要的安装、保养及清洁方面的内容，请把这些资料交给用户阅读。

注意事项：

1. 一定要先彻底冲洗供水管以清除管道中的杂质。
2. 尽可能在安装脸盆之前安装水龙头。
3. 检查供水管有无损坏和漏水。如需要，进行替换和维修。
4. 遵守当地管路安装条例。
5. 切断供水管路。

使用说明

轻轻前拉把手，顺时针旋转为热水，逆时针旋转为冷水。

安装尺寸

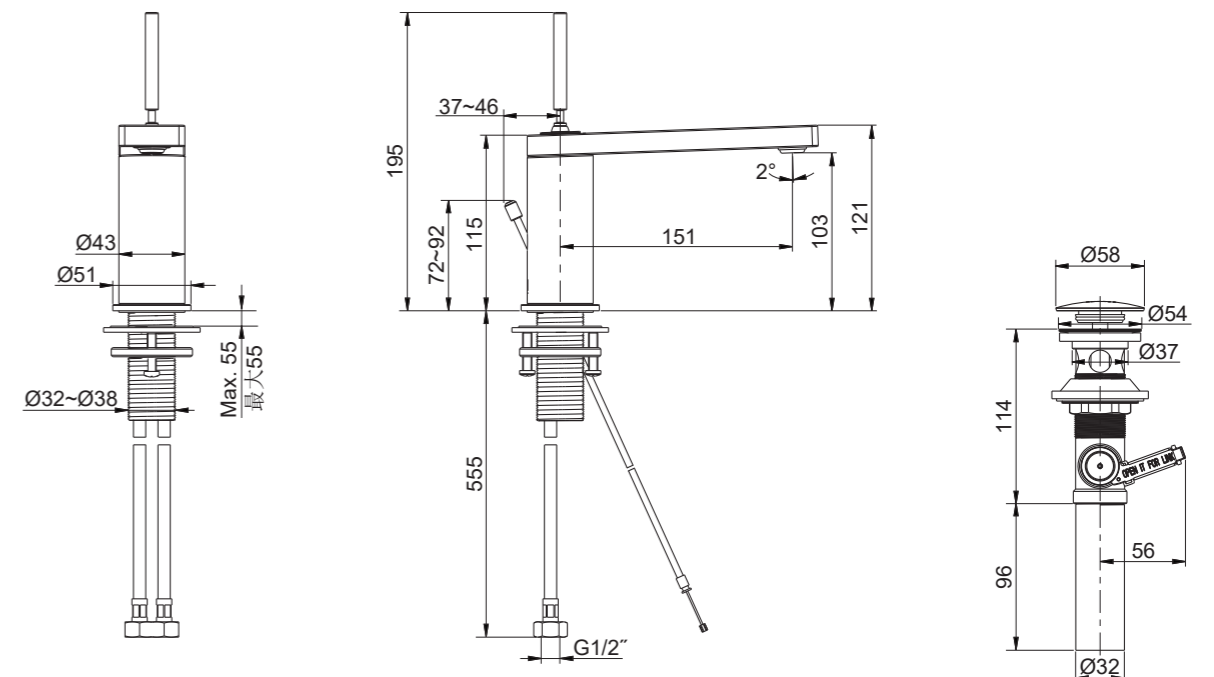

BEFORE YOU BEGIN

All information is based on the latest product information available at the time of publication. Kohler Co. reserves the right to make changes in product characteristics, packaging, or availability at any time without notice.

Please leave these instructions for the consumer. They contain important information.

NOTES:

1. Flush water supply pipes thoroughly to remove debris.
2. If possible, install faucet before installing lavatory.
3. Inspect the supply tubing for damage and leakage. Replace and maintain as necessary.
4. Observe local plumbing codes.
5. Shut off the water supplies to the fitting.

HANDLE OPERATION

Pull the handle gently. Turn clockwise for hot water, counter-clockwise for cold water.

ROUGH-IN DIMENSIONS

安装步骤

INSTALLATION

如何安装出水口

若因维修或其它原因拆下软管(1)，装回时手动拧紧即可。

把垫圈(2)嵌入装饰罩(3)底部槽中，把装饰罩和垫圈套进供水软管、提拉线缆(4)和牙管(5)。

将水龙头组件插入脸盆安装孔中，使装饰罩底部接触台面。

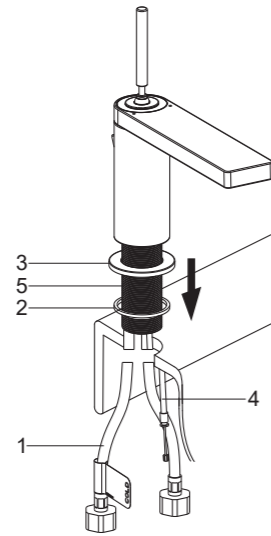

How to Install the Faucet

If need to take off the hoses(1) to repair, reinstall and tighten them by hand.

Install the washer(2) into the groove at the bottom of the escutcheon(3). Slide the escutcheon and washer over the hoses, cable(4) and shank(5).

Insert the faucet assembly into the lavatory hole until the escutcheon bottom is against the deck.

调整水龙头使出水口朝前，将螺钉(6)旋入安装环(7)。

从脸盆下方把垫片(8, 9)套入牙管。旋上安装环以固定水龙头。锁紧螺钉。

把软管接到冷热水源，冷水管贴有“COLD”签。

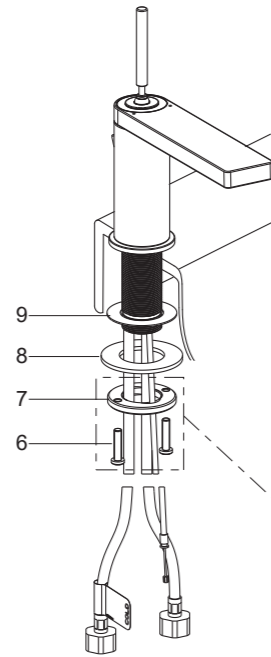

Position the faucet, install the screws(6) into the mounting nut(7).

From underside of the lavatory, place the washers(8, 9) onto the shank. Tighten the mounting nut to secure the faucet. Tighten the screws.

Attach the hoses to water supplies. The hose with "COLD" label should be connected to cold water.

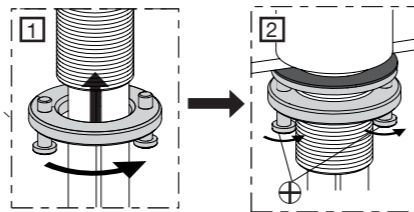

如何安装排水器

将止水塞(10)、法兰盘(11)及垫片(12)从排水本体(14)取下。把排水本体组件从脸盆下方插入排水孔中，调整至合适的位置，再将法兰盘(11)带垫片(12)旋到排水本体上。

用扳手拧紧排水本体上的锁紧螺母(13)。把止水塞(10)放入排水组件。

注意：如果需要，可直接在法兰盘(11)底面沿周围涂一圈密封油灰或其它密封剂，而不使用垫片(12)。

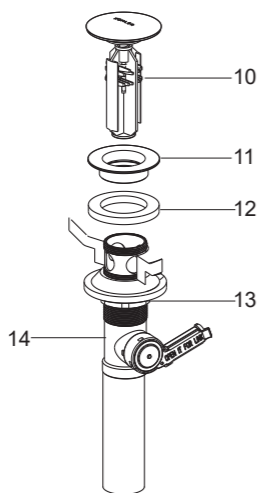

How to Install the Drain

Remove the stopper(10), flange(11) and washer(12) from the drain body(14). Insert the drain body through the drain hole from underside, and adjust the position properly. Screw the flange(11) with washer(12) onto the drain body.

Tighten the locknut(13) on the drain body with wrench. Insert the stopper(10) into the drain assembly.

NOTE: If needed, apply a ring of plumbers putty or other sealants around the underside of the flange(11), instead of using washer(12).

打开排水本体上的盖板(15)，将提拉线缆末端(16)嵌入拉线盒(17)内部的方孔(18)中。使其在拉线盒两端(A, B)卡到位，如图所示。

然后用手扣紧盖板(15)。装好后请拉动提拉头(19)，确保其正常工作。

注意：在锁紧螺母拧紧后，如法兰盘使用密封油灰或其它密封剂，则不可以调整排水本体位置，否则会破坏油灰密封的密封性。同时去除多余油灰。

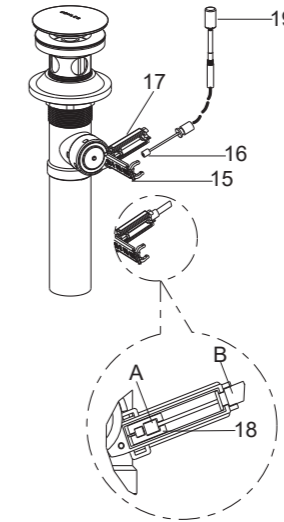

Open the coverplate(15) on the drain body, and insert cable end(16) into the square hole(18) of the cable box(17). Make sure the cable is properly buckled at both ends(A, B) of the cable box as the figure shown.

Lock the coverplate(15), and verify the lift rod(19) on the faucet is linked correctly with the drain body through the cable.

NOTE: Do not reposition the drain if plumbers putty or other sealants applied after the locknut is tightened, or you may break the putty seal. Wipe away excess plumbers putty.

安装结果检查

INSTALLATION CHECKOUT

检查并确保所有的衔接处都已拧紧。确保把手在关闭位置。

打开排水系统和主要供水源，检查并修理有漏水的接口。

用工具(20)将起泡器(21)拆下，打开龙头冷热水，让水流约一分钟以清除杂质。冲洗起泡器，关闭龙头，重新装回起泡器。

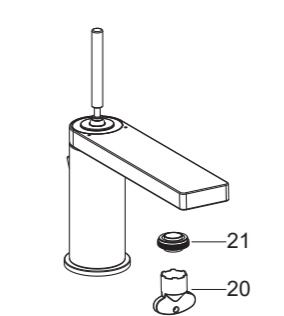

Ensure that all connections are tightened and the handle is in the off position.

Open the drain. Turn on main water supply and check for leaks. Repair as needed.

Remove the aerator(21) with key(20). Turn on the faucet. Run hot and cold water through the spout for about one minute to remove any debris. Remove debris from the aerator. Shut off the faucet and reinstall the aerator.

清洗说明

CLEANING INSTRUCTIONS

适用于所有加工处理过的表面：以中性肥皂水清洗镀层表面，再以干净的软布彻底擦干整个表面，许多清洁剂，比如氨水、去污粉及洁厕灵等，会对电镀表面造成伤害，切忌使用。

有磨损性的清洁用具或清洁剂也不可适用于科勒牌的水龙头及其配件上。

All Finishes: Clean the finish with mild soap and warm water. Wipe entire surface completely dry with clean soft cloth. Many cleaners may contain chemicals, such as ammonia, chlorine, toilet cleaner etc. which could adversely affect the finish and are not recommended for cleaning.

Do not use abrasive cleaners or solvents on Kohler faucets and fittings.