

科 THE BOLD LOOK
勒 OF KOHLER
全 球 厨 卫 经 典

K-14719T-1
思雅 STADIA, WIDE WAIST, WITH FAUCET DECK

时尚脸盆
VESSEL
切割图/安装说明书
CUT-OUT TEMPLATE/
INSTALLATION INSTRUCTION

安装之前

- 留意当地所有给排水及建筑规定。
- 检查污水管及供水管，如有需要请更换。
- 安装之前，先开启新脸盆的包装，并小心检验新的脸盆是否有损坏，再将脸盆放回包装盒内，到安装时才取出。
- 若为更换新脸盆，须确保现有的柜台孔口与新脸盆的切割位相同或较后者小。
- 请使用同时印在此说明书上的切割图，标划正确之切割位。
- 科勒洗脸盆是根据美国标准制造的，与美式洗脸盆配件相配。其它洗脸盆配件可能与之不相配。

所需工具及物料
(不随货供应)

- 模板(已提供)
- 护眼镜
- 铅笔
- 剪刀
- 卷尺
- 涂油灰刀
- 水管用油灰
- 钢锯
- 匙孔线锯或手电锯
- 钻(直径为13mm钻头或更大)
- 活动板钳
- 喉管板钳
- 切管刀

尺寸图

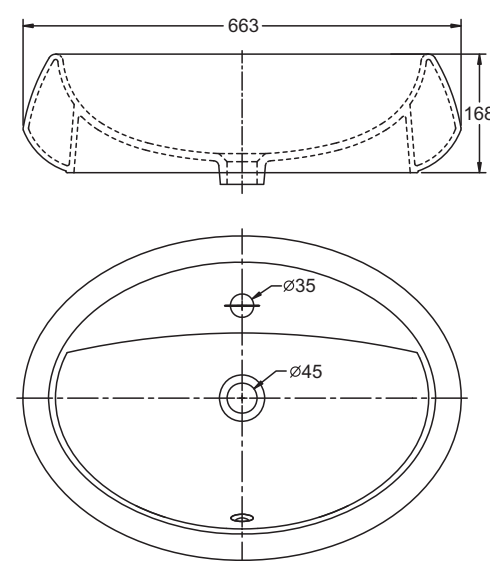

ROUGH-IN

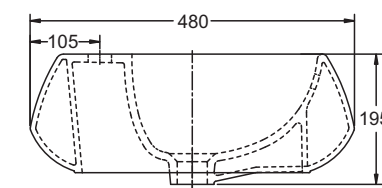

单位: 毫米
Unit: mm

安装新脸盆

- 用剪刀沿切割线将切割图剪出。
- 将切割图放在盥洗台上，定出洗脸盆的安装位置。确保脸盆、龙头和防溅板之间有足够空间。

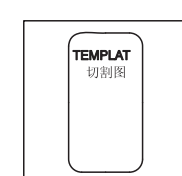

- 用铅笔在台面上沿切割线画出切割轮廓。

RIM OF LAVATORY
脸盆边缘

INSTALL NEW LAVATORY

- Cut the template on the cutout line with scissors.
- Position the template on the countertop to determine lavatory installation position. Make sure enough space between the lavatory, faucet and backsplash.

- Trace the template with a pencil (B) to map the outer rim of the lavatory onto the countertop.

BEFORE YOU BEGIN

- Observe all local plumbing and building codes.
- Inspect the waste and supply tubing, replace if necessary.
- Prior to installation, unpack the new lavatory and carefully inspect it for damage. Return the lavatory to its protective carton until you are ready to install it.
- For replacement installations, make sure the existing cutout is the same or smaller size as the new lavatory.
- Use the template supplied with the lavatory to mark correct size cutout.
- Kohler lavatory is made according to American National Standard that it can match the American lavatory fittings. Any other lavatory fittings may not fit for Kohler lavatory.

TOOLS AND MATERIALS (Not Supplied)

- Template(supplied)
- Safety Glasses
- Pencil
- Scissors
- Tape Measure
- Putty Knife
- Plumbers putty
- Hacksaw
- Keyhole Saw or Saber Saw
- Drill (13mm or 1/2" dia. drill bit or larger)
- Adjustable Wrench
- Pipe wrench
- Tubing Cutter

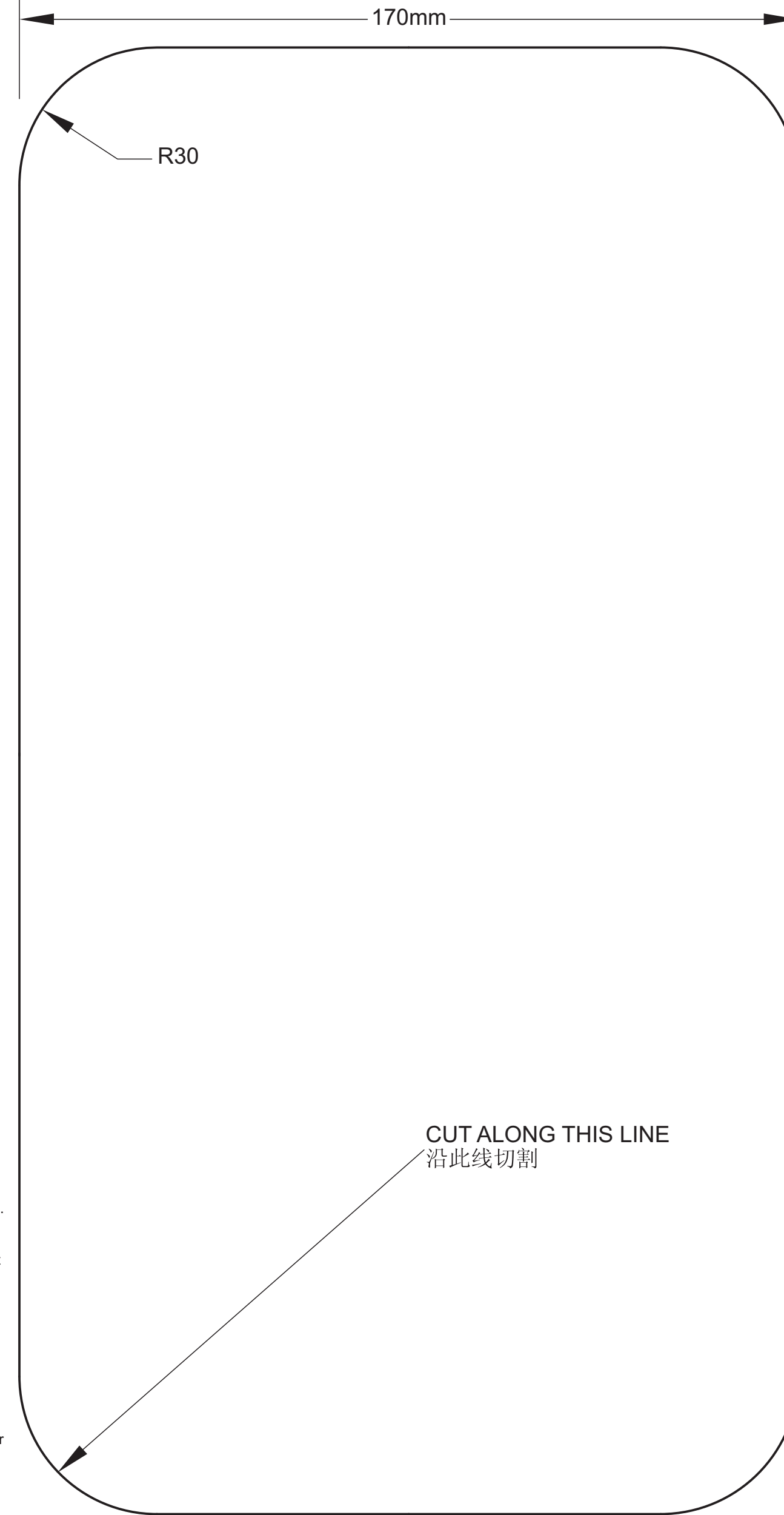

- 用一个13mm的钻头，在切割口内侧钻一个导孔。
- 沿着自切割图勾划出来的铅笔线内侧切开台面。
- 暂将脸盆放入台面开口，校正位置。
- 小心：提防身体受伤或损坏产品。因大型脸盆相当重，需找人帮您一起搬动及安放。
- Drill a \varnothing 13mm hole on the inside of the cutout opening.
- Cut the opening in the countertop along the inside edge of the pencil line.
- Temporarily position the lavatory in the opening, and adjust to fit.
- CAUTION: Risk of personal injury or product damage. Large lavatories are very heavy. Get help lifting the lavatory into place.

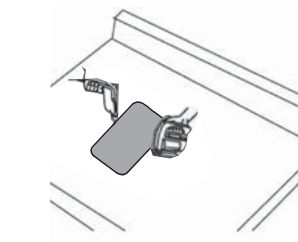

- 将脸盆移开。按照制造商的指引，安装水龙头和排水管道。
- 在脸盆底部涂抹密封胶。
- 小心地将脸盆置于台面切口适当位置，向下按牢。
- 小心：提防身体受伤或损坏产品。因大型脸盆相当重，需找人帮您一起搬动及安放。

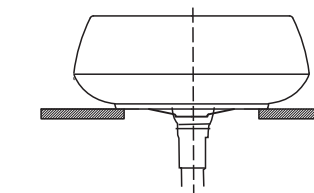

- Remove the lavatory. Install the faucet and drain according to the manufacturers instructions.
- Apply sealant to the bottom installation area.
- Carefully position the lavatory in the cutout, and press down firmly.
- CAUTION: Risk of personal injury or product damage. Large lavatories are very heavy. Get help lifting the lavatory into place.

- 立即擦去多余的密封胶，如脸盆外缘与台面间有缝隙，即用胶填满。
- 检查脸盆的位置准确。
- 最少待三十分钟，让密封胶干透后，方可继续进行安装。
- 联接水龙头供水管。
- 联接排水装置。
- 开启水龙头阀门，检查有否渗漏。
- 用非腐蚀性清洁剂来清洁。
- Immediately wipe away any excess sealant, and fill any voids as needed.
- Verify that the lavatory has not moved out of position.
- Allow the sealant to cure for at least 30 minutes before proceeding.
- Connect the faucet supply lines.
- Connect the drain assembly.
- Open the faucet valves, and check for leakage.
- Clean up with a non-abrasive cleaner.

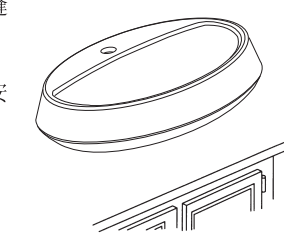

Note 1: Users may change the shape and dimension of the cut-out template as they wish without undermining the strength of the countertop and lavatory installation.

Note 2: It is prohibited to use epoxy resin as the sealant.

Note 3: Faucet needs to be tightly connected with inlet and outlet supplies. Otherwise, it may lead to leakage.

注1: 用户可根据自己的喜好，更改切割图的形状和尺寸，但须保证不影响台面本身的强度和洗脸盆的安装。

注2: 禁止使用环氧树脂胶。

注3: 龙头与进水、排水管件连接要牢固，如连接不牢固，有漏水的可能。

用户须知
(护理和清洁)

为保持脸盆光洁如新，须确保每次使用后彻底冲洗干净，切勿使用腐蚀性的清洁剂，以免刮花及破坏脸盆的表面。要清除顽固污垢，油漆或柏油，可使用松油或油漆稀释剂。

IMPORTANT CONSUMER INFORMATION (CARE AND CLEANING)

To keep your lavatory looking new, make sure you rinse it out thoroughly after each use. DO NOT USE ABRASIVES on this product, as they will scratch and ruin the surface. Stubborn stains, paint, or tar can be removed with turpentine or paint thinner.

1077793-T01-A