

BEFORE YOU BEGIN

开始之前

- Congratulations on your purchase of this high quality Bathroom Accessory. Before proceeding with the installation, please carefully read this installation instruction in order to ensure proper care and assembly of this accessory.
- Please keep this installation instruction for future reference.

- 首先恭喜您购买到了高档的卫浴产品，为了使您正确保护和组装产品，在您安装之前请仔细阅读此说明书。
- 请保留此说明书以备参考。

 Prior to drilling into walls, check there are no hidden electrical wires, cables or water supply pipes with the aid of an electronic detector. If you use power tools do not forget:

1. Wear eye protection.
2. Unplug equipment after use.

 警示：在钻孔之前，请借助电子探测仪确认墙内是否有电源线，通讯光缆或者水管之类的东西。如果使用电钻的话请勿忘记以下两点：

1. 请戴上防护镜。
2. 用完设备后关掉电源。

ROUGHING-IN

尺寸图

UNIT : mm
 单位：毫米

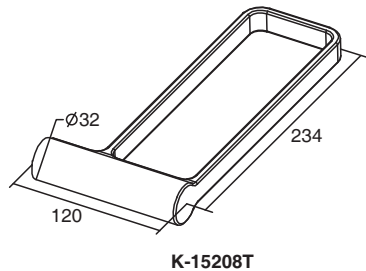
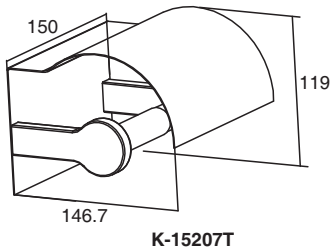
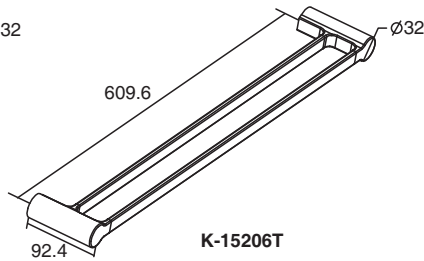
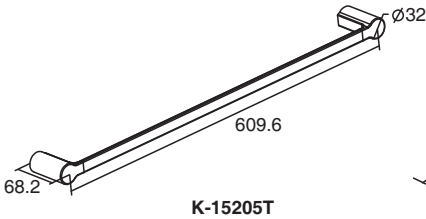

科勒(中国)投资有限公司
 上海市闸北区江场三路158号 邮编：200436

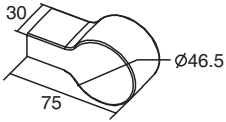

K-15209T

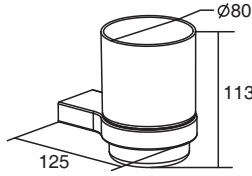

K-15210T

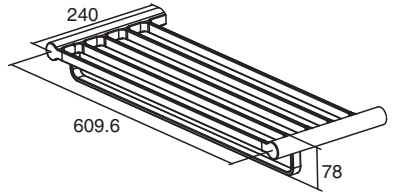

K-15213T

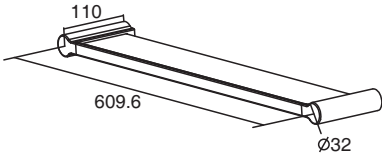

K-15215T

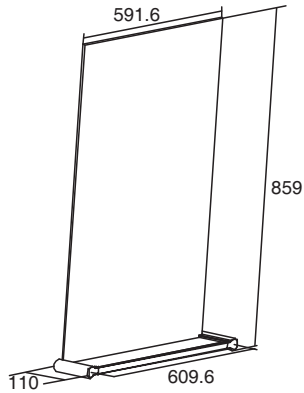

K-15216T

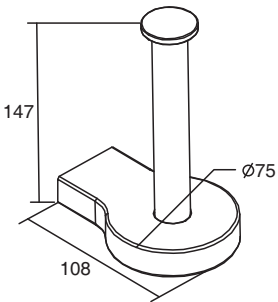

K-15217T

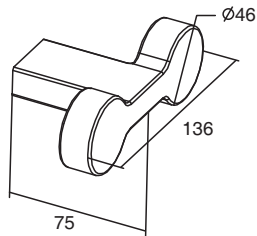

K-15218T

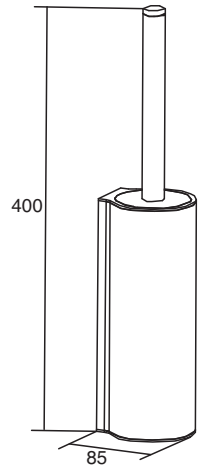

K-15222T

INSTALLATION

安装步骤(非镜子类安装)

1. Put the drilling template to the desired installation position and verify level.
1. 将包装内的钻孔模板放在希望安装配件的位置，并确保水平。

Mark the centerpoints of the multiple-post accessory.
标出多个基座的中心。

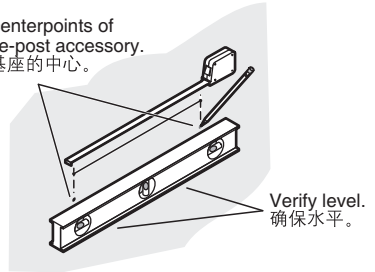

2. According to the drilling template, use a 6mm drill to drill in the wall and insert the wall plugs.
2. 依据钻孔模板，用6毫米的钻头在墙上钻孔，并塞进壁塞。

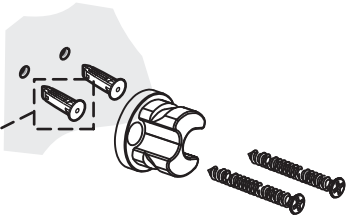
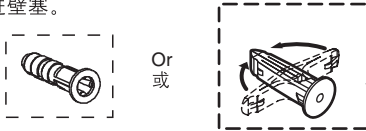

3. Fix the wall plate to the wall with screws.
3. 最后用螺钉将挂墙支架固定在墙上。

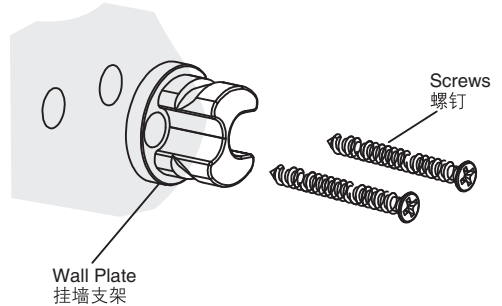

4. Secure the Accessory
4. 固定浴室配件

A Slide accessory post onto wall plate.
A 将浴室配件基座套上挂墙支架。

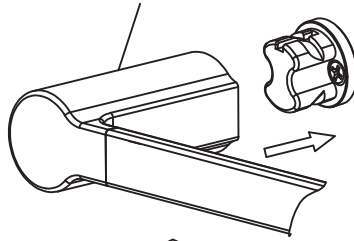

B Secure with setscrew.
B 用固定螺丝将浴室配件锁紧在挂墙支架上。

INSTALL THE MIRROR

镜子的安装

- Put the drilling template to the desired installation position and verify level.
- 将包装内的钻孔模板放在希望安装镜子的位置，调至水平。

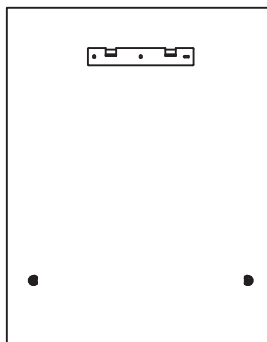

- According to the drilling template, use a 6mm drill to drill in the wall and insert the wall plugs.

- 按照钻孔模板，用6毫米的钻头在墙上钻孔，并塞进壁塞。



Or
或

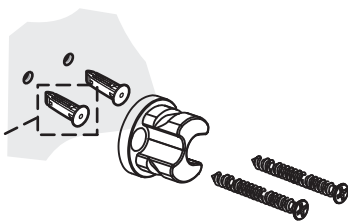
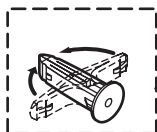

- Fix the wall plate and the mirror plate to the wall with screws.

- 用螺钉将挂墙支架和镜子背板固定在墙上。

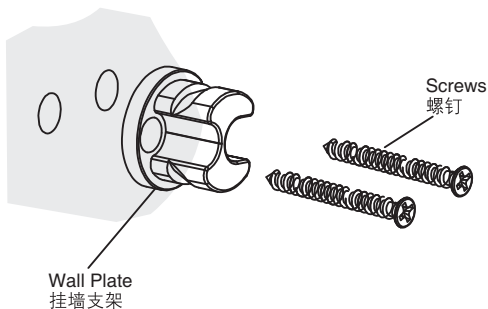
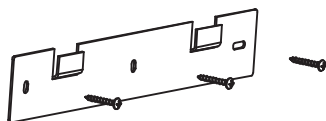

8. Hang the mirror to the mirror plate.

8. 将镜子挂在镜子背板上。

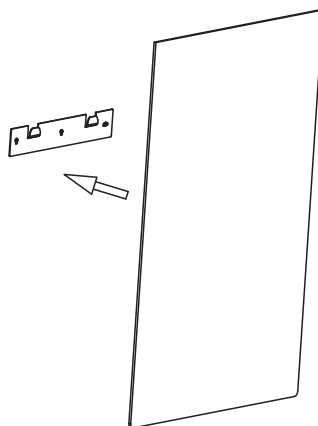

9. Set the mirror base to the wall plate and fix the base to the wall plate with screws securely.

9. 将玻璃平台底座套在挂墙支架上，并用固定螺丝将底座与挂墙支架锁紧。

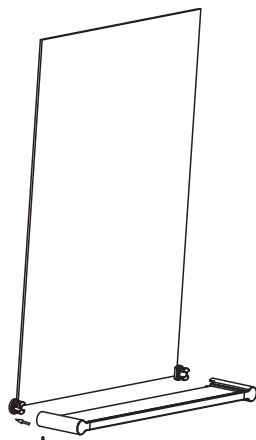

CARING FOR YOUR PRODUCTS

保养须知

The accessories should be washed with warm water and a soft cloth or sponge. Do not use abrasive cleaners or cleaners containing bleach.

为了更好地保养本品，请您用温水和软毛巾(或海绵)擦拭，含有腐蚀性或漂白剂的洗洁剂对本品有害。