

ROUGHING-IN 产品尺寸图 (Unit:mm)(单位:毫米)

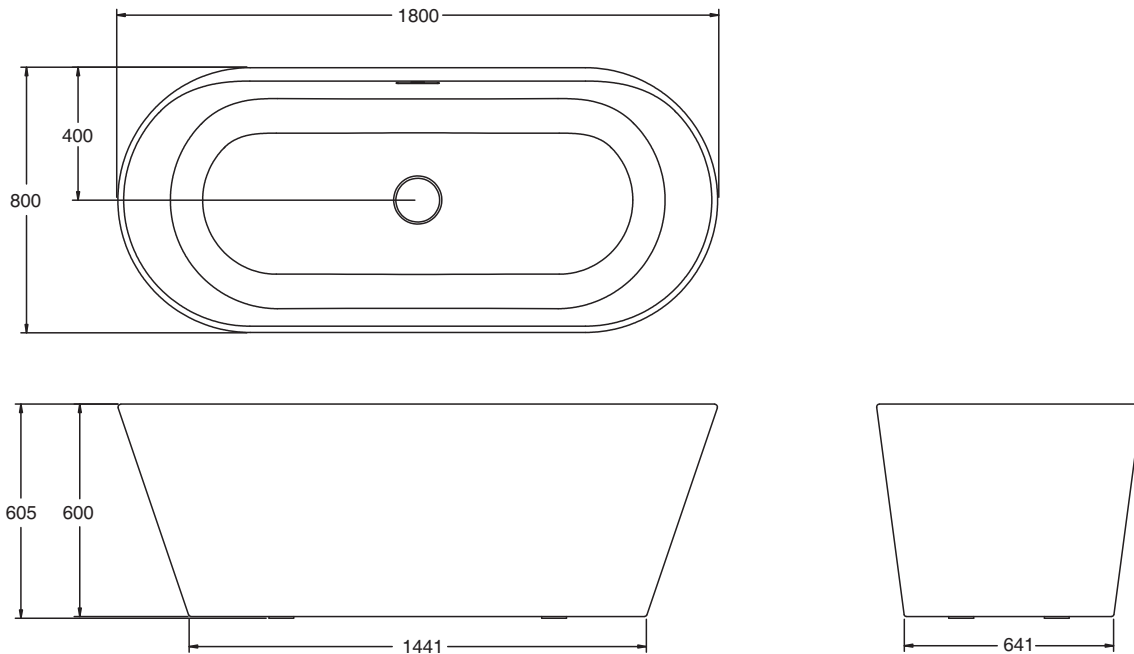

PRODUCT INFORMATION 产品信息

Water Depth 深度 (To Overflow Hole Bottom 至溢水口底部)	420mm (毫米)
Capacity 水容量 (To Overflow Hole Bottom 至溢水口底部)	400L (升)
Basin area 底部面积	1348mm (毫米) × 450mm (毫米)
Top area 顶部面积	1760mm (毫米) × 742mm (毫米)

Installation Notes 安装注意事项

- Install this product according to the installation guide.
请根据说明书安装本款产品。
- LITHOCAST baths are extremely heavy, making some installations difficult.
由于绮美石浴缸非常重, 可能会给安装造成一定困难。
- **NOTE:** Use lifting straps to lift or move the bath.
注意: 在抬起或移动浴缸时推荐使用绑带。
- Unless otherwise specified floor support under bath must provide for a minimum of 650kg loading (including the weight of bathtub, water and one user).
除非另有说明, 否则浴缸下地面必须至少可以承载650kg的负载(包含浴缸、水及一名使用者的重量)。

Accessory Information 配件信息

Drain 落水.....1144009-0

Compiled information is subject to change without prior notice
收录信息如有变动恕不另行通知

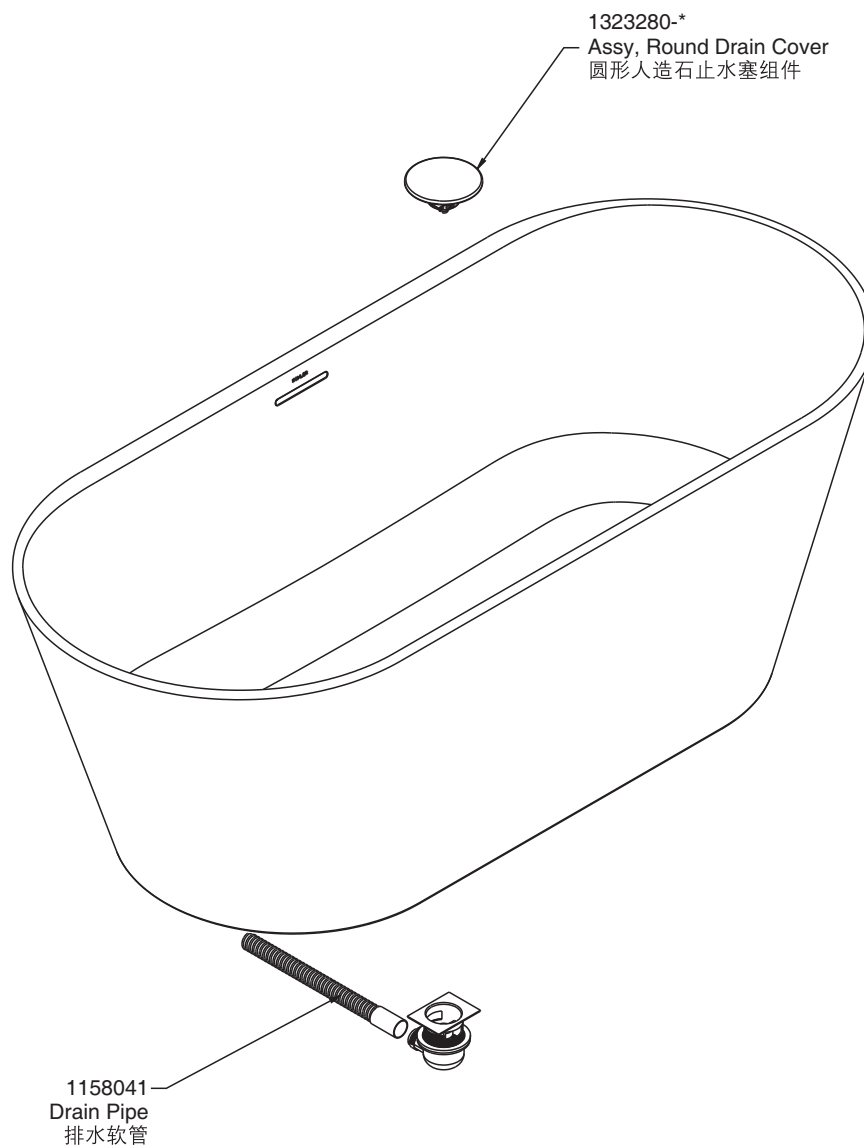

Color code (-*) or finish (-**) must be specified when ordering.
订购时请说明颜色代码(-*)或表面处理(-**)