

NOTE: BEFORE CUTTING COUNTERTOP ALLOW  
FOR HANDLE CLEARANCE.  
注意: 切割台面前, 请预留龙头把手的操作距离。

51mm Min.  
至少为51mm

64mm

☉ OF FITTING  
龙头中心线

319mm

# K-2882T VERTICYL™ 维克



## VITREOUS CHINA RECTANGULAR UNDERCOUNTER LAVATORY 釉面陶瓷长方形台下脸盆 CUT-OUT TEMPLATE / INSTALLATION INSTRUCTIONS 切割图/安装说明书

### BEFORE YOU BEGIN

- Due to the nature of the installation, undercounter lavatories should be installed by trained and experienced installers.
- Do not use adhesives or adhesive sealants between marble countertop and lavatory.
- Inspect the waste and supply tubing; replace if necessary.
- Prior to installation, unpack the new lavatory and inspect it for damage. Return the lavatory its protective carton until you are ready to install it.
- Observe all local plumbing and building codes.
- Kohler lavatory is made according to American National Standard that it can match the American lavatory fittings. Any other lavatory fittings may not fit for Kohler lavatory.
- The product conforms to GB/T 6952-2015, ASME A112.19.2-2013 and CSA B45.1-08. Please choose faucets that accord with these standards. Kohler faucets are recommended.

### 安装之前

- 有关安装属专业性, 故盥洗台下脸盆必须由受过训练及有经验的技师进行安装。
- 切勿在台盆与大理石之间使用胶黏剂或有黏性的密封胶。
- 检查出水及供水管道, 如有需要便更换。
- 安装之前先开启新脸盆的包装, 检查有无损坏后放回纸箱中以免损坏, 到准备安装时才取出。
- 遵守当地所有给排水及建筑规定。
- Kohler lavatory is made according to American National Standard that it can match the American lavatory fittings. 其它洗脸盆配件可能与之不相配。
- 本脸盆符合中国国家标准GB/T 6952-2015及美国/加拿大标准ASME A112.19.2-2013/CSA B45.1-08。请选择符合上述标准的龙头。推荐使用科勒公司龙头。

### TOOLS AND MATERIALS (Not Supplied)

- Sealant
- Pencil
- Tape measure
- Sharp knife or scissors
- Keyhole or saber saw
- Drill (1/2" dia. drill bit or larger)
- Safety glasses
- Hammer
- Rags or paper toweling
- Strong AB sealant

NOTE: You may require different, more specialized tools to install this lavatory to countertop materials other than wood or wood composites.

### 所需工具及物料 (不随货供应)

- 密封胶
- 炭笔
- 卷尺
- 尖刀或剪刀
- 匙孔线锯或手电锯
- 钻(直径1/2英寸或更大的钻头)
- 防护眼镜
- 锤子
- 抹布或抹手纸
- 高强度AB胶

注意: 若盥洗台的物料并非木或木质合成品, 则你可能需要在安装脸盆时使用其他更专门的工具。

### ROUGHING-IN

Reference Value  
参考值

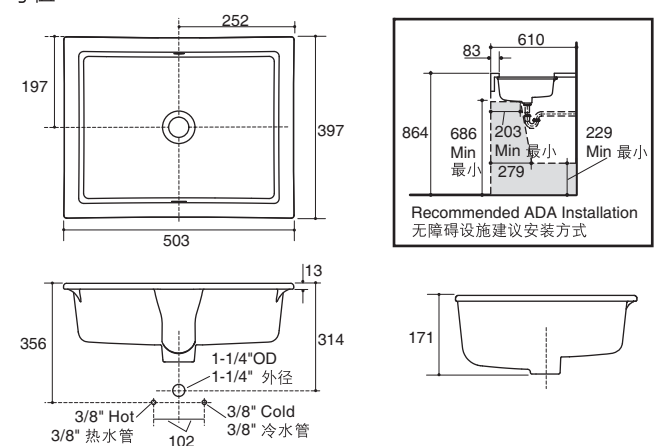

### 尺寸图

Unit:mm  
单位:毫米

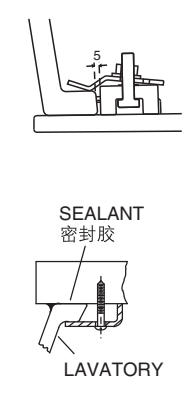

Note: waterproof unprotected overhang area on the underside of wood counter.  
注: 木质盥洗台下露出部份须作防水处理。

Kohler reserves the right to change marked dimensions without prior notice.  
科勒公司保留随时变更图中标示尺寸的权利, 无需另行通知。

### CUT ALONG THIS LINE 沿此线切割

WHEN PLOTTING TEMPLATE FULL SIZE:  
Make sure horizontal and vertical dimensions match the dimensions labeled on the template.  
按实际大小标绘切割图时: 确保横向及纵向尺寸与切割图上所标尺寸相符。

### INSTALL THE LAVATORY

- Check the desired lavatory location for clearance between the backsplash, faucet, fixture, and cabinet.
- Cut out the template.
- Carefully position and trace the template on the countertop as directed on the template.
- Mark the faucet hole centerline on the countertop.
- Drill a 1/2" pilot hole on the inside of the cut line.
- Cut out the countertop opening with a saber or keyhole saw.

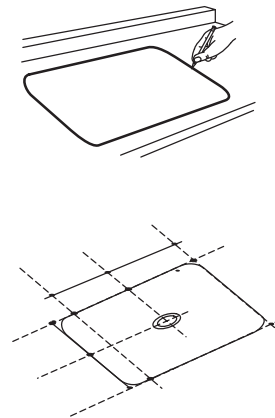

### FOR WOOD COUNTERTOPS

- Mark and pre-drill the wood screw holes at the locations shown on the template.
- Waterproof any exposed areas of wood.

### FOR MARBLE COUNTERTOPS

- Clean the countertop and block. Keep them dry.

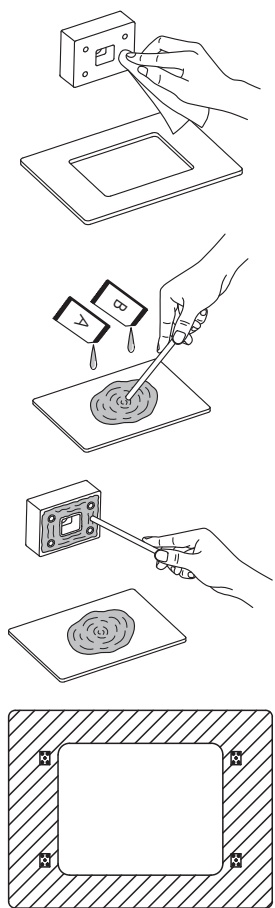

- Take same amount of strong A and B sealant and mix them up.

- Insert the screw into the hole in middle of the block and then apply the mixed sealant onto the block.

- Glue the block to the countertop as shown.

- Fix the block and keep at least 5mm from the edge of the lavatory.

- Place the lavatory after 2 hours. Tighten the screw and apply silicone sealant around the edge of the lavatory.

### 安装脸盆

- 检查准备装上脸盆的位置, 是否与后挡水板、水龙头、脸盆及柜子保持足够的距离。
- 剪出模板。
- 将模板小心放置于盥洗台上, 并在台面上按照模板画出其边缘轮廓导线。
- 在盥洗台上标出水龙头孔位的中心线。
- 在切线内侧钻一个12mm的导孔。
- 用手提电锯或匙孔线锯切开盥洗台。

### 木制盥洗台

- 按照模板所示的位置, 在台面标出及预先钻妥木螺钉的位置。
- 其他外露的木表面需保持防水。

### 大理石盥洗台

- 清洁台面和定位块, 并保持干燥。

- 取高强度A、B胶若干, 按1:1搅匀。

- 将螺丝放入定位块中间的孔内, 并将搅匀的胶水涂抹在定位块上。

- 将定位块按位置与台面粘合。

- 固定定位块, 并与盆边保持5mm以上的距离。

- 2小时后将盆放好, 拧紧螺母, 沿盆边打好硅胶。

- Keep away from heavy objects within 24 hours.

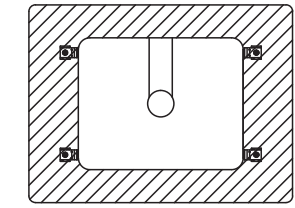

- 24小时内勿承重物。

### FOR ALL INSTALLATIONS

- If the countertop has not been installed, install it at this time.
- Drill the faucet holes according to the faucet installation instructions.
- Install the faucet to the countertop according to the manufacturer's instructions.
- Install the drain to the lavatory according to the manufacturer's instructions.
- NOTE: Please do not use sealant without contractility after drying, such as marble adhesive.
- Apply a continuous bead of quality sealant to the lavatory rim where it will contact the countertop, such as glass cement.



### 所有台面的安装

- 如还未安装盥洗台, 请在这时装上。
- 按照龙头安装说明引钻龙头孔。
- 按照制造商的说明书, 在盥洗台上装上水龙头。
- 按照制造商的说明书, 在脸盆下装上排水管。
- 注意: 请勿在本品上使用干燥后没有收缩性的胶黏剂, 如云石胶等。
- 在与盥洗台接触的脸盆边缘, 如珠串胶涂上优质密封胶, 如玻璃胶等。

- NOTE:
- For marble countertop, use the clamp assembly supplied.
- For countertop made of wood or wood compound (over 25mm thick), purchase clamp assembly 52047.
- For countertop of other materials, use proper clamp assembly by referring to the suggestions on the installation instructions of the countertop manufacturer.

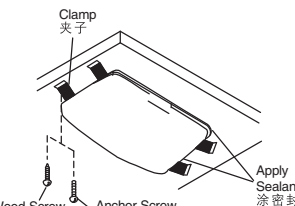

- 注意:
- 大理石材质的盥洗台, 使用随附的夹子组件。
- 木、木质合成物的盥洗台(厚度25毫米以上), 可另行购买夹子组件52047。
- 其它材料制造的盥洗台, 则请参考盥洗台制造商说明书上的建议, 使用适当的扣件。

- Position the lavatory squarely under the cutout before tightening the clamps. Draw the lavatory rim up to the countertop until it is snug. Do not overtighten.
- Immediately wipe away any excess sealant.
- Make the final drain and faucet connection to complete the lavatory installation. Be sure to follow all instructions packed with the drain and faucet.
- Clean up with a non-abrasive cleaner.

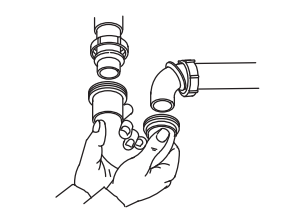

- 在上紧夹具前, 先将脸盆平整地放在盥洗台切口下, 然后小心将脸盆拉直直至台面才可上夹具, 切勿上得太紧。
- 立即擦去多余的密封胶。
- 最后将所有水管及水龙头与脸盆连接妥当, 确保安装乃符合水管及水龙头的一切有关的安装说明书。
- 使用非腐蚀性的清洁剂进行清洁。

### CARE AND CLEANING

To keep your lavatory looking new, make sure you rinse it out thoroughly after each use. DO NOT USE ABRASIVES on this product, as they will scratch and ruin the surface. Stubborn stains, paint, or tar can be removed with turpentine or paint thinner.

### 护理和清洁

为保持脸盆光洁如新, 须确保每次使用后彻底冲洗干净, 切勿使用腐蚀性的清洁剂, 以免刮花及破坏脸盆的表面。要清除顽固污垢, 油漆或柏油, 可使用松油或油漆稀释剂。

Do not use the product in the water below 0°C.  
CAUTION: Please do not use hard materials (like scouring pad) to clean product surface, especially the product logo.

不要在0°C以下的水环境中使用。  
警告: 请勿使用钢丝球等硬质材料擦洗产品表面, 特别是产品商标处。

### SERVICE PARTS

### 维修零件

1321585  
Clamp Accessory Pack  
夹子组件  
(For Marble Countertop Only)  
(仅适用于大理石台面)

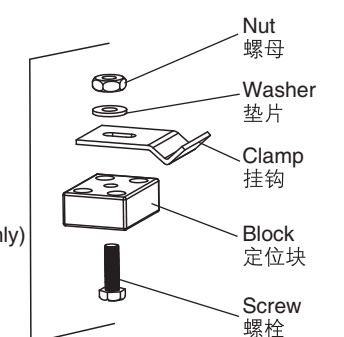

NOTE: Please purchase clamp accessory pack 52047 for wooden countertop.  
注意: 如为木质台面, 请另行购买夹子组件52047。

BLOCK  
定位块

CLIP LOCATIONS  
夹子位置

### IMPORTANT:

For wooden countertop, basin clamp assembly 52047 purchased can only be used on countertops with a minimum thickness of 1". Installer must supply anchors for thinner countertops.

重要:  
对于木质台面, 另购的52047夹子组件仅可用于厚度最少为25mm的台面, 如果台面较薄, 请另外使用膨胀螺栓固定。

RIM OF LAVATORY  
脸盆边缘

432mm