

## BEFORE YOU BEGIN

- Please read these instructions carefully to familiarize yourself with the required tools, materials, and installation sequences. Follow the sections that pertain to your particular installation. This will help you avoid costly mistakes. In addition to proper installation, read all operating and safety instructions.
- All information in these instructions is based upon the latest product information available at the time of publication. Kohler China reserves the right to make changes in product characteristics, packaging, or availability at any time without notice.
- These instructions contain important care, cleaning, and warranty information - **please leave instructions for the consumer.**
- Fixture dimensions are nominal and conform to tolerances established by ASME Standards (A112.19.2-2018).
- The product complies with GB 6952-2015, GB 28377-2019.

## 安装之前

- 请小心详阅本指引。以便熟悉所需工具、材料及安装程序。请遵照适用的章节来安装你的小便器，以避免由于安装不当而导致不必要的损失。除了有关正确的安装方法之外，还务请详阅所有操作及安全指引。
- 本指引所载之一切资料，均以印刷时所有之最新产品情况为基础，科勒中国保留权利随时更改产品特性、包装或供应情况，恕不另行通知。
- 本指引也包含了有关护理、清洁及保养等重要资料 - 请交予用户保存。
- 部件尺寸为标定值，误差符合美国ASME标准A112.19.2-2018。
- 本产品符合GB 6952-2015、GB 28377-2019。

## ORDERING INFORMATION

BARDON WH Urinal (Top) (1L/2.5L).....K-4960T-2ET  
 BARDON WH Urinal (Rear) (1L/2.5L).....K-4960T-2ER

## 订购资料

巴尔顿节水型小便器(上进水) (1L/2.5L) .....K-4960T-2ET  
 巴尔顿节水型小便器(后进水) (1L/2.5L) .....K-4960T-2ER

## ROUGHING-IN

\* Recommended dimensions for installation only, please adjust according to actual situation.

\* 仅为建议安装尺寸，客户可根据实际情况调整。

Reference Value  
 参考值

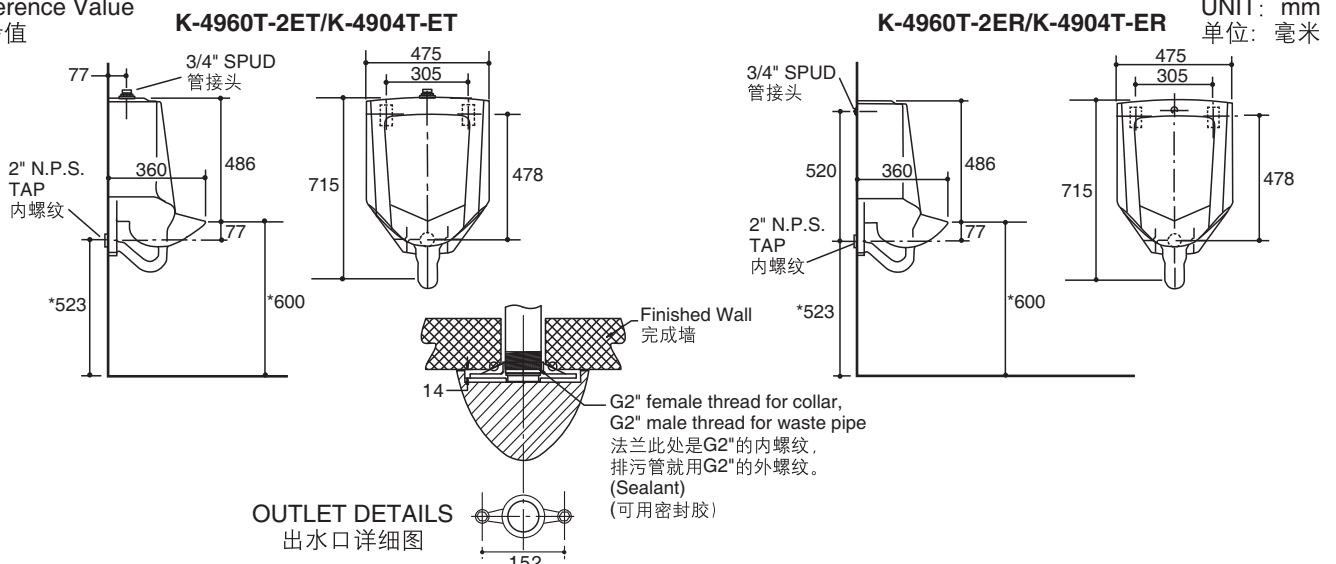

Kohler reserves the right to change marked dimensions without prior notice.  
 科勒公司保留随时变更图中标示尺寸的权利，无需另行通知。

No.2 KOHLER ROAD, SANSHUI CENTRAL INDUSTRIAL PARK, LEPING TOWN, SANSHUI DIST., FOSHAN, GUANGDONG, PRC POST CODE: 528137

广东省佛山市三水区乐平镇三水中心工业园区科勒大道2号 邮编: 528137

8# MENGSHAN RD, ECONOMIC DEVELOPMENT ZONE OF HUANTAI, ZIBO, SHANDONG, CHINA POST CODE: 256410

山东省淄博市桓台经济开发区蒙山路8号 邮编: 256410

NO.1 KOHLER STREET, ECONOMIC DEVELOPMENT ZONE OF FAKU COUNTY, SHENYANG LIAONING PROVINCE, PRC POST CODE: 110400

辽宁省沈阳市法库经济开发区科勒大街1号 邮编: 110400

## INSTALLATION

## 安装

Refer to the roughing-in drawing for proper heights of supply and waste locations. Install supply piping and waste piping in accordance with local plumbing codes.

请参照尺寸图，以确保供水管及污水管的位置正确；且须遵守当地给排水规定来安装供水管和污水管。

1. The recommended installation height from floor to centerline of waste outlet is 523mm. Fix the waste pipe with G2" male nipple protruding about 6mm from the finished wall.
2. Screw the waste fitting (supplied with urinal) to the waste pipe nipple so that the face of outlet flange is 14mm from finished wall. Refer to **OUTLET DETAILS**.
3. Place sponge rubber gasket onto waste fitting.
4. Install and adjust the hanger.
  - a. Drill two holes 478mm above the drainage hole centerline. The distance between the two holes is 305mm. Then insert the anchor sleeves.
  - b. As shown in the picture below, firmly press the hanger with the bolt through the waist-shaped hole.

1. 由地面到污水管出口中心线建议安装高度为523mm，用G2"的公螺纹接套固定污水管，公螺纹接套须凸出完工墙约6mm。
2. 将污水管装置(随产品供应)上紧于污水管螺纹接套上，出水法兰到完工墙的距离为14mm。请参考出水口详细图。
3. 把海绵橡胶密封垫圈放在污水管装置之上。
4. 安装、调整挂钩。
  - a. 距离排污口中心上方478mm处，间距305mm，钻两个适当的孔，然后打入膨胀螺丝套管。
  - b. 如下图所示，通过挂钩上的腰形孔，用螺栓压紧挂钩。

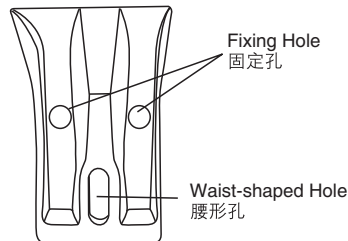

- c. Put the urinal on the hanger. Slightly push downwards to the proper position.

- c. 将小便器放在挂钩上，轻轻向下推至恰当的位置。

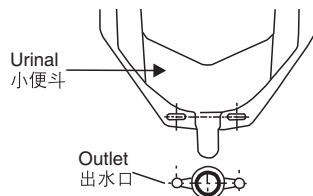

目测出水口螺丝孔与小便斗上的腰形孔上下对齐，方可正常安装  
Before installation, please make sure the outlet screw hole is align with the waist-shaped hole

- d. As shown in the picture below, if the position of the urinal needs to be adjusted, please take down the urinal and knock the hanger slightly to adjust its position upwards and downwards.

- d. 如下图所示，如果小便斗上下位置不合适，请取下小便斗，用锤子轻轻的上下敲击挂钩，调整挂钩的上下位置。

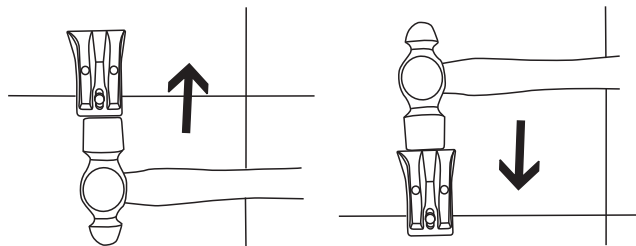

Adjust Upwards and Downwards  
上下调整挂钩位置

- e. After the position of the urinal is decided, completely fix the hanger with the bolt through the two fixing holes on the hanger. Then repeat step c.

- e. 确定挂钩位置后，通过挂钩上的两个固定孔，锁入螺栓使得挂钩完全的固定，然后重复前面c步骤。

- Secure waste fitting to urinal using the two bolts and washers supplied.
- Connect the flushometer valve to the supply nipple and urinal according to the flushometer valve manufacturer's recommendations.
- Check for tightness of all connections and turn on the water. Flush urinal and adjust the control stop on the flushometer valve for flow volume, if needed.

**NOTE:** For rear inlet urinals, when planning installation, installer must allow connection of inlet water supply behind urinal.

- 用已提供的两个螺栓和垫圈，把污水管装置固定在小便器上。
- 按冲水表阀制造商的指引，把冲水表阀接上供水管螺纹接套及小便器。
- 检查所有连接是否上紧，然后打开供水管，冲洗小便器，如有需要可调整冲水表阀上的流量调节器。

注：如果订购的是后进水小便器，当计划安装时，安装人员必须使进水连接口位于小便器的背后。

## IMPORTANT CONSUMER INFORMATION

## 用户须知

### CONSUMER RESPONSIBILITIES

If you live in a hard water area, make certain that the holes in the toilet rim are kept clean to ensure proper flushing. Toilet bowl cleaners should be used at least once a week. Use a long-handled brush to clean the rim holes, and to clean as far into the trap as possible to prevent mineral deposits from forming.

Most toilet bowl cleaners are not harmful to the vitreous china surface of the urinal. Please follow the bowl cleaner manufacturer's instructions carefully.

Do not use abrasive cleaners or solvents.

 **WARNING: Risk of property or product damage.** Do not use cleaners inside the wash basin. Products containing chlorine (calcium hypochlorite) can seriously damage fittings in the urinal. This damage can cause leakage and property damage.

Kohler Company shall not be responsible or liable for any damage to these urinal fittings caused by the use of cleaners containing chlorine (calcium hypochlorite).

 **WARNING:** Never spit phlegm and throw stub or something else into the urinal.

 **WARNING: Risk of product damage.** Do not throw into the urinal what is easy to block it, such as newspaper, paper pilch. Do not bump the vitreous china with great force to prevent it from damaging and leaking. Do not use the product in the water below 0°C.

 **CAUTION:** Please do not use hard materials (like scouring pad) to clean product surface, especially the product logo.

It is recommended to use sensors of KOHLER brand .

### 用户责任

如果你居住地方的水质是硬性，你必须保持冲水孔清洁，令小便器冲水正常。每星期应最少使用厕所清洁剂清洁一次，用长把手的刷子清洁冲水孔，并尽量伸入排污管洗刷，防止矿物质积聚。

大部份厕所清洁剂都不会损坏小便器表面的釉面陶瓷，但烦请遵照厕所清洁剂生产商指示小心进行。

请勿使用腐蚀性剂或溶剂。

 **警告：**提防楼宇受损或损坏产品。请勿使用小便池内用清洁剂。含氯(次氯酸钙)的清洁剂会严重破坏小便器附件，从而引起渗漏，或对楼宇结构造成损坏。

科勒公司对此类因使用氯(次氯酸钙)而引致的小便器附件损毁，概不负责。

 **警告：**请勿往小便器内吐痰、扔烟蒂等杂物。

 **警告：**提防损坏产品。请不要向小便器内冲入新闻纸、纸尿垫等容易堵塞的物品。请不要用重力撞击陶瓷，以防止破损漏水。

不要在0°C以下的水环境中使用。

 **警告：**请勿使用钢丝球等硬质材料擦洗产品表面，特别是产品商标处。

推荐使用科勒配套感应器。

Urinal & Sensor matching table (附：小便斗与感应器配套表)

Urinal (小便斗)	Sensor (配套感应器)
4904T (0.5L)	8881T-YC01/YC03-BN, 8791T-YC01/C03-CP/SC
4960T(1L)	8881T-C01-BN, 8988T-C01/C03-CP/SC
4960T(2.5L)	8787T-B01/B03-CP/SC, 8791T-C01/C03-CP/SC, 8872T-C01/C03-CP, 8828T-C01-CP