

NOTE: BEFORE CUTTING COUNTERTOP
ALLOW FOR HANDLE CLEARANCE.

FINISHED WALL / BACK SPLASH

51mm MIN
[2.0"]

64mm MIN
[2.5"]

CENTERLINE OF FITTING

4-R20

KOHLER®

K-26270ID FOREFRONT BRINK

VESSEL W/O DECK 600MM
CUT-OUT TEMPLATE / INSTALLATION INSTRUCTIONS

BEFORE YOU BEGIN

- Observe all local plumbing and building codes.
- Inspect the waste and supply tubing; replace if necessary.
- Prior to installation, unpack the new lavatory and carefully inspect it for damage. Return the lavatory to its protective carton until you are ready to install it.
- For replacement installations, make sure the existing cutout is the same or smaller size as the new lavatory.
- Use the template supplied with the lavatory to mark correct size cutout.
- Kohler lavatory is made according to American National Standard that it can match the American lavatory fittings. Any other lavatory fittings may not fit for Kohler lavatory.
- Fixture dimensions are nominal and conform to tolerances established by ASME Standards (A112.19.2-2018).
- Need to match the lifting rod type small cover water dropper, if the length of the lifting rod faucet is not enough, please purchase another accessory 880089-CP to cooperate with the installation.

TOOLS AND MATERIALS (Not Supplied)

- Template (supplied)
- Safety glasses
- Pencil
- Scissors
- Tape measure
- Putty knife
- Plumbers putty
- Hacksaw
- Keyhole saw or saber saw
- Drill (13mm or 1/2" dia. drill bit or larger)
- Adjustable wrench
- Pipe wrench
- Tubing cutter

ROUGHING-IN

Reference Value (Unit: mm)

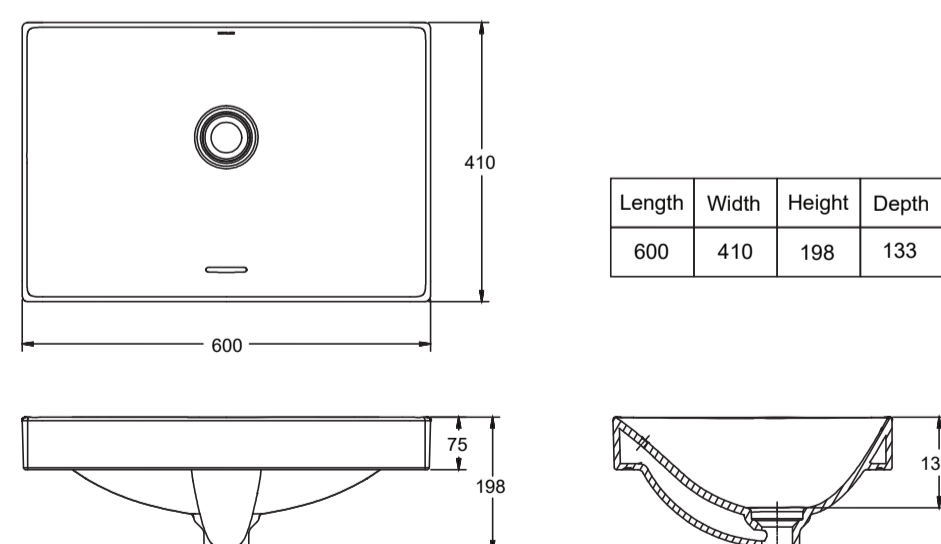

Kohler reserves the right to change marked dimensions without prior notice.

INSTALL NEW LAVATORY

- Cut the template on the cutout line.
- Locate the installation position. Make sure the overflow hole is on the front of the countertop and the logo is on the faucet side.
- Position the template on the countertop to ensure clearance between the lavatory, faucet, and back splash.
- Verify cabinet clearance beneath the countertop.
- Trace the template on the countertop with a pencil.
- Re-check the clearance between the lavatory, faucet, back splash, and cabinet. Adjust the template accordingly.
- Drill a 13mm hole on the inside of the cutout opening.
- Cut the opening in the countertop along the inside edge of the pencil line.
- Correct cut the tap mounting hole according to the tap and countertop dimensions.
- Temporally position the lavatory in the opening and adjust to fit.
 - ⚠ **CAUTION: Risk of personal injury or product damage.** Large lavatories are very Get help lifting the lavatory into place.
- Trace a pencil line around the outside edge of the lavatory.
- Remove the lavatory.
- Install the faucet and drain according to the manufacturers instructions.
- Apply two beads of sealant to the inside of the pencil line.
- Spread the sealant evenly with a putty knife.
- Carefully position the lavatory in the cutout, and press down firmly.
 - ⚠ **CAUTION: Risk of personal injury or product damage.** Large lavatories are very Get help lifting the lavatory into place.
- Immediately wipe away any excess sealant, and fill any voids as needed.
- Verify that the lavatory has not moved out of position.
- Allow the sealant to cure for at least 30 minutes before proceeding.
- Connect the faucet supply lines.
- Connect the drain assembly.
- Install the decorative cap in the installation groove.
- Open the faucet valves, and check for leakage.
- Clean up with a non-abrasive cleaner.

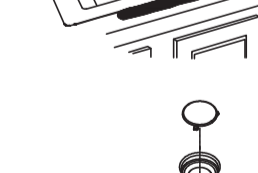
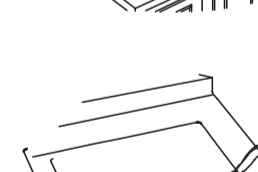
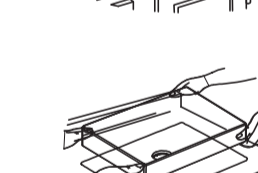
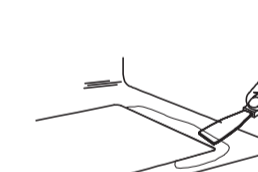
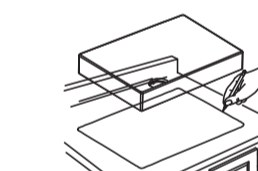
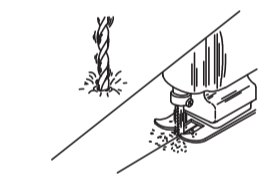
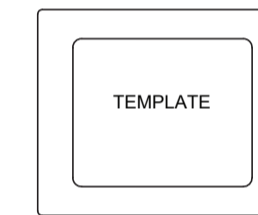

IMPORTANT CONSUMER INFORMATION (CARE AND CLEANING)

To keep your lavatory looking new, make sure you rinse it out thoroughly after each use.

DO NOT USE ABRASIVES on this product, as they will scratch and ruin the surface. Stubborn stains, paint, or tar can be removed with turpentine or paint thinner.

Do not use the product in the water below 0 °C.

⚠ **CAUTION:** Please do not use hard materials (like scouring pad) to clean product surface, especially the product logo.

SERVICE PARTS

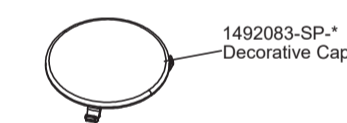

Customer Care Center

ASIAN EMERGING MARKETS
Asia Customer Service Centre, Kohler Asia Pacific Limited
No. 158, Jiang Chang San Road, Zhabei District, Shanghai,
PRC. 200436.
Tel: +(86) 21 2606 2572 Fax: +(86) 21 6107 8900

Kohler Indonesia Customer Care Center
PT. Kohler Indonesia
Plaza Galeon 10th Floor
Jl. MH. Thamrin kAV. 8-9, Jakarta Pusat
Tel: +62 21 5088 9524
e-mail: kohlerindonesia@kohler.com

CUT ALONG THIS LINE

WHEN PLOTTING TEMPLATE FULL SIZE:
Make sure horizontal and vertical dimensions
match the dimensions labeled on the template.

360mm
[14.2"]

28mm
[1.1"]

RIM OF LAVATORY

490mm
[19.3"]

1666628-ID7-A