

Installation Guide 安装说明

BUBBLEMASSAGE® BATH
泡泡浴缸

上海科勒有限公司
上海市奉贤区民乐路368号 邮编：201419

Before You Begin

- Please read these instructions carefully to familiarize yourself with the required tools, materials, and installation sequences. Follow the sections that pertain to your particular installation. This will help you avoid costly mistakes. In addition to proper installation, read all operating and safety instructions.
- All information is based on the latest product information available at the time of publication. Kohler Co. reserves the right to make changes in product characteristics, packaging, or availability at any time without notice.
- These instructions contain important care, cleaning, and warranty information-**please leave these instructions for the consumer.**

Product Notices

A. Installation Hazard Notification

DANGER: Risk of fire, electric shock, or injury to Persons. Read important safety instructions included in these instructions.

 **WARNING: Risk of electrical shock.** A licensed electrician should make all electrical connections.

 **WARNING: Risk of electrical shock.** Connect only to a circuit protected by a Ground-Fault Circuit-Interrupter (GFCI) or Earth-Leakage Circuit-Breaker (ELCB).

 **WARNING: Risk of electrical shock.** Disconnect power before servicing.

 **WARNING: Risk of injury or property damage.** Please read all instructions thoroughly before beginning installation, including the following Product Requirements.

NOTICE: Follow all local plumbing and electrical codes.

 **WARNING: Keep the area around the blower motor clean and free of debris.** Ensure that the area around the blower motor is free of sawdust, insulation, dirt, or other small loose debris. Such material could clog the blower motor air ducts and reduce the air flow through the blower.

B. Factory-Assembled Features

Factory installed components include blower motor with power supply cord, check valve, air piping, user keypad, and keypad cable. Other than power wiring and plumbing, no assembly is needed.

 **WARNING: Unauthorized modification may cause unsafe operation or affect performance of the bath with airjets.** Do not relocate the blower motor, or make other modifications to the system in the absence of kit instructions, as this could adversely affect the performance and safe operation of the bath with airjets. Kohler China shall not be liable under its warranty or otherwise for personal injury or damage caused by any such unauthorized modification.

Product Requirements

A. Summary Of Key Requirements

- Observe all local plumbing codes.
- Install the unit to a level subfloor.
- Provide properly-dimensioned framing.
- Baths with airjets are designed for a variety of installations, depending upon the model chosen.

B. Plumbing Specifications

If using a rim-mounted bath faucet, flexible connections between the valves and spout may be required. Confirm adequate mounting, connection space of specified faucet for your installation.

C. Product Inspection

Carefully unpack and inspect the bath with airjets for damage. Leave all materials in the carton during constructions to prevent damage.

D. Electrical Requirements

The installation must have a Class A Ground-Fault Circuit-Interrupter (GFCI). The GFCI protects against Line-to-ground shock hazard. Use a 220-240 V, 10 A (minimum), 50 Hz dedicated service for the bath with airjets.

Installation Requirements

A. Tools Required

- Adjustable pipe wrench
- Rule
- Level
- Safety shoes
- Safety glasses
- Square
- Screwdriver
- Pliers
- Utility knife
- Pencil
- Measuring Tape

Plus:

- Conventional woodworking tools and materials or conventional bricklaying tools and materials
- Drop Cloth
- Construction adhesive (optional)
- Cement or mortar (optional)
- 2x4's or 2x6's

B. Materials Required

- Plumbers putty
- Wall coverings, as necessary
- Silicone sealant
- Gypsum cement (optional)
- Construction adhesive (optional)
- Protective covering for bathtub
- Nails
- Silicone Sealant

Site Requirements

A. Old Bath Removal (If Applicable)

Disconnect the drain at the trap. Remove the old wall material. Slip boards under the old bath feet to protect the floor, and slide the old bath out of the recess as illustrated.

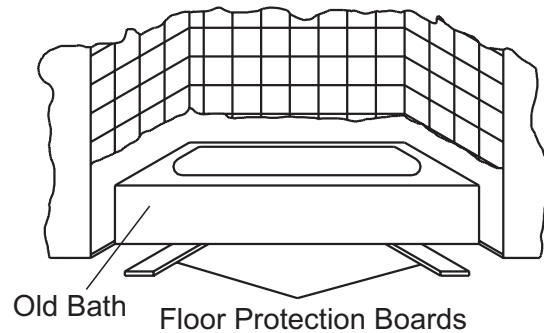

B. Prepare the Site

CAUTION: Risk of product damage. Do not support the bath by the rim.

NOTICE: Unless otherwise specified, floor support under the bath must provide for a minimum of 80 lbs./square foot (390 kg./square meter) loading.

NOTICE: Provide adequate ventilation and a minimum of 15 cubic feet (.4 cubic meters) in the installed location for cooling the motor and to supply sufficient air for the blower. Do not install the blower motor closer than 2.5mm from the wall or other objects.

- Make sure the flooring offers adequate support for your bath, and verify that the subfloor is flat and level.
- This bath may be installed in a drop-in or in an island installation. An island installation requires a four side surround. In both instances, make sure the deck is adequately supported.
- Install an access panel to allow the blower to be serviced. Jalousie access is recommended. Please refer to rough-in for exact location of access panel.
- Construct brick or concrete supports.
- Provide a 2mm gap between the bath rim and the concrete or brick framing.

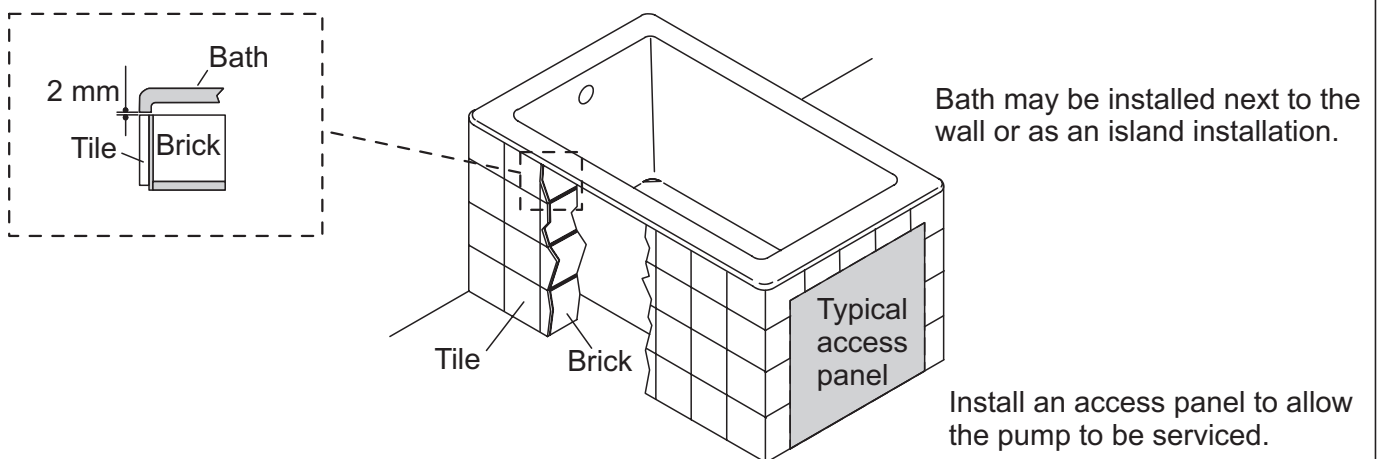

C. Bubble Area Construction Preparation (Optional)

Make sure you allow for access to the pump in the event the unit requires service. When constructing the framing, allow for the thickness of sub and finish wall material (e.g. mortar mix and ceramic or marble tiling).

Drop In Installation: Refer to rough-in notes for cut-out details. Make sure the bubble is supported by the supporting feet on the bottom of the bubble. Do not hang the bath by the rim.

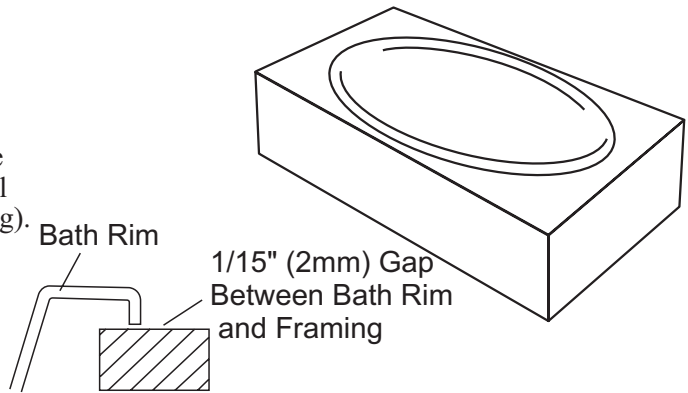

Before Installing the Bath

A. Your new bubble has been manufactured to the highest possible standards, it has been factory tested and approved.

B. When removing bath from protective carton **DO NOT LIFT BATH BY PIPE WORK**. Inspect for any possible damage that may have occurred in transit. Position a clean drop cloth or similar material in the bottom of the bath to protect the finish. Be careful not to scratch the surface of the bath.

C. Identify blower and switch access location before proceeding with installation.

NOTE: NO BLOWER AND SWITCH ACCESS NO WARRANTY SERVICE. Ventilation must be provided to access panel in order to allow heat from blower to dissipate. Jalousie access is recommended.

D. IMPORTANT: Bath must be installed level on all top edges.

E. Install the drain to the bath according to the drain manufacturer 's instructions. Do not connect the trap at this time.

Install the Bath

⚠ CAUTION: Risk of product damage. Do not lift the bath with airjets by the air channels or blower motor, or use the air channels or blower motor for structural support of the bath.

⚠ CAUTION: Risk of product damage. Do not support the bath by the rim.

If the subfloor is not level, shim the bath support blocks as necessary.

A. Choose to Use Concrete or Mortar Bed

NOTE: Do not use gypsum concrete or drywall compound for this application, as they will not provide an acceptable, durable bond.

- Spread a 50mm thick layer of cement or mortar on the subfloor where the bath will be set. This will help secure, level, and support the unit.
- Position a piece of plastic drop cloth material on top of the cement or mortar bed.
- With help, carefully lift the bath into place.
- Insert the drain tailpiece into the floor drain. Make sure the bath is level and all feet are sufficiently supported.
- Remove the protective tape from the rim.

B. Install the Plumbing

⚠ CAUTION: Risk of property damage. Ensure a watertight seal on the bath drain.

- Connect the drain to the trap according to the manufacturer's instructions.
- Run water into the bath, and check the drain connections for leakage.
- Install the faucet valving according to the faucet manufacturer's instructions. Do not install the faucet trim until instructed. Open the hot and cold water supplies, and check the supply connections for leakage.

NOTE: An access panel will simplify future maintenance.

C. Make Electrical Connections

⚠ WARNING: Risk of electric shock. To reduce the risk of electrical shock, connect the control box to a properly grounded, grounding-type receptacle protected by Ground-Fault Circuit-Interrupters (GFCI's). Do not remove the plug grounding pins. Do not use grounding adapters.

NOTE: The bath with airjets model number is printed on a label near the blower motor. This label also identifies the electrical rating.

- Your Kohler bath with airjets is equipped with a cord and plug. The blower motor has been wired at the factory. A licensed electrician must install a dedicated GFCI-protected, 220 V, 10 A, grounded outlet.
- Plug the control box into this outlet.
- Clean the area of all dust and debris.

D. Test Run the Bath with Airjets

- For information on unit operation, refer to the "Confirm Proper Operation" section.
- Check all electrical connections, and make sure the electrical power to the bath with airjets is on.
- Make sure all piping connections in the air harness are secure.
- Verify that the blower motor is secure.
- Temporarily remove the plastic drop cloth or other protective sheeting from the bath.
- Fill the bath to a level at least 50mm above the top of the highest airjet.
- Check the drain piping for leaks. Repair any leaks.
- Operate the bath and check for air flow through the airjets. Check the air piping for air leaks.
- Stop the bath and drain the water.
- Return the plastic drop cloth or other protective sheeting to the bath. Check the drain connections for leakage.

E. Drop-In Models:

⚠ CAUTION: Risk of product damage. Do not support the weight of the bath by the rim.

For sunken type installation, construct the ceramic or marble tiles. Seal the joints between the bath rim and the tiled wall with silicone sealant.

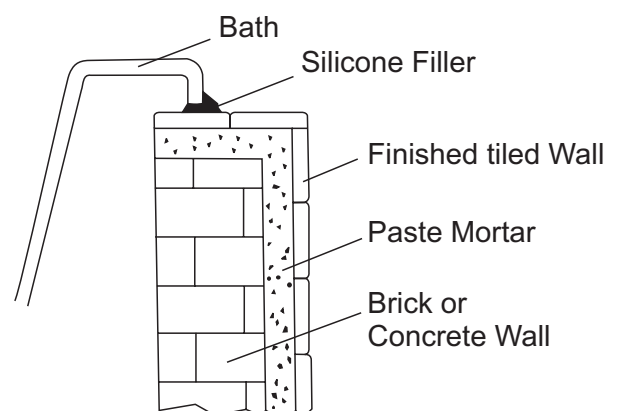
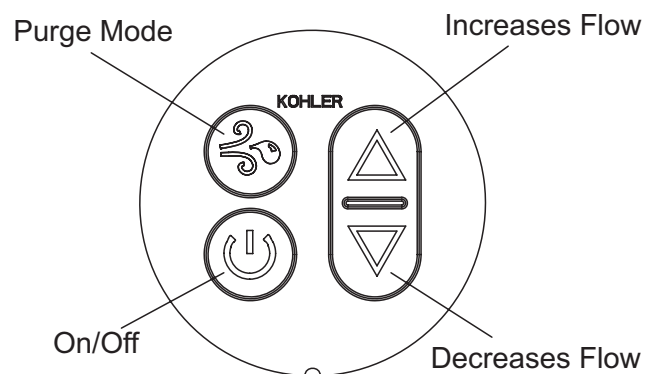

F. Drilling And Cutting Acrylic

DRILLING: Small holes can be drilled with a twist drill, but the cutting edge **MUST** be backed off with an oil stone (the sharp edge dulled). Large holes must be drilled with a hole saw. Maximum drill size-12mm. Drill speeds-6mm × 1800 RPM-12 mm × 900 RPM.

NOTE: Always drill from acrylic surface.

CUTTING: If for any reason the acrylic requires cutting, use a fine tooth hacksaw and proceed with caution. Edges can be smoothed with a second-cut file and medium-fine sandpaper. If the surface of the acrylic should happen to be damaged, it can be restored by polishing with an abrasive cleaner. Deep scratches can be removed by rubbing with 600 grade wet & dry sandpaper then polishing.

G. Clean-Up After Installation

- Clean the area around the blower motor of all dust and debris.
- Use warm water and a liquid detergent to clean the surface of the bath with airjets. **Do not use abrasive cleansers**, as they may scratch and dull the surface. **Do not use powdered cleaners unless the cleaner is fully dissolved in water.** Solid substances could block the airjets. **Do not use bleach or ammonia cleaning solutions.** Chemically active cleaning solutions can damage the bath surface. Refer to the homeowners guide for normal cleaning recommendations.

Bath Operation

A. Fill the Bath

- ⚠ **CAUTION: Risk of product damage.** Ensure that the area around the blower motor is free of sawdust, insulation, dirt, or other small loose debris. Such material could clog the blower motor air ducts and reduce the air flow through the blower motor.

NOTE: Please read these steps carefully before you operate your bath with airjets. Troubleshoot any problems using the "Troubleshooting" section.

B. Keypad Operation

- **On/Off** - Turns the blower motor on and off. Pressing the switch once starts the blower motor at a low speed. Pressing the button again stops the blower motor. The blower motor automatically stops after about 20 minutes of operation. The blower motor can be restarted by pressing the On/Off button.
- **Purge Mode** - Initiates the purge cycle manually. The purge cycle blows any residual water out of the air channels after the bath has been drained. Pressing the button once starts the blower motor at low-speed. The blower motor stops automatically after about two minutes. Pressing the button again before the cycle ends will stop the blower motor. Note that this product also has an automatic purge cycle, which initiates about 30 minutes after the blower has stopped.
- **Increases Flow** - Increases the air flow.
- **Decreases Flow** - Decreases the air flow.

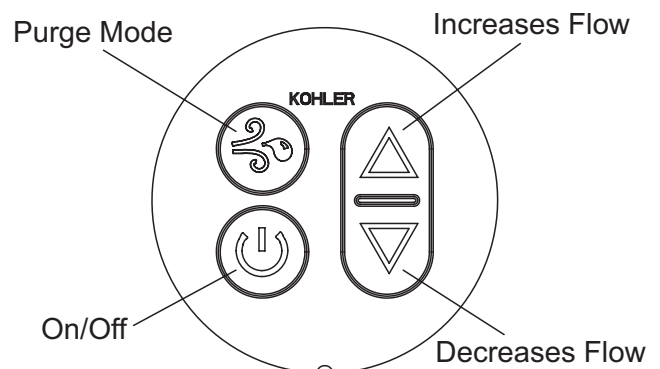

C. Preliminary Checks

- Temporarily remove all access panels.
- Verify that the union connection at the check valve is securely hand tightened.
- Verify that the screws are installed in the PVC air piping at the blower motor and at the check valve.
- Verify that cable ties support the air piping.
- Verify that the blower motor is secure.
- Verify that the keypad cable is securely connected at the user keypad and at the blower motor.
- Fill the bath to a level at least 50mm above the top of the highest airjet.

D. Confirm Air System Operation

- Press the power button on the user keypad.
- Observe that the blower motor starts at a low speed.
- Observe that air is blowing through all of the airjets.
- Press the up button on the user keypad.
- Verify that the air flow increases.
- Press the down button on the user keypad.
- Verify that the air flow decreases.
- Press the power button on the keypad to stop the blower motor.

E. Confirm Manual Purge Operation

- Drain the bath.
- When the bath has drained, press the purge button once.
- Observe that the blower motor starts at low speed and blows any residual water from the air channels.
- Observe that air comes out of the airjets.
- Verify that pressing the purge button again stops the blower motor.
- Press the purge button to restart the manual purge.
- Observe that the blower motor stops automatically after about two minutes.

F. Confirm Automatic Purge Operation

- Press the power button.
- Press the power button again to turn off the blower. Note the time.
- If filled, drain the bath.
- Observe that the blower motor starts in the purge cycle after about 30 minutes.
- Observe that the blower motor stops automatically after about two minutes.

Troubleshooting Chart

SYMPTOMS	PROBABLE CAUSES	RECORRECTIVE ACTION
1. Bath with airjets does not start.	A. No power to blower motor.	A. Set/reset GFCI or ELCB breaker; check wiring.
	B. User keypad cable loose or damaged.	B. Check wire connections. If necessary, replace user keypad cable.
	C. User keypad does not work.	C. Check wire connections. Replace user keypad.
	D. Blower motor does not work.	D. Replace blower motor.
2. Blower motor starts, but there are few or no bubbles.	A. Blower motor is disconnected.	A. Connect blower motor to air harness.
	B. Blower motor air flow is restricted.	B. Clean the area around the blower motor. Ensure adequate ventilation.
3. Bath stops automatically before 18 minutes.	A. GFCI or ELCB trips.	A. Identify source of fault and correct.
	B. Motor overheated and protection device activated.	B. Check for blockage at motor vents. Remove blockage and allow motor to cool.
4. Bath does not stop automatically after 22 minutes.	A. Blower motor does not work.	A. Replace blower motor.
5. Blower motor does not stop when power button on user keypad is pressed.	A. User keypad cable loose or damaged.	A. Check wire connections. If necessary, replace user keypad cable.
	B. User keypad does not work.	B. Replace user keypad.
6. Blower motor operates but variable speed feature does not work.	A. User keypad cable loose or damaged.	A. Check wire connections. If necessary, replace user keypad cable.
	B. User keypad does not work.	B. Replace user keypad.
	C. Blower motor does not work.	C. Replace blower motor.
7. Automatic purge cycle does not occur.	A. Blower motor does not work.	A. Replace blower motor.
8. Manual purge cycle does not work.	A. User keypad cable loose or damaged.	A. Check wire connections. If necessary, replace user keypad cable.
	B. User keypad does not work.	B. Replace user keypad.
	C. Blower motor does not work.	C. Replace blower motor.

Important Consumer Information

Consumer Responsibilities

Please confirm that the bubble massage bath is installed according to the installation instructions.

Massage system should be used at least once a month to avoid the possibility that the electrical fittings be damaged because of excessive moisture.

Cleaning Acrylic Surfaces: Do not use abrasive cleansers on any acrylic surfaces, as they will scratch and dull the surface. Wipe out the bath after each use to prevent a build-up of soap and scum.

If the acrylic surface becomes dull, an automotive type rubbing compound *may be used on the unit, followed by an application of paste wax.

*We recommended:

Rubbing compound mequiars mirror glaze 28 metal polish (import product) or "green oil".





安装之前

- 请仔细阅读此说明书以熟悉所需要的工具、材料及安装顺序。遵循适合您的特定安装要求的各项内容，避免昂贵的损失。除了要正确安装外，还应阅读操作及安全说明。
- 所有的资料是按最新出版的产品资料编写而成。科勒中国有限公司保留任何时候无须通知即可改变产品特性、包装或产品可供类型的权利。
- 说明书包括重要的安装、清洁及保养方面的内容，请把这些资料交给用户阅读。

产品注意事项

A. 安装危险警告

危险：有起火、触电或人员受伤的危险。 请阅读本说明书内的重要安全指示。

-  **警告：有触电的危险。** 请找合格的电工来进行所有的线路连接。
-  **警告：有触电的危险。** 仅能和由接地故障断路器(GFCI)保护的电路相接。
-  **警告：有触电的危险。** 工作之前先切断电源。
-  **警告：有受伤或财物受损的危险。** 开始安装之前，请先彻底阅读所有说明，包括以下的产品要求。

注意：请遵守所有的本地卫生管道和电气规范。

-  **警告：请保持气泵周围区域清洁，没有任何残留物。** 请确保气泵周围区域没有任何锯屑、绝缘物、尘土，或者其它小的松散的残留物。这些残留物可能导致气泵通风口堵塞，从而使通过气泵的气流不畅。

B. 由厂家组装的部件

工厂已经对部件进行了安装，包括带电源线的气泵、单向阀、空气管道、控制面板、信号线等。除了电源线和管道连接，不再需要任何安装。

-  **警告：未经授权的更改会导致浴缸不安全运转或者影响泡泡浴缸的性能。** 在没有专业人员的指导下，请不要移动气泵，或者对系统进行任何更改，因为这样可能导致浴缸不安全运转或者影响泡泡浴缸的性能。由于此种未经授权的更改所导致的人员伤害或损失，科勒公司将不承担任何保修责任或赔偿责任。

产品要求

A. 关键要求的总结

- 请遵守当地的卫生管道施工规范。
- 在水平地面上安装浴缸。
- 提供适当尺寸的结构。
- 泡泡浴缸的设计适用于不同的安装方式，请按型号来选定。

B. 卫生管道规格

如果是在浴缸边缘安装水龙头，必须以软管连接阀体和水龙头，确认安装是否适当，及指定的水龙头连接空间是否足够。

C. 产品检查

小心打开包装箱并检查泡泡浴缸是否损坏，施工期间将所有的材料都留在箱内，以防止损坏。

D. 电气要求

安装时必须要有A级接地事故断路(GFCI)。GFCI可避免线路接地触电的伤害。请使用一条220-240伏特，10安培(最小)，50赫兹的专用电路供泡泡浴缸使用。

安装要求

A. 所需工具

- 管道扳手
- 刻度尺
- 水平仪
- 安全鞋
- 安全眼镜
- 直角尺
- 螺丝刀
- 钳子
- 多用工具刀
- 铅笔

附加:

- 常规木工和砖瓦工的工具和材料
- 垫布
- 建筑粘胶(选用)
- 水泥或灰泥(选用)
- 2x4' 或 2x6'支撑架

B. 所需材料

- 管道用油灰
- 墙面保护罩(如需要)
- 密封硅胶
- 石灰水泥(选用)
- 建筑粘胶(选用)
- 浴缸保护套
- 钉子
- 密封硅胶

场所要求

A. 拆除旧浴缸

在存水弯处拆下排水管。清除所有旧墙材料。在旧浴缸下面塞入护板以保护地面，并如图所示把旧浴缸从安装空间拉出。

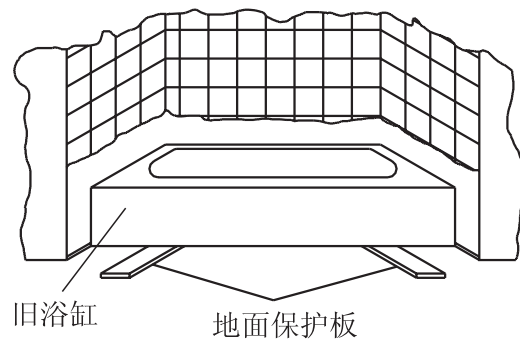

B. 场所准备

⚠ 警告：存在产品受损危险。 请不要仅靠浴缸边缘支撑浴缸。

注意：除非特别注明，浴缸下面的底层地面必须提供至少80磅/平方英尺(390公斤/平方米)的荷载承重。

注意：在安装位置，提供足够的通风，有效通风口面积应不小于5000平方毫米以及至少15立方英尺(0.4立方米)的空间，以冷却发动机，并为气泵供应足够的空气。不要将气泵安装在离墙或者其它物体25毫米以内的位置。

- 确保地面具有足够的支撑力支撑您的浴缸，并核实底层地面是水平的。
- 此浴缸可进行嵌入式安装或者岛屿式安装。岛屿式安装需要四面均有围墙。两种安装方式下，均要确定浴缸周边有足够的支撑。
- 为维修气泵提供维修入口，建议使用百叶窗式检修门。维修入口位置参见尺寸图。
- 建造砖头或者混凝土框架。
- 在浴缸边缘和柱型框架之间保留一个2毫米的缝隙。根据您的浴缸随附的初步安装信息在地面上确定安装位置。

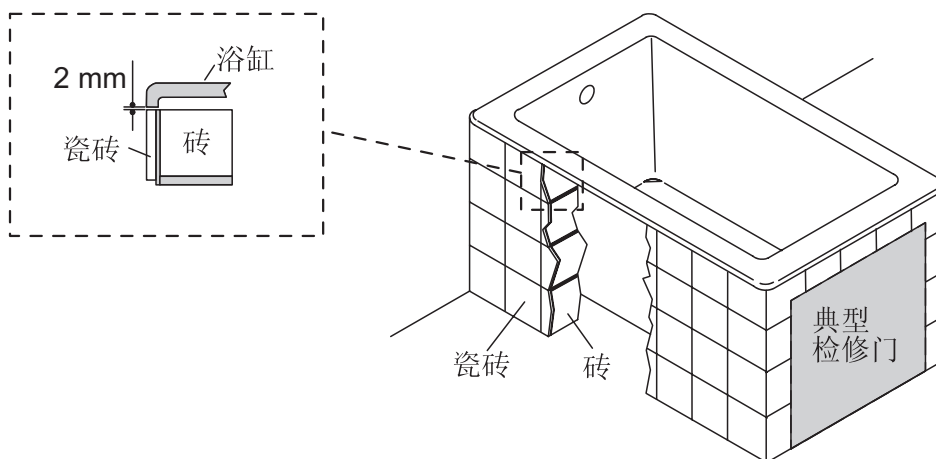

浴缸可以靠墙安装或岛屿式安装。

为气泵及控制面板提供检修门。

C. 泡泡浴缸支撑结构的准备(选用)

确保为水泵预留空间，以便于维修。建立结构时，请预留底层地面和完工墙壁材料的厚度(例如水泥砂浆和瓷砖或大理石)。

嵌入安装：有关切割图样的细节请参阅安装尺寸说明。
务必使泡泡浴缸底部的支撑脚支撑。
不要使浴缸靠边缘悬挂。

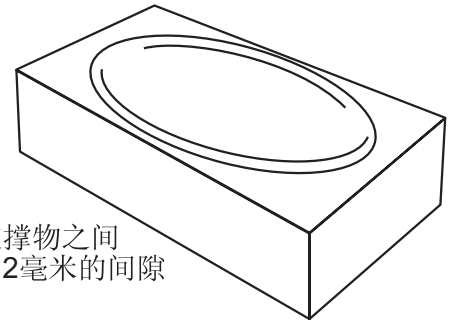
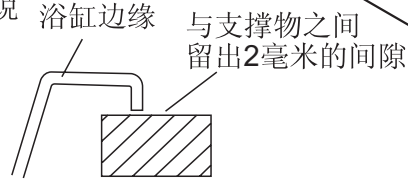

安装泡泡浴缸之前

A. 本泡泡浴缸质量上乘，已经工厂检测通过。

B. 从起保护作用的纸箱中取出时，**请不要拎着管道部分将浴缸取出**。检查可能有搬运造成的损伤。放置时在浴缸底部垫上一块干净的布或类似材料，以保护浴缸表面的光洁度。注意：不要在浴缸表面造成划痕。

C. 安装前，请确定气泵和开关检修门的位置。

注意：无气泵和开关维修口，不能获得保修。检修门应通风良好，保证气泵散热。建议使用百叶窗式检修门。

D. 注意：浴缸必须水平地放置。

E. 根据排水装置安装的说明，将排水装置安装到浴缸上。注意此时不要连接存水弯。

安装浴缸

⚠ 警告：存在产品受损危险。 请不要利用通气管或气泵抬起泡泡浴缸，或者利用通气管或气泵作为浴缸的支撑物。

⚠ 警告：存在产品受损危险。 请不要仅靠浴缸边缘支撑浴缸。

如果底层地面不够水平，根据需要，利用垫片调整浴缸支撑脚的高度。

A. 选择使用混凝土或砂浆层

注意：在此操作中，请不要使用石膏混凝土或者清水墙混合物，因为他们不能提供足够的持久的粘合力。

- 在浴缸将要置入的位置的底层地板上涂上50毫米厚的一层混凝土或者砂浆层材料。这将有助于支撑浴缸，让浴缸更安全、更水平。
- 在混凝土或砂浆层上放一片塑料布或刷一层防水涂料。
- 将浴缸小心地放置到位。
- 将排水件插入地漏。确保浴缸处于水平位置，所有的支撑脚得到支撑。
- 将浴缸边缘的保护胶带移走。

B. 管道安装

⚠ 警告：存在产品受损危险。 请确保浴缸落水装置的水密性。

- 根据落水装置的说明，将落水装置和下水管道连接起来。
- 将水注入浴缸，检查排水连接是否漏水。
- 根据龙头生厂商的说明，安装水龙头阀门。在没有相关指示前，请不要安装龙头装饰物。打开冷热水进水口，检查供水连接是否漏水。

注意：预留检修门将有助于将来的维修。

C. 管道安装电路连接

⚠ 警告：存在触电危险。 为降低触电危险，请将控制盒和正确接地的受接地故障线路断路器GFCI保护的接地型插座相连接。请不要移动接地插头。不要使用接地适配器。

注意：泡泡浴缸的产品型号印刷在靠近气泵的一边标签上。此标签上同时注明了使用的额定电压和电流。

- 您的科勒泡泡浴缸附带有电线和插头。所有电路连接已经在工厂完成。请由一名持证电工将安装一个专用的220伏特、10安培的受到GFCI保护的接地插座。
- 将气泵插头插入此插座。
- 将控制盒周围的尘土和碎屑清除干净。

D. 测试泡泡浴缸的运转

- 如需浴缸操作信息，请参照“确认正确操作”部分。
- 检查所有的电路连接，确保浴缸连接电源部分是打开的。
- 确保气管道的所有管道连接安全。
- 核实气泵安全。
- 暂时从浴缸上拿走塑料布或其他保护性材料。
- 注水入浴缸，水量至少达到最高的气口顶部以上50毫米。
- 检查排水管道是否漏水。如果有任何漏水现象，及时修理。
- 启动浴缸，检查气口的气流状况。检查气管道是否漏气。
- 关闭泡泡浴缸，进行排水。
- 将塑料布或其他保护性材料放回原位。

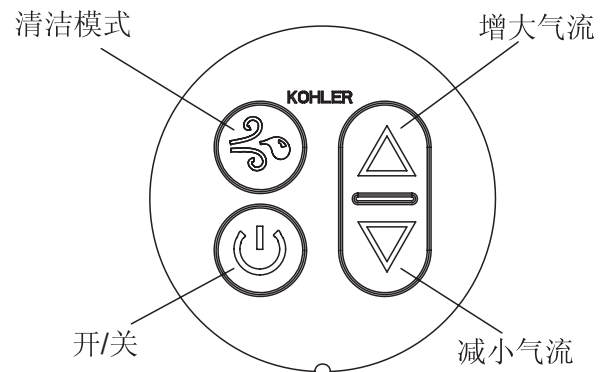

E. 无裙边浴缸类型：

⚠ 注意！！当心损坏浴缸！ 不要靠浴缸边缘支撑浴缸的重量。

对嵌入式安装，在敷上瓷砖或大理石贴面后，再用硅胶密封浴缸边缘和贴面的连接处。

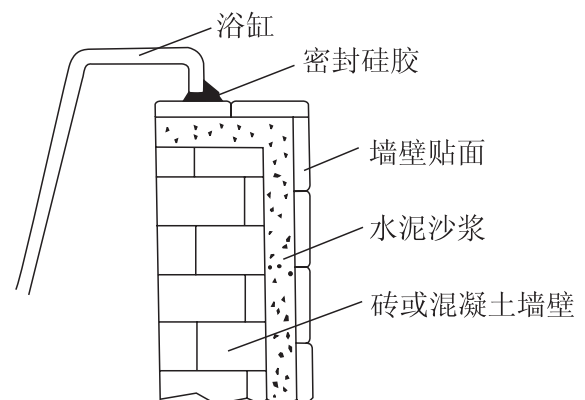

F. 在压克力表面上钻孔和切割

钻孔：可用一麻花钻头钻小孔，但切削刃必须用一块油石磨钝。大孔须用孔钻加工。麻花钻头的最大尺寸为12mm，速度为6mm × 1800转/分至12mm × 900转/分。

注意：钻孔要从压克力表面钻向浴缸背面。

切割：如果因故需要切割压克力，请用优质齿型钢锯仔细切割。边缘可用一旧锉刀及中等砂纸磨平。如果压克力表面受损，可用磨蚀性清洁剂抛光，将其恢复。深度刮伤可用600号水砂纸磨平，然后抛光。

G. 安装之后的清理工作

- 将气泵周围的尘土和碎屑清理干净。
- 使用温水和液体清洁剂清洗泡泡浴缸表面。请不要使用磨损性的清洗剂，因为他们会擦伤浴缸表面，或者损伤浴缸表面的光洁度。请不要使用粉状清洁剂，除非这种清洁剂能够完全融于水。固体物质会堵塞气口。也不要使用漂白剂或者含氨类清洁剂。含化学物质的清洁剂将有损于浴缸表面。如果需要正常的清洁剂和清洁方法，请参照家庭用户指南。

浴缸操作

A. 注水入浴缸

⚠ 警告：存在产品受损危险。 确保气泵周围区域没有任何锯屑、绝缘物、尘土、或者其他小的松散的碎屑。此类物品会堵塞气泵通气口，降低通过气泵的空气流动。

注意：在操作你的泡泡浴缸之前，请仔细阅读这些步骤。如果有任何故障，请参照“故障排除”部分。

B. 控制面板操作

- **开/关** 打开和关闭气泵。摁下按钮一次，则气泵以低速率开始运转。再次摁下按钮，则气泵停止运转。在运转大约20分钟后，气泵将自动关闭。摁下开/关按钮，则气泵再次开始运转。
- **清洗模式** 手动启动清洗循环。在浴缸排水完毕后，清洗循环将吹干所有气通道中残留的水分。摁下清洗模式按钮，则气泵以较低速率开始运转。在运转大约2分钟后，气泵将自动关闭。在清洗循环终止之前摁下按钮，气泵将停止运转。请注意，此产品有自动进行清洗循环的功能，在气泵停止运转后大约30分钟左右自动启动。
- **气流增强** 增强气流
- **气流降低** 降低气流

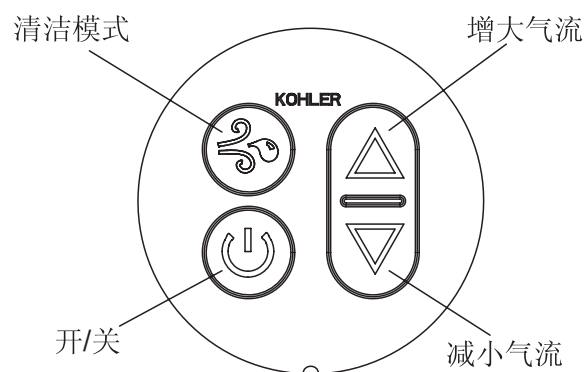

C. 初步检查

- 暂时移走所有的检修门。
- 请核实单向阀的管子接头已经安全地手动拧紧。
- 请核实气泵和单向阀的PVC气管上的螺丝正确安装。
- 请核实气管道得到适当支撑。
- 请核实气泵的安全。
- 请确认控制面板和水泵与所有线路安全连接。
- 注水入浴缸，水量至少达到最高的气口顶部以上50毫米。

D. 确认气泡系统的操作

- 摁下控制面板上的开关按钮。
- 观察确认气泵以低速率开始运转。
- 观察并确认所有的气泡孔都有气泡冒出。
- 摁下控制面板上的气流增强按钮。
- 核实气流增强。
- 摁下控制面板上的气流降低按钮。
- 核实气流降低。
- 摁下控制面板上的电源按钮，终止气泵的运转。

E. 确认手动清洗操作

- 排干浴缸的水。
- 在水排干后，摁下清洗按钮。
- 观察并确认气泵以低速开始运转，并吹干所有气管道中残留的水分。
- 观察并确认气泡从气孔中喷出。
- 核实再次摁下清洗按钮，气泵将停止运转。
- 摁下清洗按钮，重新启动手动清洗循环。
- 观察并确认气泵在大约两分钟后自动停止运转。

F. 确认自动清洗操作

- 摁下电源开关。
- 再次摁下电源开关，停止气泵的运转，请记下时间。
- 如果浴缸中有水，先排干。
- 观察并确认气泵在大约30分钟后自动开始运转，进行清洗循环。
- 观察并确认气泵在大约两分钟后自动停止运转。

故障处理表		
现象	原因	处理措施
1. 气泡浴缸不能启动。	A. 气泵未能通电。	A. 启动/重启GFCI或ELCB断路器；检查线路。
	B. 控制面板线路松弛或受损。	B. 检查线路连接。如果需要，更换控制面板线路。
	C. 控制面板不能启动。	C. 检查线路连接。更换控制面板。
	D. 气泵不工作。	D. 更换气泵。
2. 气泵启动，但是很少，甚至没有气泡。	A. 气泵接触不良。	A. 连接气泵和气管道
	B. 气泵气管道堵塞。	B. 将气泵周围清理干净。确保足够的通风。
3. 18分钟以前浴缸自动停止运转。	A. GFCI或ELCB故障。	A. 找到故障原因并排除。
	B. 气泵过热，保护装置启动。	B. 检查气泵通风口是否堵塞。移走堵塞物，并让气泵冷却。
4. 22分钟以后浴缸没有自动停止运转。	A. 气泵不工作。	A. 更换气泵。
5. 摁下控制面板上的电源按钮后，气泵不停止运转。	A. 控制面板电线松弛或受损。	A. 检查线路连接，如果必要，更换控制面板电线。
	B. 控制面板不工作。	B. 更换控制面板。
6. 气泵运转，但是各种速度没有差别。	A. 控制面板电线松弛或受损。	A. 检查线路连接，如果必要，更换控制面板电线。
	B. 控制面板不工作。	B. 更换控制面板。
7. 不能进行自动清洗循环。	A. 气泵不工作。	A. 更换气泵。
8. 不能进行手动清洗循环。	A. 控制面板电线松弛或受损。	A. 检查线路连接。如果必要，更换控制面板电线。
	B. 控制面板不工作。	B. 更换控制面板。
	C. 气泵不工作。	C. 更换气泵。

重要的用户资料

用户的责任

请确认泡泡浴缸按照本安装说明书的要求被安装。

按摩系统至少每个月使用一次，以避免电气零件因过度受潮而导致损坏的可能。

清洗亚克力表面：请勿在亚克力表面使用磨损性的清洁用具，以免擦伤浴缸表面，使其失去光泽。每次使用后，将浴缸擦干，以防止肥皂和污垢沉积。

若亚克力表面失去光泽，先用汽车抛光剂*，然后再用粗腊打亮。

*我们推荐使用以下2种抛光剂：

- ① Mequiars 镜面光亮28金属上光剂。(进口)
- ② 抛光膏(绿油)。