

FINISHED WALL/BACK SPLASH  
完工墙面 / 后防溅挡板

NOTE: BEFORE CUTTING COUNTERTOP ALLOW FOR HANDLE CLEARANCE.  
注意: 切割台面前, 请预留龙头把手的操作距离。

51mm Min.  
至少为51mm

OF FITTING

龙头中心线

64mm

# K-2882T VERTICYL™ 维克



## VITREOUS CHINA RECTANGULAR UNDERCOUNTER LAVATORY 釉面陶瓷长方形台下脸盆 CUT-OUT TEMPLATE / INSTALLATION INSTRUCTIONS 切割图/安装说明书

### BEFORE YOU BEGIN

- Due to the nature of the installation, undercounter lavatories should be installed by trained and experienced installers.
- Do not use adhesives or adhesive sealants between marble countertop and lavatory.
- Inspect the waste and supply tubing; replace if necessary.
- Prior to installation, unpack the new lavatory and inspect it for damage. Return the lavatory its protective carton until you are ready to install it.
- Observe all local plumbing and building codes.
- Kohler lavatory is made according to American National Standard that it can match the American lavatory fittings. Any other lavatory fittings may not fit for kohler lavatory.
- The product conforms to GB/T 6952-2015, ASME A112.19.2-2013 and CSA B45.1-08. Please choose faucets that accord with these standards. Kohler faucets are recommended.

### 安装之前

- 有关安装属专业性质的, 故盥洗台下脸盆必须由受过训练及有经验的技师进行安装。
- 切勿在台盆与大理石之间使用胶黏剂或有黏性的密封胶。
- 检查出水及供水管道, 如有需要便更换。
- 安装之前先开启新脸盆的包装, 检查有无损毁后放回纸箱中以免损坏, 到准备安装时才取用。
- 遵守当地所有给排水及建筑规定。
- Kohler lavatory is made according to American National Standard that it can match the American lavatory fittings. 其它洗脸盆配件可能与之不相配。
- 本产品符合中国国家标准GB/T 6952-2015及美国/加拿大标准ASME A112.19.2-2013/CSA B45.1-08, 请选择符合上述标准的龙头, 推荐使用科勒公司龙头。

### INSTALL THE LAVATORY

- Check the desired lavatory location for clearance between the backsplash, faucet, fixture, and cabinet.
- Cut out the template.
- Carefully position and trace the template on the countertop as directed on the template.
- Mark the faucet hole centerline on the countertop.
- Drill a 1/2" pilot hole on the inside of the cut line.
- Cut out the countertop opening with a saber or keyhole saw.

### 安装脸盆

- 检查准备装上面盆的位置, 是否与后挡板、水龙头、脸盆及柜子保持足够的距离。
- 剪出模板。
- 将模板小心放置于盥洗台上, 并在台面上按照模板画出其边缘轮廓导线。
- 在盥洗台上标出水龙头孔位的中心线。
- 在切线内侧钻一个12mm的导孔。
- 用手提电锯或匙孔线锯切开盥洗台。

### FOR WOOD COUNTERTOPS

- Mark and pre-drill the wood screw holes at the locations shown on the template.
- Waterproof any exposed areas of wood.

### 木制盥洗台

- 按照模板所示的位置, 在台面上标出及预先钻穿木螺钉的位置。
- 其他外露的木表面需保持防水。

### FOR MARBLE COUNTERTOPS

- Clean the countertop and block. Keep them dry.

### 大理石盥洗台

- 清洁台面和定位块, 并保持干燥。

### TOOLS AND MATERIALS (Not Supplied)

- Sealant
- Pencil
- Tape measure
- Sharp knife or scissors
- Keyhole or saber saw
- Drill (1/2" dia. drill bit or larger)
- Safety glasses
- Hammer
- Rags or paper toweling
- Strong AB sealant

### 所需工具及物料 (不随货供应)

- 密封胶
- 炭笔
- 卷尺
- 尖刀或剪刀
- 匙孔线锯或手提电锯
- 钻(直径1/2英寸或更大的钻头)
- 防护眼镜
- 锤子
- 抹布或抹手纸
- 高强度AB胶

NOTE: You may require different, more specialized tools to install this lavatory to countertop materials other than wood or wood composites.

注意: 若盥洗台的物料并非木或木质合成品, 则您可能需要在安装脸盆时使用其他更专门的工具。

### ROUGHING-IN

Reference Value  
参考值

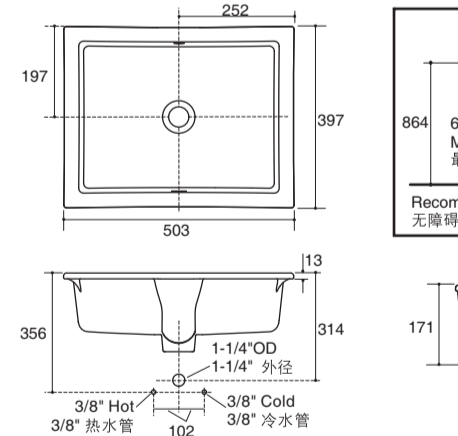

### 尺寸图

Unit:mm  
单位:毫米

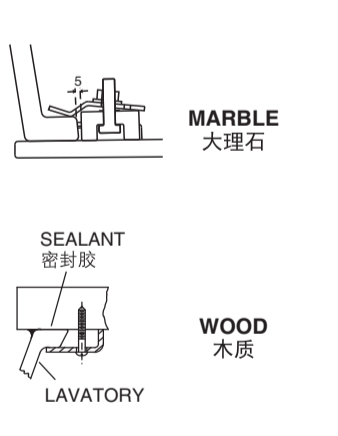
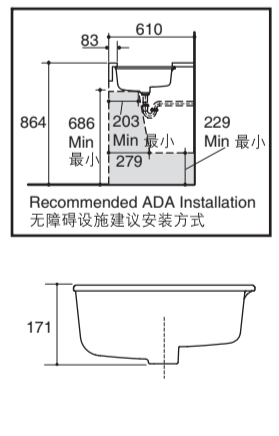

Note: waterproof unprotected overhang area on the underside of wood counter.  
注: 木质盥洗台面板下突出部份需作防水处理。

Kohler reserves the right to change marked dimensions without prior notice.  
科勒公司保留随时变更图中标示尺寸的权利, 无需另行通知。

### CUT ALONG THIS LINE

沿此线切割

### WHEN PLOTTING TEMPLATE FULL SIZE:

Make sure horizontal and vertical dimensions match the dimensions labeled on the template.  
按实际大小标绘切割图时: 确保横向及纵向尺寸与切割图上所标尺寸相符。

RIM OF LAVATORY  
脸盆边缘

432mm

• Keep away from heavy objects within 24 hours.

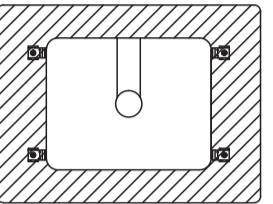

• 24小时内勿承重物。

### FOR ALL INSTALLATIONS

- If the countertop has not been installed, install it at this time.
- Drill the faucet holes according to the faucet installation instructions.
- Install the faucet to the countertop according to the manufacturer's instructions.
- Install the drain to the lavatory according to the manufacturer's instructions.
- NOTE: Please do not use sealant without contractility after drying, such as marble adhesive.
- Apply a continuous bead of quality sealant to the lavatory rim where it will contact the countertop, such as glass cement.

### 所有台面的安装

- 如还未安装盥洗台, 请在这时装上。
- 按照龙头安装说明指引钻龙头孔。
- 按照制造商的说明书, 在盥洗台上装上水龙头。
- 按照制造商的说明书, 在脸盆下装上排水管。
- 注意: 请勿在本品上使用干燥后没有收缩性的胶黏剂, 如云石胶等。
- 在盥洗台接触的脸盆边缘, 如珠串胶涂上优质密封胶, 如玻璃胶等。

### NOTE:

- For marble countertop, use the clamp assembly supplied.
- For countertop made of wood or wood compound (over 25mm thick), purchase clamp assembly 52047.
- For countertop of other materials, use proper clamp assembly by referring to the suggestions on the installation instructions of the countertop manufacturer.

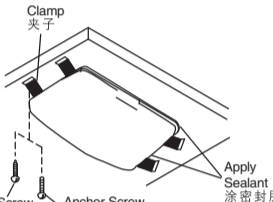

- 大理石材质的盥洗台, 使用随附的夹子组件。
- 木、木质合成物的盥洗台(厚度25毫米以上), 可另行购买夹子组件52047。
- 其它材料制造的盥洗台, 则请参考盥洗台制造商说明书上的建议, 使用适当的扣件。

- Position the lavatory squarely under the cutout before tightening the clamps. Draw the lavatory rim up to the countertop until it is snug. **Do not over-tighten.**
- Immediately wipe away any excess sealant.
- Make the final drain and faucet connection to complete the lavatory installation. Be sure to follow all instructions packed with the drain and faucet.
- Clean up with a **non-abrasive** cleaner.

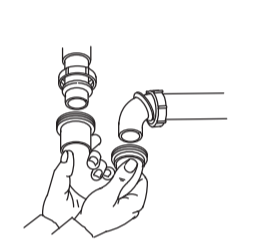

- 在上紧夹具前, 先将脸盆平整地放在盥洗台切口下, 然后小心将脸盆拉直直至台面才可上夹具, 切勿上得太紧。
- 立即擦去多余的密封胶。
- 最后将所有水管及水龙头与脸盆连接妥当, 确保安装乃符合水管及水龙头的一切有关的安装说明书。
- 使用非摩擦性的清洁剂进行清洁。

### CARE AND CLEANING

To keep your lavatory looking new, make sure you rinse it out thoroughly after each use. **DO NOT USE ABRASIVES** on this product, as they will scratch and ruin the surface. Stubborn stains, paint, or tar can be removed with turpentine or paint thinner.

### 护理和清洁

为保持脸盆光洁如新, 须确保每次使用后彻底冲洗干净, 切勿使用腐蚀性的清洁剂, 以免刮花及破坏脸盆的表面, 要清除顽固污垢, 油漆或柏油, 可使用松油或油漆稀释剂。

Do not use the product in the water below 0°C. **CAUTION:** Please do not use hard materials (like scouring pad) to clean product surface, especially the product logo.

不要在0°C以下的水环境中使用。警告: 请勿使用钢丝球等硬质材料擦洗产品表面, 特别是产品商标处。

### SERVICE PARTS

### 维修零件

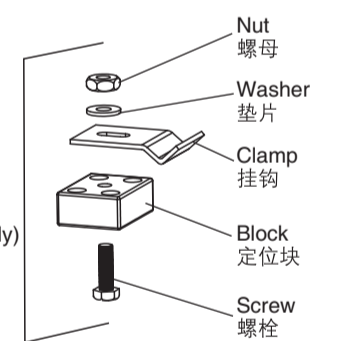

1321585  
Clamp Accessory Pack  
夹子组件  
(For Marble Countertop Only)  
(仅适用于大理石台面)

NOTE: Please purchase clamp accessory pack 52047 for wooden countertop. 注意: 如为木质台面, 请另行购买夹子组件52047。

### BLOCK

定位块

### CLIP LOCATIONS

夹子位置

### IMPORTANT:

For wooden countertop, basin clamp assembly 52047 purchased can only be used on countertops with a minimum thickness of 1". Installer must supply anchors for thinner countertops.

### 重要:

对于木质台面, 另购的52047夹子组件仅可用于厚度最少为25mm的台面, 如果台面较薄, 请另外使用膨胀螺栓固定。