

Features

- Full-length exterior integrated handle
- Tempered glass ensures enhanced safety and durability
- SealNetik™ full-length magnetic seal keeps door firmly closed, providing excellent water containment
- Smooth, easy-to-clean wall jambs
- Pivot shower door configuration consists of one moving panel and one stationary panel

Material

- Framed, 1/8" (3 mm) thick Clear tempered glass
- Anodized aluminum prevents rust and corrosion

Installation

- Fits opening widths 56-5/8" – 59-1/2" (1438 – 1511 mm)
- 72" (1829 mm) high, with 71" (1803 mm) minimum head clearance
- 2-7/8" (73 mm) width adjustment
- 1/2" (13 mm) out-of-plumb adjustability on each side simplifies installation
- Exclusive four-way pivot door design features reversible door and stationary panel and allows door hinges to be positioned either along stationary panel or on outside edge along wall



Codes/Standards

ANSI Z97.1
CAN/CGSB-12.1
CPSC 16CFR 1201

STERLING® One-Year Limited Warranty

See website for detailed warranty information.

Available Colors/Finishes

Color tiles intended for reference only.

Color	Code	Description
	SH	Bright Silver
	BL	Matte Black
	N	Nickel

Available Glass Options

Code	Description
G05	Clear

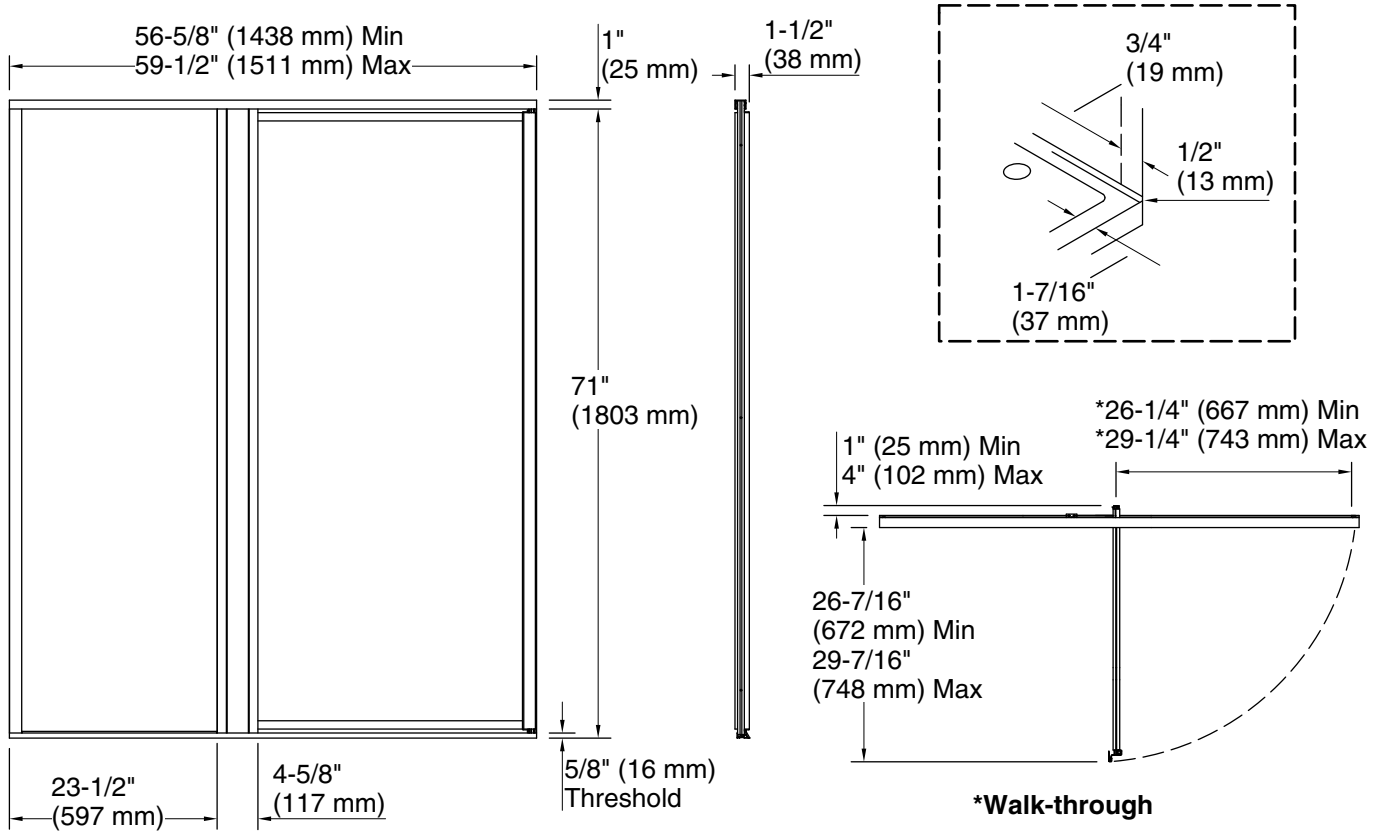

Technical Information

All product dimensions are nominal.

- Base-To-Wall 1/2" (13 mm)
- Radius – Max:
- Shower Ledge Min 1-7/16" (37 mm)
- Flat:
- Shower Wall Min 7/8" (22 mm)
- Flat:

Notes

Install this product according to the installation guide.

The vertical opening should be a minimum of 75" (1905 mm) to allow for installation clearance.