

BEFORE YOU BEGIN

- Please read these instructions carefully to familiarize yourself with the required tools, materials, and installation sequences. Follow the sections that pertain to your particular installation. This will help you avoid costly mistakes. In addition to proper installation, read all operating and safety instructions.
- All information in these instructions is based upon the latest product information available at the time of publication. Kohler China reserves the right to make changes in product characteristics, packaging, or availability at any time without notice.
- These instructions contain important care, cleaning, and warranty information - **please leave instructions for the consumer.**

安装之前

- 请小心详阅本指引。以便熟悉所需工具、材料及安装程序。请遵照适用的章节来安装你的座便器，以避免由于安装不当而导致不必要的损失。除了有关正确的安装方法之外，还务请详阅所有操作及安全指引。
- 本指引所载之一切资料，均以印刷时所有之最新产品情况为基础，科勒中国保留权利随时更改产品特性、包装或供应情况，恕不另行通知。
- 本指引也包含了有关护理、清洁及保养等重要资料 - 请交予用户保存。

ORDERING INFORMATION

SAN RAPHAEL "INGENIUM" Toilet	K-3384K-2
Includes French Curve® Toilet Seat	K-4653T
SAN RAPHAEL "INGENIUM" Toilet	K-3384K-S2
Includes CACHET™ Quiet-Close Toilet Seat	K-4636T-U
SAN RAPHAEL "INGENIUM" Toilet	K-3384K-C2
Includes French Curve® Quiet-Close Toilet Seat ...	K-4713T

订购资料

圣拉菲尔“静漩”超级版座便器	K-3384K-2
含法弧加长型座便器盖板	K-4653T
圣拉菲尔“静漩”超级版座便器	K-3384K-S2
含凯诗抗刮擦缓降座便器盖板	K-4636T-U
圣拉菲尔“静漩”超级版座便器	K-3384K-C2
含法弧型缓降座便器盖板	K-4713T

NOTES

- Observe all local plumbing and building codes.
- Shut off the water supply.
- Seat post holes are on 140mm (5-1/2") centers.
- 51mm (2") passageway.
- Water depth from the rim is 139mm (5-1/2") .
- Ensure that the new drain has the correct roughing-in dimension. This toilet has a 305mm (12") roughing-in dimension. **See Fig. #1.**
- Closet flange must be 305mm (12") on-center from wall.
- Carefully inspect the new fixture for any sign of damage.
- For new construction, refer to the dimensions in **Fig. #1 and Fig. #4** for locating the shut-off valve.
- Fixture dimensions are nominal and conform to tolerances established by ASME Standards (A112.19.2-2008).

 **WARNING: Risk of personal injury or product damage:** Handle vitreous china products very carefully. Vitreous china can break and chip if you overtighten bolts and nuts.

 **WARNING: Risk of external leakage.** The fill valve nut has been factory-tightened to design specifications. If re-tightening is required, wrench tighten one turn past finger tight .

注意

- 遵守当地所有给排水及建筑规定。
- 先关掉水源。
- 盖板孔中心间距140mm。
- 51mm排污通道。
- 座便器上表面距水面139mm。
- 请确保污水管的坑距尺寸正确。本型号坑距为305mm(请参阅图1)。
- 座便器法兰盘中心必须距离墙壁305mm。
- 小心检验新的座便器是否有损坏的迹象。
- 若为新安装工程，请参看图1及图4的尺寸指示以找出止水阀。
- 部件尺寸为标定值，误差符合美国ASME标准A112.19.2-2008。

 **警告：**提防身体受伤或产品破裂。请小心处理釉面陶瓷产品。不可把螺母和螺栓上得过紧，以免产品破损或崩裂。

 **警告：**有向外渗漏之危险。注水阀螺母在出厂时已上紧以符合设计规格，如需再上紧，可用手上紧后再以板钳上紧一圈。

TOOLS AND MATERIALS REQUIRED (Not supplied)

所需工具及材料 (不随货供应)

- 254mm (10") adjustable wrench
- 305mm (12") pipe wrench
- Metal file (file cut)
- Tape measure
- Tubing cutter
- Level
- Hacksaw
- Putty knife
- Screwdriver
- Toilet gasket (wax seal)
- Toilet installation flange
- Toilet T-bolts (2), 8mm (5/16") diameter
- Supply hose, at least 300mm recommended
- Toilet supply shut-off valve, 10mm(3/8") recommended

- 254mm 活动板钳
- 305mm 喉管板钳
- 锉刀
- 卷尺
- 切管刀
- 水平尺
- 钢锯
- 涂油灰刀
- 螺丝刀
- 座便器垫圈 (蜡封)
- 安装座便器用之法兰盘
- 直径8mm的T型螺栓 (2枚)
- 供水软管, 建议长度不小于300mm
- 座便器供水管止水阀, 以10mm为准

NOTICE: If the existing toilet does not have a supply shut-off valve below the tank, install one before installing the new toilet.

注意: 如果现有座便器的水箱下方没有止水阀, 须在安装新座便器前装妥止水阀。

ROUGHING-IN

尺寸图

Reference Value
参考值

Unit: mm
单位: 毫米

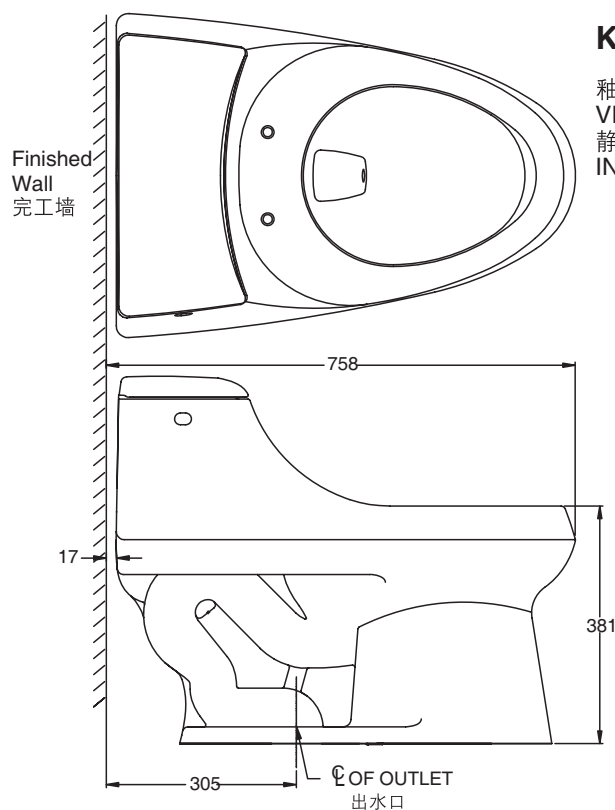

K-3384K-2/K-3384K-S2/K-3384K-C2

釉面陶瓷连体座便器
VITREOUS CHINA ONE-PIECE TOILET
静漩冲水系统
INGENIUM FLUSHING SYSTEM

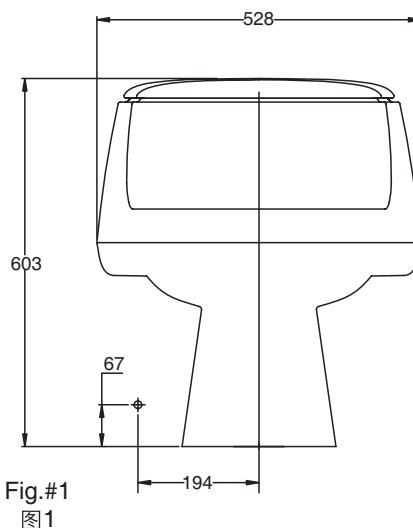

FRONT OF BOWL
缸体前端

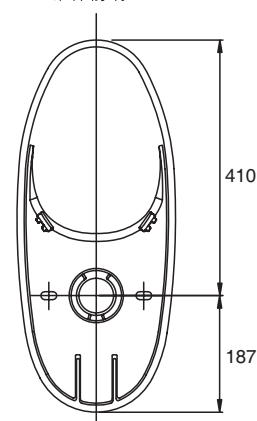

Fig.#1
图1

科勒公司保留随时变更图中标示尺寸的权利, 无需另行通知。
Kohler reserves the right to change marked dimensions without prior notice.

INSTALLATION

安装

TO REMOVE EXISTING TOILET

拆除旧座便器

Turn off the water supply. Flush the toilet, and use a sponge to remove the remaining water from the tank and bowl. Disconnect the supply shut-off valve (if present), and remove the old tank and bowl.

关掉供水源, 给座便器冲水, 用海绵吸去座便器内的剩余水份, 除下供水管止水阀(如果有), 移开旧水箱和座便器。

Remove the old gasket from the floor and the closet flange with a putty knife. Remove the old T-bolts and discard them.

NOTICE: if the new toilet is not installed immediately, temporarily stuff a rag into the closet flange.

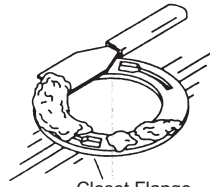

Fig.#2
图2

用涂油灰刀拆除地上的旧密封垫圈及座便器法兰盘，拆除及扔掉旧的T型螺栓。

注意：如果不能即时安装新座便器，请用碎布暂将法兰盘堵住。

Install two new 8mm (5/16") diameter T-bolts into the closet flange.

NOTICE: Do not use white cement or high lime content cements to install this toilet. The expansion of cement due to a rise in temperature may make the toilet crack or cause damage. Kohler is not responsible for any damage caused by installation with the use of cement.

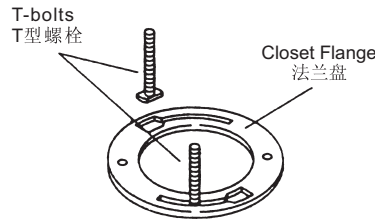

Fig.#3
图3

安装两枚直径8mm的新T型螺栓在法兰盘上。

注意：安装本座便器时切勿使用白水泥或高石灰含量之水泥，因水泥的热膨胀可能使座便器的脚部挤破或损坏。科勒对所有因水泥安装而引致的座便器破裂恕不负责。

TO INSTALL SUPPLY SHUT-OFF VALVE

Install the supply shut-off valve so it is 67mm (2-5/8") above the finished floor line, and 194mm (7-5/8") to the left of the closet flange centerline.

The centerline of the supply shut-off valve outlet should extend 67mm (2-5/8") from the finished wall. Install the supply shut-off valve with the outlet vertical.

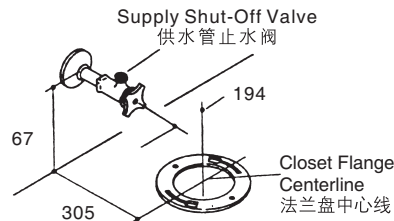

Fig.#4
图4

安装供水管止水阀

安装厕所供水管止水阀，使之离地线67mm，也离法兰盘中心线左面194mm。

供水管止水出口管应凸出完工墙67mm；安装止水阀应以出口管垂直为合。

TO INSTALL BOWL

Set the bowl upside down on some padding. Firmly press the toilet gasket onto the toilet outlet.

NOTE 1: Wax ring type toilet gasket should not be installed at temperatures less than 21°C.

NOTE 2: If you are using a toilet gasket with an integral plastic sleeve, make sure the gasket is positioned with the sleeve facing away from the toilet.

If you temporarily plugged the closet flange with a rag, remove the rag at this time and ensure that the drain pipe is clear and free of debris.

Carefully align and lower the bowl over the closet flange and T-bolts. Apply full body weight to the bowl rim to set the seal.

CAUTION: Risk of concealed leakage: Do not lift or rock the bowl after placement - a new toilet gasket must be installed if you break the watertight seal.

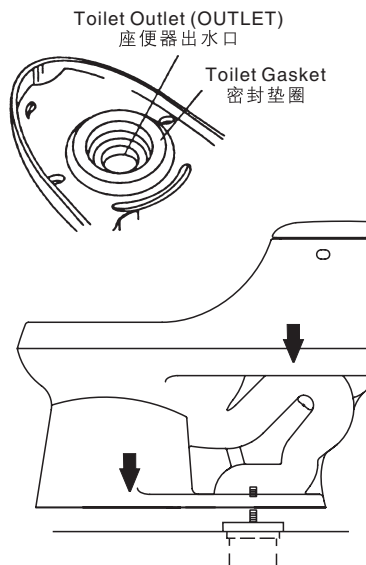

Fig.#5
图5

安装座便器

将新的座便器倒置于垫上，将密封垫圈紧套于座便器出水口。

注意1：如使用蜡封式密封垫圈，室温不应低于摄氏度21°C。

注意2：如所使用的密封垫圈附有内式塑料套，则此垫应朝外放置。

若曾将碎布放在法兰盘内，请先将碎布取出，确保污水管清洁，无碎屑阻塞。

小心对准并将座便器放置在法兰盘及螺栓上，再将全身重量向下压在座便器边缘上以固定封口。为了要达到最佳的效果，请在安装时确定座便器是否水平。

警告：有隐蔽渗漏之危险。放好座便器后，不可再提起或摇动；如密封垫之防水效果受到破坏，必须更换新的密封垫圈。

Assemble the bolt cap bases, washer, and nuts on the exposed T-bolts. Handtighten the nuts, then tighten them an additional 1/2-turn.

CAUTION: Risk of personal injury or product damage. Overtightening may cause breakage or chipping of the vitreous china.

If the T-bolts extend more than 6mm (1/4") over the top of the nuts, cut off the excess and file the end. Wipe away any residue. Install the bolt caps.

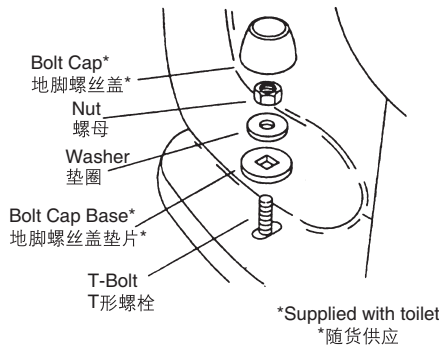

Fig.#6
图6

将地脚螺丝盖垫片、垫圈和螺母套在外露的T型螺栓上，用手上紧所有螺母，再用扳钳额外上紧半圈。

警告：提防身体受伤或产品破裂。螺母不可上得太紧，否则会导致釉面陶瓷损坏及崩裂。

如T型螺栓露出超过6mm时，切掉过长者并锉平末端，然后抹去碎屑，安装地脚螺丝盖。

TO CONNECT WATER SUPPLY

* Flexible hose (not provided) are recommended to connect the supply line to the fill valve. If you use a rigid connection(not provided), take care not to apply side forces to the bottom of the fill valve. Be sure the rigid connection must be fit with supply line completely to prevent damage shank by forced connection.

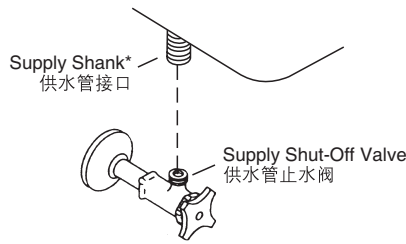

Fig.#7
图7

连接供水管止水阀

我们建议使用软管(不随货供应)来连接供水管与座便器进水阀。如果您使用硬管(不随货供应)连接的话，连接时要注意不要在进水阀的底部施加横向压力，并注意硬管必须与供阀口完全吻合，以免强行连接日后会损坏接口。

IMPORTANT: Before turning on the supply valve for the first time, follow the steps below to clear sand, debris and rust from the system:

注意：第一次打开供水阀之前，请按下列步骤清理阀门组件里的砂石、碎屑及铁锈：

Make sure water supply is off. Remove valve END by rotating it 1/8 turn counterclockwise.

关掉供水源，以逆时针方向旋转1/8圈，拆除阀帽。

While holding a container over the uncapped VALVE to prevent splashing, turn water supply on and off a few times. Leave water supply off.

用杯子盖好无遮盖的阀门组件以防溅水，然后反覆开关水源数次，最后关掉水源。

Replace END by engaging lugs and rotating 1/8 turn clockwise. **Make certain the top is turned to the locked position. Valve may not turn on if top is not fully in the locked position.**

重新盖上阀顶部份，顺时针旋转阀帽1/8圈上好，阀帽必须旋转至对准上锁的位置，否则可能无法打开注水阀。

Turn on water supply. Check that water level is at the marked water line.

打开水源，查核水位是否达到水位线。

Attach the toilet seat according to the installation instructions included.

依照有关安装指示安装座便器盖板。

Open the supply shut-off valve and check all connections for leakage. If the connections have been properly assembled, a slight retightening of the nuts should stop any leakage.

打开供水管止水阀检查所有接口有无渗漏情况，如果接口均安装妥当，将螺母略微旋紧即可防漏。



Fig.#8
图8

FILL FLOAT WITH BALLAST

注水以稳定浮球

Adjust the float by the cross-shaped thread and sliding it up or down on the float rod until the water level is at the marked water line.

可调节浮杆螺纹，向上或下调整浮球直至水位达到水位线。

Test flush the toilet.

测试冲水情况。

Check all connections for leakage for several days.

安装后的几天内，应反复检查所有接口有无渗漏。

Set the tank cover in place on the tank.

盖上水箱盖。

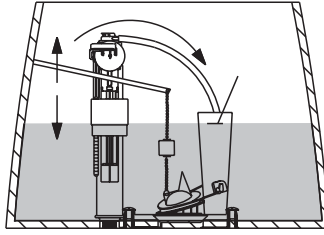

Fig. #9
图9

TROUBLESHOOTING CHART

SYMPTOMS	PROBABLE CAUSES	CORRECTIVE ACTION
1. Fill valve turns on/off by itself without toilet being flushed.	<ul style="list-style-type: none"> A. No slack in flapper chain assembly, holding flapper off seat. B. Flush valve flapper ball worn, dirty or misaligned with flush valve seat; or seat corroded so flapper will not seal. 	<ul style="list-style-type: none"> A. Adjust flapper chain assembly for proper slack. B. Inspect, clean and, if necessary, replace flapper ball and/or seat.
2. Fill valve continues to run, allowing water to enter tank.	<ul style="list-style-type: none"> A. Foreign particles lodged under the float valve seal (located under fill valve cap). B. Fill valve seal (located under float valve cap) may be cracked or split. C. Tank water level set above overflow level. D. Water leaking past flush ball. E. Trip lever binding, holding flush ball open. 	<ul style="list-style-type: none"> A. Shut off water supply; remove fill valve cap assembly by rotating 1/8 turn counterclockwise. Cover uncapped lower valve unit with an inverted cup (holding it to prevent overspray), and turn water on and off a few times. Clean fill valve seal surface (located under float valve cap). Replace fill valve cap assembly by engaging lugs and rotating 1/8 turn clockwise. Turn water on. Install filter in supply line to prevent recurring problems. B. Replace seal. C. During fill cycle, hold float under water a few seconds to allow it to fill with water ballast. Adjust float by adjust the cross-shaped thread on float rod and sliding float up or down on float rod until water level is at marked water line. D. Replace flush ball. E. Turn trip lever nut clockwise to loosen until trip lever no longer binds.
3. Incorrect water level height.	<ul style="list-style-type: none"> A. Valve float cup does not contain enough water to provide required ballast. B. Float height incorrect. 	<ul style="list-style-type: none"> A. During fill cycle, hold float under water a few seconds to allow it to fill with water ballast. B. Adjust the cross-shaped thread on float rod until water level is at marked water line.
4. Long or noisy tank fill cycle.	<ul style="list-style-type: none"> A. Plugged valve inlet or supply line. 	<ul style="list-style-type: none"> A. Perform Corrective Action 2.A.
5. Poor flush.	<ul style="list-style-type: none"> A. Water level is too low. B. Trapway or rim holes are obstructed. C. Soil pipe or vent is obstructed. D. Supply shut-off valve not fully open. 	<ul style="list-style-type: none"> A. Adjust tank water level. B. Unclog trapway; clean rim holes. C. Clear obstruction from soil pipe or vent. D. Open supply shut-off valve.
6. Toilet overflows.	<ul style="list-style-type: none"> A. Toilet trapway is obstructed. B. Soil pipe or vent is obstructed. 	<ul style="list-style-type: none"> A. Use plunger to unclog. B. Clear obstruction from soil pipe or vent pipe.
7. Toilet does not activate.	<ul style="list-style-type: none"> A. Chain is not connected to lift rod or flush valve. 	<ul style="list-style-type: none"> A. Reconnect the chain.

故障处理表

现象	原因	处理措施
1. 未冲水浮球阀已自行开/关	A. 橡胶盖链组合调校过紧, 令橡胶盖抽离阀座。 B. 冲水阀的橡胶盖球磨损、肮脏或与冲水阀座的位置不配合; 或阀座磨缺后, 令橡胶盖不能合起来。	A. 调节橡胶盖链组合以达致合适的松缓程度。 B. 检查清楚及进行清洁, 如有需要更换橡胶盖球及/或阀座。
2. 浮球阀转不停, 水不断溢入水箱	A. 浮球阀密封圈下面有外来物卡住(在浮球阀帽下)。 B. 浮球阀密封圈(在浮球阀帽下)可能已破裂。 C. 水箱的水位线高度高于溢水线。 D. 冲水阀球渗漏。 E. 冲水把手太紧, 固定了浮球在开启的位置。	A. 关掉供水管, 以逆时针方向把浮球阀帽组合旋1/8圈即可拆除, 用杯子盖好无遮盖的阀门组件(紧盖着以防洒水四溅), 反覆开关水源数次。清洁浮球阀密封圈的表面(在浮球阀帽下)。盖上阀帽组件, 顺时针旋1/8圈上好, 打开供水开关。在供水系统上安装过滤装置, 可防止问题再次发生。 B. 更换密封圈。 C. 在水箱注水时, 把浮球按在水中数秒, 使其注够水份稳定下来, 要调整浮球高度, 只需调整浮杆上的十字螺纹, 直至水位处于水位线上。 D. 更换冲水阀球。 E. 顺时针松开冲水把手的螺母, 直至冲水把手松紧适中。
3. 水位线高度不正确	A. 阀门浮杯内装水不足以使其稳定。 B. 浮球高度不正确。	A. 在水箱注水时, 把浮球按在水中数秒, 使其注够水份稳定下来。 B. 要调整浮球杆高度, 只需调整浮球杆上的十字螺纹, 直至水位处于水位线上。
4. 水箱注水需时过长或噪音过大	A. 阀门入水口或供水管堵塞。	A. 按2A措施处理。
5. 冲水不灵	A. 水位太低。 B. 座便器排污管或冲水孔堵塞。 C. 污水管或通道堵塞。 D. 供水管止水阀未完全打开。	A. 调校水箱水位。 B. 通开冲水道及清洁喉面孔。 C. 清除污水管或通道的堵塞物。 D. 打开供水管止水阀。
6. 厕所溢水	A. 排污管堵塞。 B. 污水管或通道堵塞。	A. 用通渠泵清理排污管。 B. 清除污水管或通道的堵塞物。
7. 冲水掣不灵	A. 链子未能联接冲水杆或冲水阀。	A. 把链子联接好。

CONSUMER RESPONSIBILITIES

If you live in a hard water area, make certain that the holes in the toilet rim are kept clean to ensure proper bowl flushing. Toilet bowl cleaners should be used at least once a week. Use a long-handled brush to clean the rim holes, and to clean as far into the trap as possible to prevent mineral deposits from forming.

Most toilet bowl cleaners are not harmful to the vitreous china surface of the toilet bowl. Please follow the bowl cleaner manufacturer's instructions carefully.

Do not use abrasive cleaners or solvents.

 **WARNING: Risk of property or product damage.**
Do not use in-tank cleaners. Products containing chlorine (calcium hypochlorite) can seriously damage fittings in the tank. This damage can cause leakage and property damage.

Kohler Company shall not be responsible or liable for any damage to these tank fittings caused by the use of cleaners containing chlorine (calcium hypochlorite).

 **CAUTION: Don't use any cement while installing the toilet.** Heat expansion of the toilet may damage the feet of the toilet. Kohler will not be responsible for any damage because of using cement.

 **WARNING: Risk of product damage.**
Do not throw into the toilet what is easy to block it, such as newspaper, paper pilch, sanitary towel. Do not bump the vitreous china with great force to prevent it from damaging and leaking. Do not use the product in the water below 0°C.

 **CAUTION:** Please do not use hard materials (like scouring pad) to clean product surface, especially the product logo.

用户责任

如果你居住地方的水质是硬性，你必须保持冲水孔清洁，令座便器冲水正常。每星期应最少使用座便器清洁剂清洁一次，用长把手的刷子清洁冲水孔，并尽量伸入排污管洗刷，防止矿物质积聚。

大多数马桶清洁剂对座便器表面是无害的。请认真遵循马桶清洁剂制造商的指示来操作。

请勿使用腐蚀性清洁剂或溶剂。

 **警告：提防楼宇受损或损坏产品。** 请勿使用水箱内用清洁剂。含氯（次氯酸钙）的清洁剂会严重破坏水箱配件，从而引起渗漏，或对楼宇结构造成损坏。

科勒公司对此类因使用氯(次氯酸钙)而引致的水箱装置损毁，概不负责。

 **警告：在安装本座便器时切勿使用任何水泥。** 因为水泥的热膨胀可能使座便器的脚部挤破或损坏。科勒对所有因为水泥安装而引起的座便器破裂恕不负责。

 **警告：提防损坏产品。**
请不要向便器内冲入新闻纸、纸尿垫、妇用卫生巾等容易堵塞的物品。
请不要用重力撞击陶瓷，以防止破损漏水。

不要在0°C以下的水环境中使用。

 **警告：请勿使用钢丝球等硬质材料擦洗产品表面，特别是产品商标处。**