

Features

- CleanCoat®+ glass coating creates a hydrophobic barrier that repels water, soap scum, and residue, saving time and protecting shower doors 10 times longer than original CleanCoat. (Based on 2021 internal wear/abrasion testing using a microfiber cloth.)
- Interior and exterior towel bars complete the look of this door
- Tempered glass ensures enhanced safety and durability

Material

- Frameless, 1/4" (6 mm) thick tempered glass
- Anodized aluminum prevents rust and corrosion

Installation

- Out-of-plumb adjustability simplifies installation
- Not for use in hospitality
- For residential use only



Codes/Standards







ANSI Z97.1
CAN/CGSB-12.1
CPSC 16CFR 1201

**STERLING® Bath and Shower Doors
Five-Year Limited Warranty**

See website for detailed warranty information.

Available Colors/Finishes

Color tiles intended for reference only.

Color	Code	Description
	DR	Deep Bronze
	DR	Deep Bronze
	N	Nickel
	N	Nickel
	PBL	Matte Black
	PBL	Matte Black
	S	Silver
	S	Silver

Available Glass Options

Code	Description
G69	Clear Lake Mist™

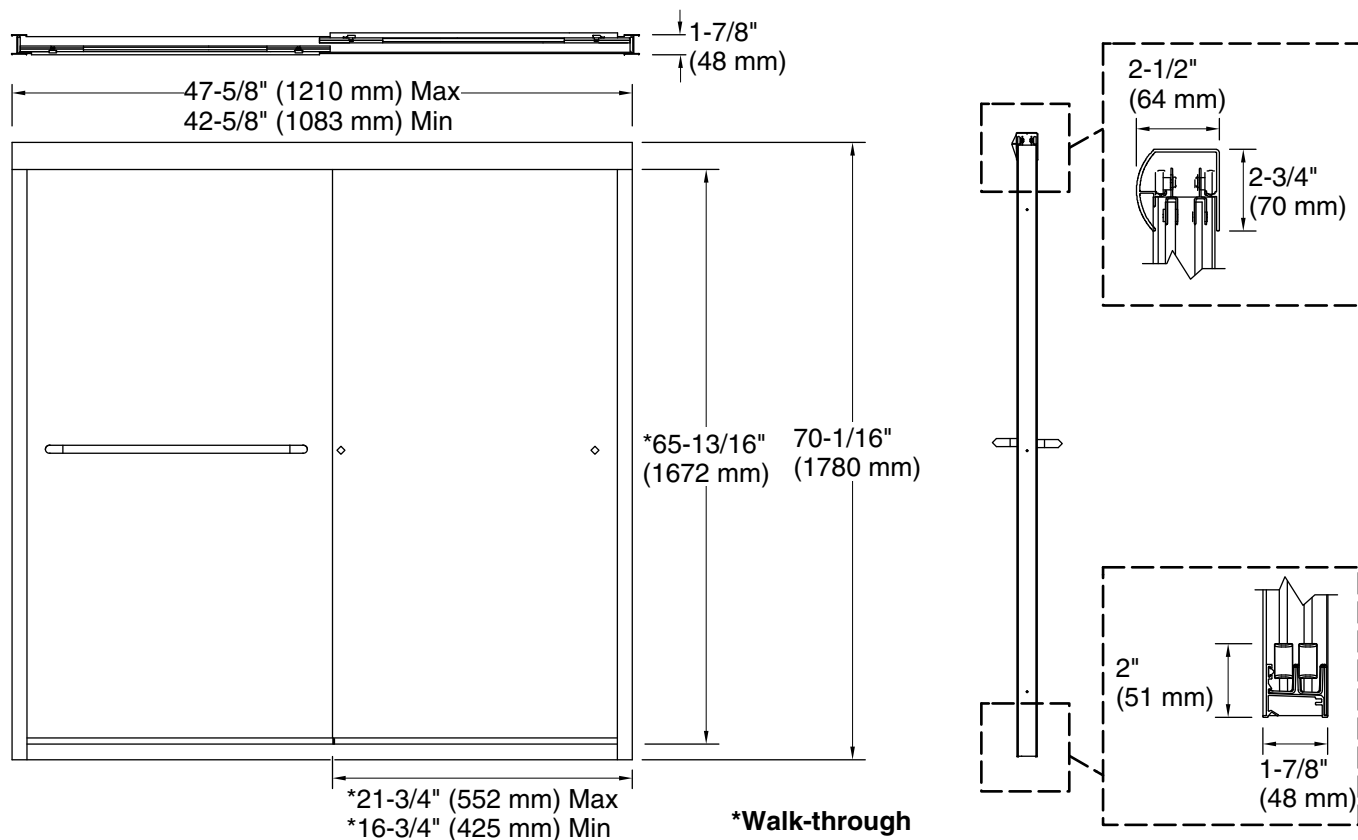

Technical Information

All product dimensions are nominal.

- Base-To-Wall 1/2" (13 mm)
- Radius – Max:
- Shower Ledge Min 2-1/8" (54 mm)
- Flat:
- Shower Wall Min 2-11/16" (68 mm)
- Flat:

Notes

Install this product according to the installation instructions.

The vertical opening should be a minimum of 72-7/16" (1840 mm) to allow for installation clearance.