

Features

- Heavy 1/4" (6 mm) glass for strength and stability
- CleanCoat®+ glass coating creates a hydrophobic barrier that repels water, soap scum, and residue, saving time and protecting shower doors 10 times longer than original CleanCoat. (Based on 2021 internal wear/abrasion testing using a microfiber cloth.)
- Tempered glass ensures enhanced safety and durability

Installation

- Out-of-plumb adjustability simplifies installation
- Door can be installed to open to the left or right to suit your bathroom layout
- Not for use in hospitality
- For residential use only

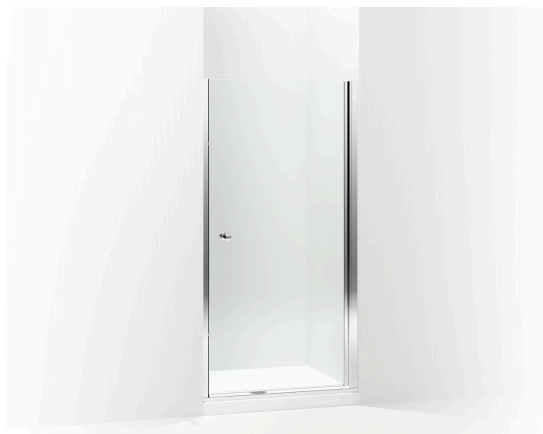

Codes/Standards





ANSI Z97.1
CAN/CGSB-12.1
CPSC 16CFR 1201

**STERLING® Bath and Shower Doors
Five-Year Limited Warranty**

See website for detailed warranty information.

Available Colors/Finishes

Color tiles intended for reference only.

Color	Code	Description
	ADR	Anodized Deep Bronze
	ADR	Anodized Deep Bronze
	N	Nickel
	N	Nickel
	S	Silver
	S	Silver

Available Glass Options

Code	Description
G05	Clear Frosted

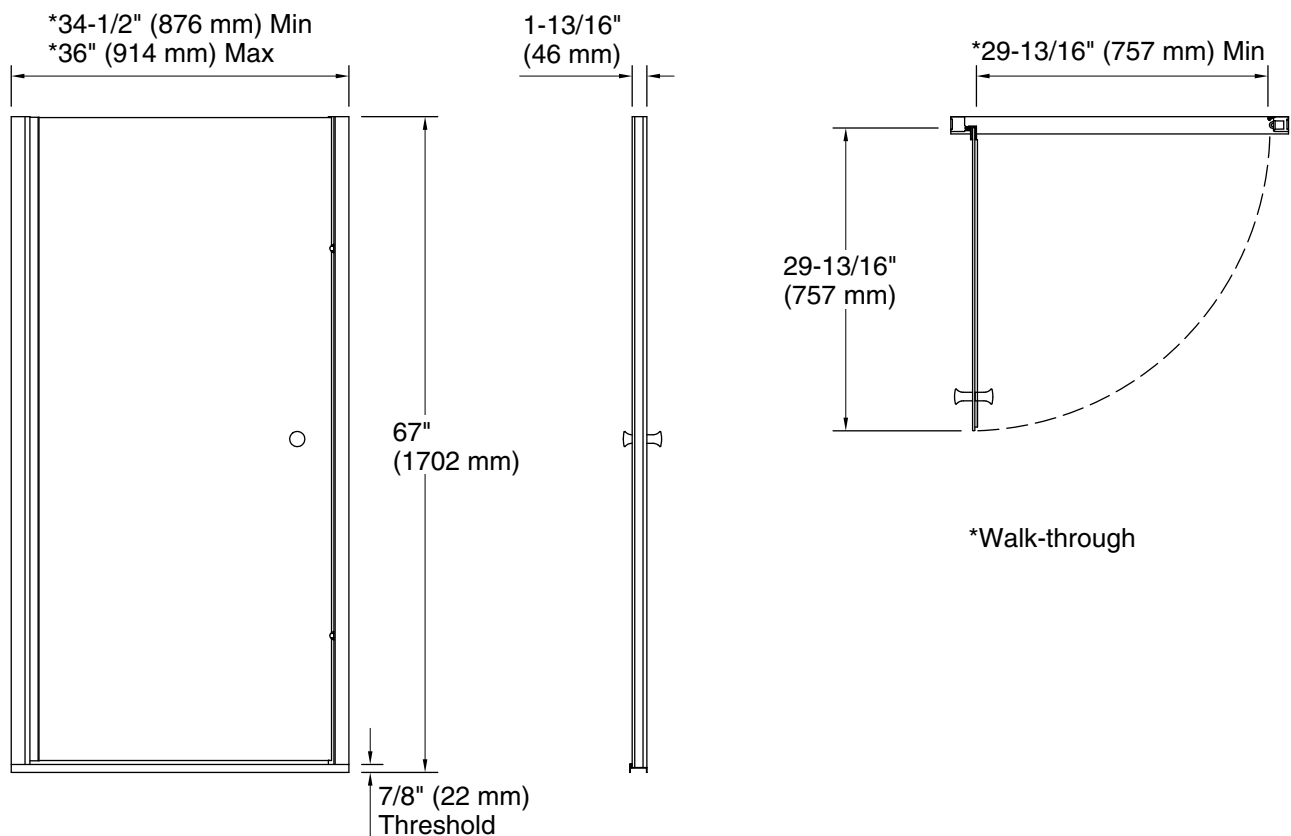

Technical Information

All product dimensions are nominal.

- Base-To-Wall $\frac{1}{2}$ " (13 mm)
- Radius – Max:
- Shower Ledge Min $1\frac{3}{4}$ " (44 mm)
- Flat:
- Shower Wall Min $1\frac{1}{2}$ " (38 mm)
- Flat:

Notes

- Install this product according to the installation instructions.
- The vertical opening should be a minimum of 67" (1702 mm) to allow for installation clearance.