



Performa™ 2

60" x 29" Vikrell® bath, right above-floor drain
71341122



Features

- Durable high-gloss finish
- 17-1/4" (438 mm) bath depth (floor to top of threshold)
- Integral apron creates a clean, finished look
- Innovative 1/2" (12.7 mm) step flange provides superior water containment for installation with tile or Vikrell® wall sets
- Complements traditional and contemporary bathroom designs
- Compatible with 7134 Series Performa 2 wall sets

Material

- Compression-molded from our exclusive solid Vikrell® material

Installation

- Alcove
- Right drain
- Above-floor-drain (AFD) rough-in

Recommended Products/Accessories

K-23726 Drain treatment
71344000 60" x 29" bath/shower wall set



ADA

Codes/Standards

CSA B45.5/IAPMO Z124
ASTM E162
ASTM E662
ADA
ICC/ANSI A117.1

STERLING® Vikrell® or Acrylic Baths and Shower Bases Ten-Year Limited Warranty

See website for detailed warranty information.

Available Colors/Finishes

Color tiles intended for reference only.

Color Code Description

	0	White
--	---	-------

1-800-STERLING (1-800-783-7546)

Kohler Co. reserves the right to make revisions without notice to product specifications.

For the most current Specification Sheet, go to www.sterlingplumbing.com.

3-31-2026 20:15 - US/CA

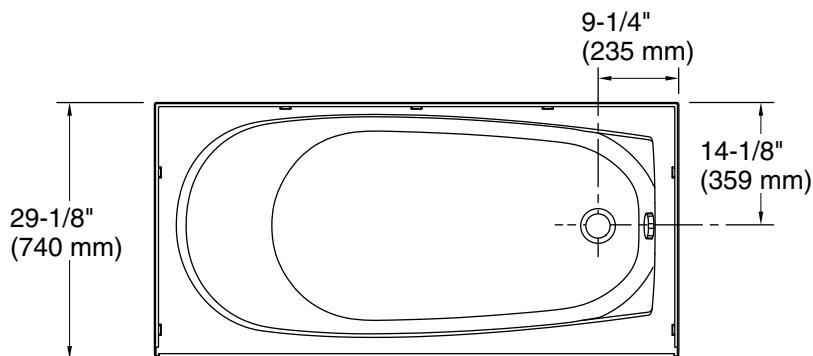

No change in measurements if connected with drain illustrated. (K-7213)

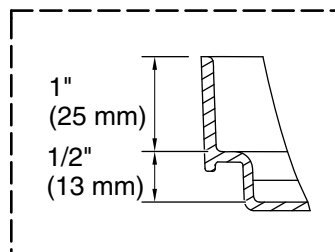

Integral Flange Detail

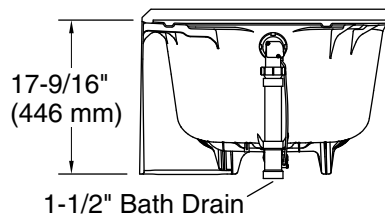
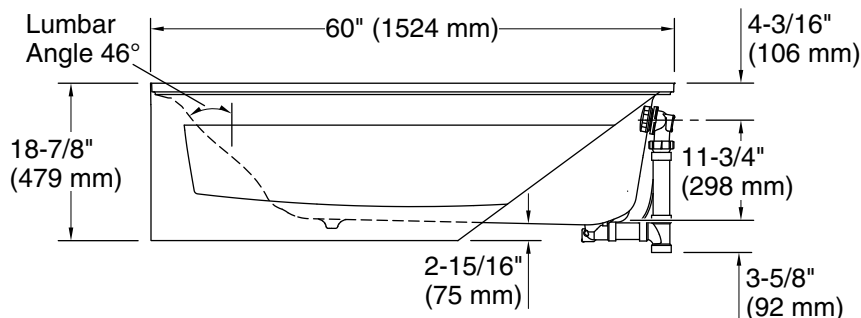

Technical Information

All product dimensions are nominal.

- Drain location: Right
- Basin area, bottom: 39" x 21" (991 mm x 533 mm)
- Basin area, top: 53" x 24" (1346 mm x 610 mm)
- Weight: 47 lbs (21.3 kg)
- Water depth: 9-3/4" (248 mm)
- Water capacity: 35 gal (132.5 L)
- Minimum flat for door: 1-3/4" (44 mm)

Notes

- Install this product according to the installation instructions.
- ADA compliant when installed to the specific requirements of these regulations.