



GUARD+®

60" x 42" Vikrell® shower base, center drain
72391100



Features

- Full-length water-containment guard and 1" (25 mm) weep channels redirect water into the base, providing four-sided water containment
- 3-1/2" (89 mm) threshold
- Durable high-gloss finish
- Textured bottom surface
- Suitable for tile-down applications
- Compatible with STERLING Medley® shower walls

Material

- Made from solid Vikrell® material for strength, durability, and lasting beauty

Installation

- Alcove

Recommended Products/Accessories

- 5475-59 Frameless sliding shower door
- 5970-59 Framed sliding shower door
- 5975-59 Framed sliding shower door
- 5976-59 Framed sliding shower door
- 547808-59 Frameless sliding shower door
- 581075-59 Frameless sliding shower door
- 80001012 12" straight grab bar
- 80001018 18" straight grab bar
- 80001024 24" straight grab bar
- 72186104 Freestanding shower seat
- K-23726 Drain treatment



Codes/Standards

- CSA B45.5/IAPMO Z124
- ASTM E162
- ASTM E662

STERLING® Vikrell® or Acrylic Baths and Shower Bases Ten-Year Limited Warranty

See website for detailed warranty information.

Available Colors/Finishes

Color tiles intended for reference only.

Color Code Description

	0	White
---	---	-------

1-800-STERLING (1-800-783-7546)

Kohler Co. reserves the right to make revisions without notice to product specifications.

For the most current Specification Sheet, go to www.sterlingplumbing.com.

4-4-2026 20:01 - US/CA

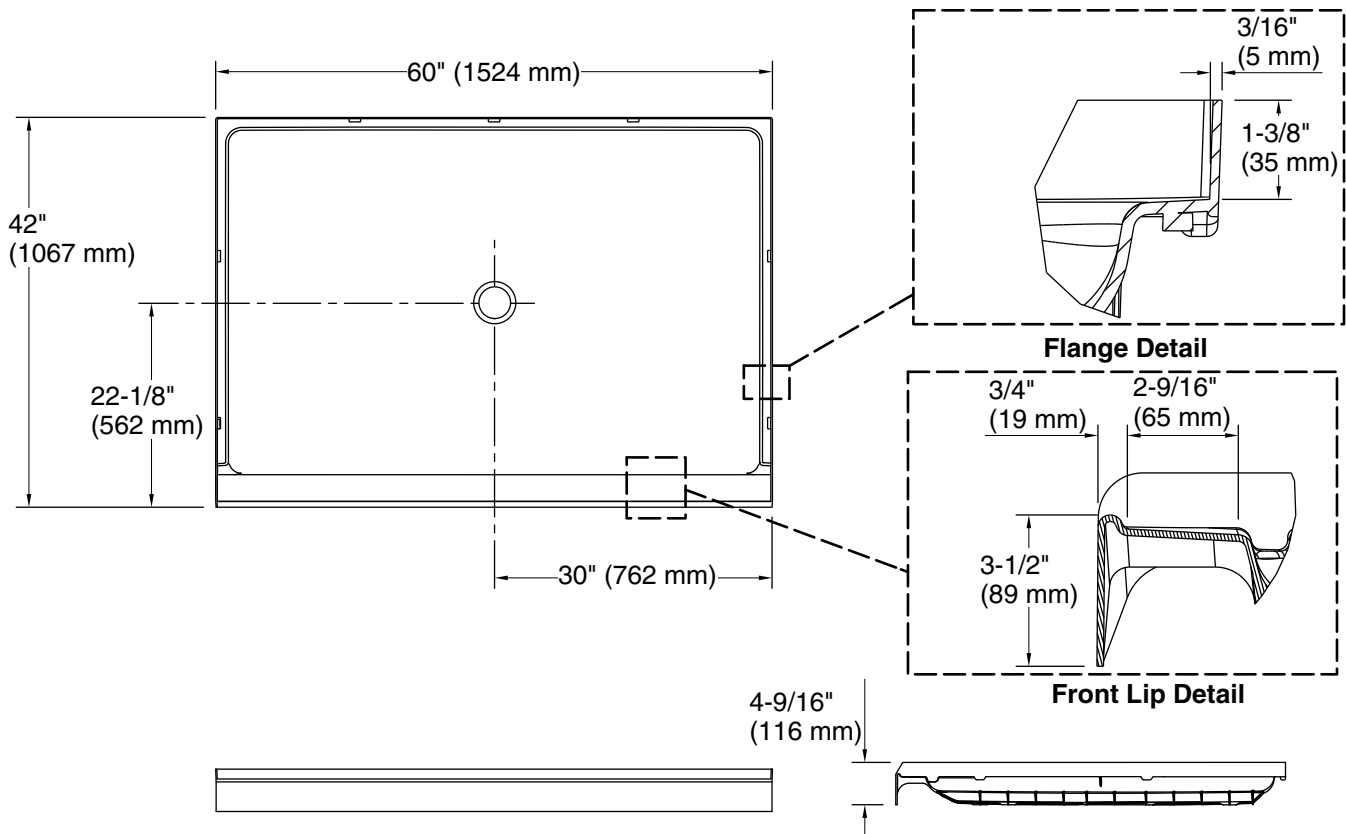

Technical Information

All product dimensions are nominal.

- Drain location: Center
- Weight: 47 lbs (21.3 kg)
- Minimum flat for door: 2-1/2" (64 mm)

Notes

Install this product according to the installation instructions.