

7786T-4 挂墙式浴缸花洒龙头

安装之前

所有的资料是按最新出版的产品资料编写而成。科勒公司保留任何时候不经通知即可改变产品特性、包装或产品可供类型的权利。

说明书包括重要的安装、保养及清洁方面的内容，请把这些资料交给用户阅读。

注意事项：

- 1.一定要先彻底冲洗供水管以清除管道中的杂质。
- 2.切换器正常为 0.05Mpa(0.5bar)。
- 3.花洒最高工作压力:0.5MPa(5 bar)。水压超过 0.5MPa(5 bar)须安装减压阀。花洒最高工作温度及环境温度:60° C。请特别注意花洒须远离浴霸，否则可能损坏花洒，甚至对使用者造成伤害。
- 4.手持花洒限流器不可以取出，否则将损坏花洒。

BEFORE YOU BEGIN

All information is based on the latest product information available at the time of publication. Kohler Co. reserves the right to make changes in product characteristics, packaging, or availability at any time without notice.

Please leave these instructions for the consumer. They contain important information.

NOTES:

- 1.Flush the water supply pipes thoroughly to remove debris.
- 2.The minimum inlet water pressure for the diverter is 0.05Mpa (0.5bar).
- 3.The highest working pressure for handspray is 0.5Mpa(5 bars). If it exceeds 0.5Mpa(5 bars), a pressure reducer is needed. The highest water and environment temperature is 60° C. Please keep handspray away from heater, or maybe damage it and hurt user.
4. Don't remove the regulator, or will damage the handspray.

使用说明

将手柄轻轻提起,向上转为热水,向下转为冷水。

龙头切换器处于正常位置时浴缸出水口出水,下拉切换器切换至手持花洒出水。

HANDLE OPERATION

Lift the handle gently.Turn upwards for hot water. Turn downwards for cold water.

Water flows out from spout when faucet diverter is in the normal position and it's diverted to handspray when the diverter is pulled down.

安装尺寸

ROUGH-IN DIMENSIONS

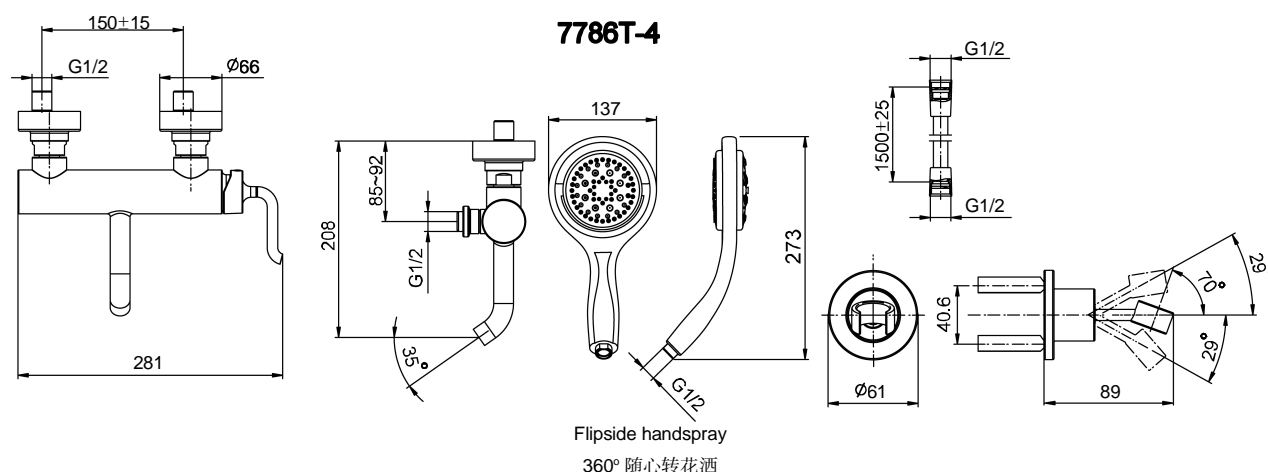

安装说明

为使安装顺利, G1/2" 内螺纹管道配件应已安装好。预留 150mm 的间距, 保持水平, 并垂直墙面, 低于和高出墙面的长度不超过 5mm。热供水管装在左边。

在两个接头(1)涂上螺纹密封或缠绕足以密封的密封胶带, 旋入冷热供水管中。

调节两个接头, 使其中心距离为 150mm 并保持同一水平。它们凸出墙面的尺寸应该在 40 到 47 毫米之间。在装饰罩背面边缘涂一圈油灰, 将装饰罩(2)旋入接头, 紧贴装修后的墙壁。去除多余油灰。

将垫片(3)放入螺母(4)中, 把螺母旋到接头(1)上, 用带状扳手锁紧。

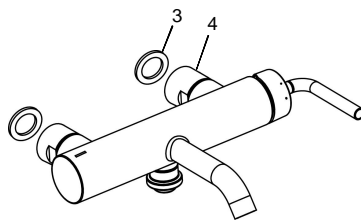
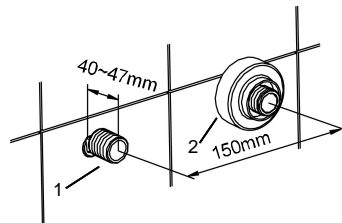
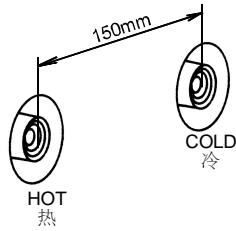

INSTALLATION

To perform installation, installer must provide G1/2" female supply fittings, spaced 150mm apart, level, vertical, and not more than 5mm if extending or below the finished wall surface. Hot supply pipe must be located on the left.

Install the two offset connectors(1) into the hot and cold supply fittings. Use appropriate thread sealants or thread tape onto the threads.

Adjust the center-to-center distance between the connectors to 150mm and level. They should extend 40 to 47 mm beyond the finished wall. Apply a ring of plumbers putty around the back edge of the escutcheons(2). Thread escutcheons(2) onto the connectors until they are against the finished wall. Remove any excess putty.

Put the washers(3) into the nuts(4). Thread the nuts onto the connectors(1) and tighten by the strap wrench.

如何安装花洒

去掉出水口(5)保护套。

手持花洒(8)的限流器不可取出。取出软管(7)一端接头内的垫片。将滤网垫片(6)放入软管接头内, 将毡垫(9)放入手持花洒内, 将手持花洒旋紧到软管上, 软管另一端连接出水口(5)。

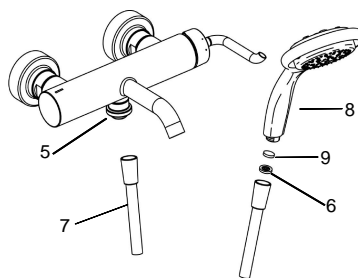

How to Install the Handspray

Remove the guard on the outlet(5).

Don't remove the regulator of handspray(8). Remove the washer from one connector of the hose(7). Put the screen washer(6) into the shower hose connector, put the filter(9) into the handspray, screw the handspray to the shower hose. Connect another end of shower hose to the faucet outlet(5).

如何安装托架

在墙面选一合适的位置来安装托架。

根据安装尺寸在墙壁上标出底座(11)安装孔位。根据胀塞(10)直径打孔,安装胀塞。旋紧螺钉(12),固定底座。在托架(13)底面边缘涂一圈油灰或密封胶,将托架旋紧到底座上。去除多余油灰或密封胶。

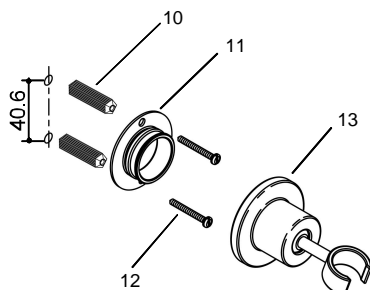

How to Install the Bracket

Determine a suitable location on the finished wall to install the bracket.

Mark bracket support(11) mounting hole locations on the wall according to the dimension. Drill two holes on the finished wall, the holes should match the anchors(10). Install the anchors. Tighten screws(12) to secure bracket support. Apply a ring of plumbers putty or sealant around the back surface of the bracket(13). Screw the bracket onto the bracket support. Remove any excess putty or sealant.

安装结果检查

检查并确保所有的衔接处都已拧紧。

确保手柄在“关”的位置。

打开排水系统和主要供水源,检查并修理有漏水的接口。

取下花洒并用附带的工具(15)取下起泡器(14)。打开冷热水,让水流出约一分钟以清除杂质。检查渗漏。清洗起泡器。关闭水龙头,并装回起泡器和花洒。

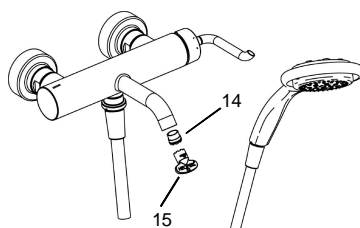

INSTALLATION CHECKOUT

Ensure that all coupling nuts are tightened.

Ensure that the handles are in the off position.

Turn on the main water supply, and check for leaks. Repair as needed.

Remove the handspray. Remove the aerator (14) by key(15). Run hot and cold water through the faucet for about one minute to remove any debris. Check for leaks. Remove any debris from the aerator. Shut off the faucet, and reinstall the aerator and handspray.

操作说明

OPERATION INSTRUCTIONS

旋转手持花洒头部可以获得不同水流方式,见右图。

Rotate the head of the handspray to change the spray patterns as shown.

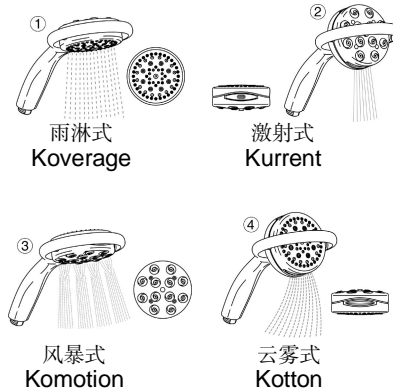

如何清除喷孔水垢,杂质

喷孔杂质或结垢会导致水流变形,流量变小。打开水源,用力按压或摩擦橡胶喷孔,去除杂质或水垢。

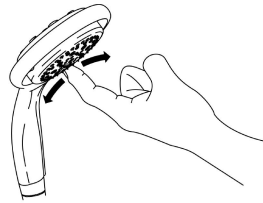

How to Clean the Nozzles

Any debris or mineral build-up may cause the flow stream to become distorted or reduce the flowrate. To remove the debris or mineral build-up, run water through the handspray, firmly press or rub your finger back and forth across the rubber nozzles.

如何清理滤网垫片

拆下手持花洒(8)。先将滤网垫片(6)和毡垫(9)从手持花洒中依次取出。用热醋清洗滤网垫片上的滤网,清洗垫片滤网和毡垫。重新将毡垫和滤网垫片装入手持花洒。重新装回手持花洒。

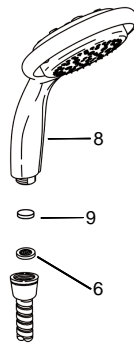

How to Clean the Screen Washer

Remove the handspray(8). Take out the screen washer(6) and the filter(9) from the handspray. Clean the filters of the screen washer by soaking them in warm vinegar. Clean the screen washer and filter. Reinstall the filter and screen washer into the handspray. Reinstall the handspray.

如何清洗云雾式出水口

用带尖工具把白色塞扣拨下。

用 2.5mm 六角扳手 (客户自备)把四个螺钉拆下。

将上下盖拆下后,即可拆下云雾式出水口。

用白醋浸泡 30 分钟后即可清除污垢。

注意:确保 O 型圈的位置正确。

按顺序装回所有零件。

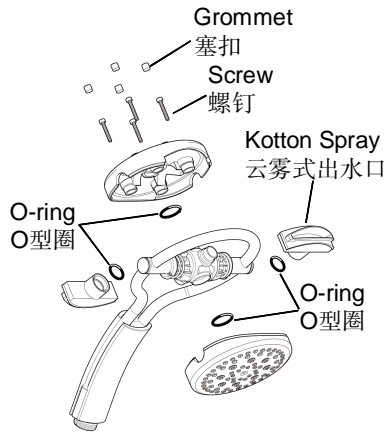

How to Clean the Kotton Spray

Use a suitable tool to remove the four grommets.

Using the 2.5mm hexagon wrench(not supplied), remove the four screws.

Separate the sprayplate assembly into its individual components.

Clean the kotton spray by soaking them in warm vinegar for 30 minutes.

NOTE: Make sure that the O-rings are located correctly.

Reassemble the components in reverse order.

清理说明

适用于所有加工处理过的表面:以中性肥皂水清洗镀层表面,再以干净的软布彻底擦干整个表面,许多清洁剂,比如氨水、去污粉及洁厕灵等,会对电镀表面造成伤害,切忌使用。

有磨损性的清洁用具或清洁剂也不可适用于科勒牌的水龙头及其配件上。

CLEANING INSTRUCTIONS

All Finishes: Clean the finish with a mild soap and warm water. Wipe entire surface completely dry with clean soft cloth. Many cleaners may contain chemicals, such as ammonia, chlorine, toilet cleaner etc. which could adversely affect the finish and are not recommended for cleaning.

Do not use abrasive cleaners or solvents on Kohler faucets and fittings.

7786T-4 挂墙式浴缸花洒龙头

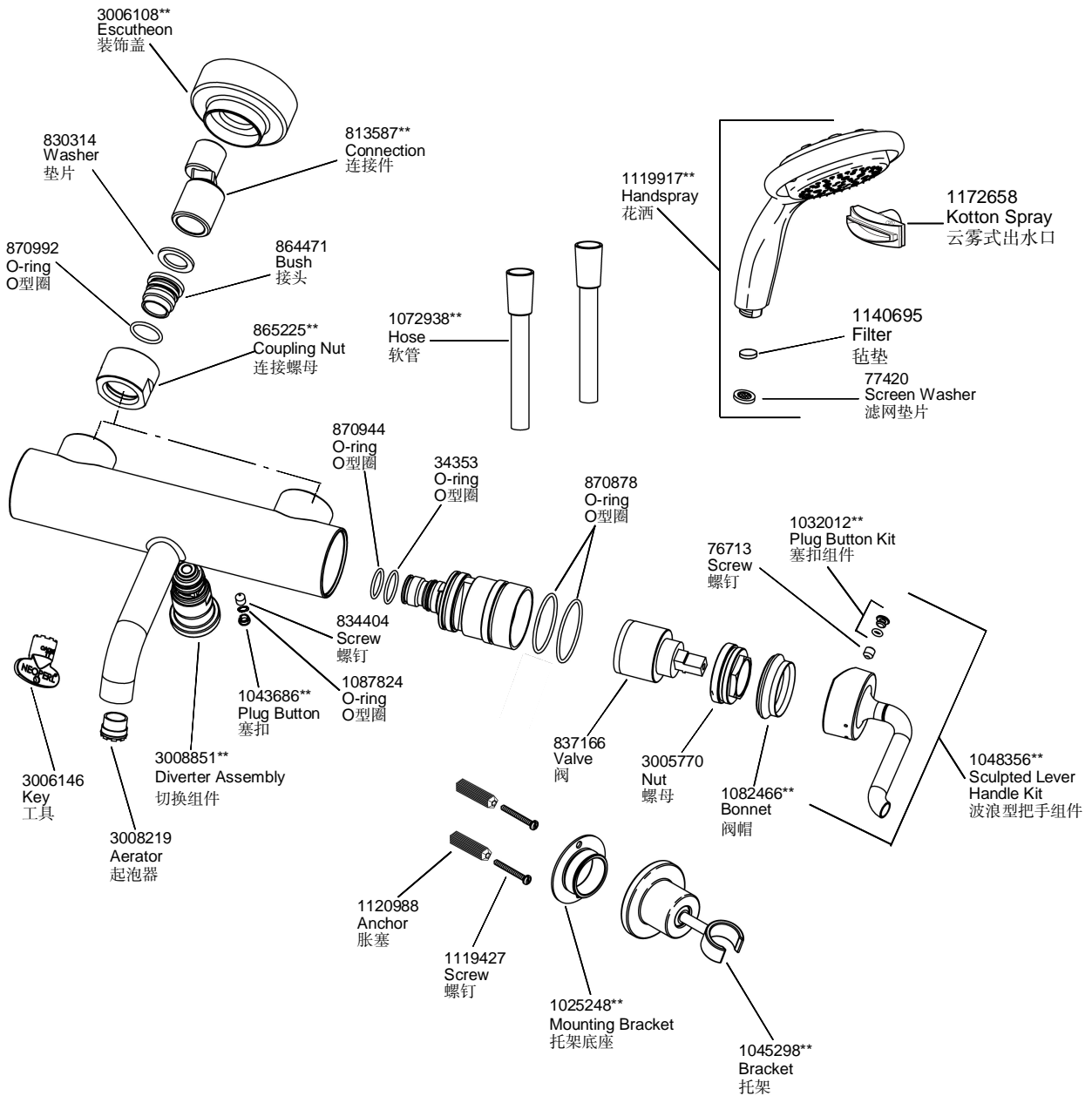

**订购时请说明颜色编号

**Color code must be specified when ordering.