

Features

- Modular Vanity - Build arrays both stacked and ganged
- Mates to both H1D21 (7.5" high) & H2D21 (15" high) Series
- Handleless ergonomic continuous drawer
- Tip-out front storage version allows for standard undermount sink

Construction

- All aluminum and glass construction - designed for disassembly and recycle, aluminum structural frame and drawer sides, glass drawer fronts, and safety backed glass drawer bottom
- Constructed for wall hanging loads with stone tops
- Glass fronts and optional side kits are replaceable
- Includes installation hardware using secure structural bolts
- Glass side kits sold separately

Codes / Standards Applicable

- Optional Night Light is ETL certified to:
 - UL 2108
 - CSA Standard C22.2 No. 250

Dimensions

Height: 7-1/2" (191 mm)
 Width: 30-1/8" (765 mm) - with side kits installed
 Depth: 21-3/4" (552 mm)

Options

- Choice of front Tip out, split plumbing drawer, or full width drawer
- Integrated LED night light (L) - Light bar built into top frame provides drawer illumination
- Glass finish options: Mirror, patterned glass, and back painted glass - gloss or matte
- Other widths available - 12" (308 mm) / 24" (613 mm) / 36" (918 mm)
- 15" (381 mm) drawer height available - H2
- Shallow depth available 18-3/4" (476 mm) - D18

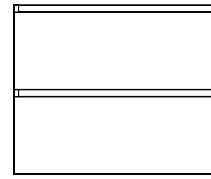
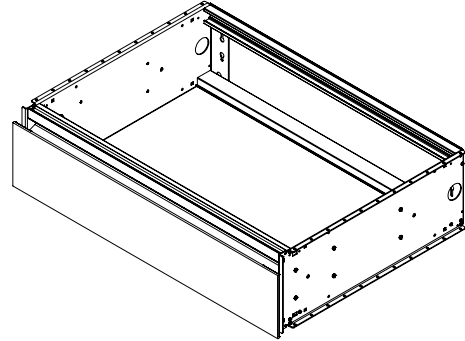

Two H2 - 15" (381 mm) Cartesian vanities stacked
 Total height 30" (762 mm)

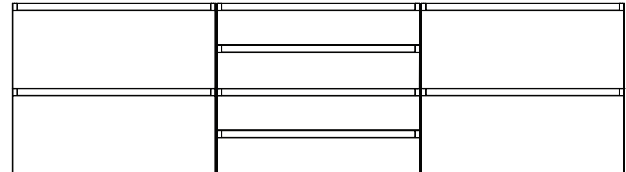

(2) H2 Cartesian vanities stacked + (4) H1 Cartesian vanities stacked + (2) H2 Cartesian vanities stacked

Model Number Key

Width	Height	Depth	Drawer Style	Glass Finish		Night light Option	
VM	30	H1	D21	T = Tip-Out	11 = Tinted Grey Mirror 16 = Matte Sand 17 = Matte Slate 20 = Black 21 = White	22 = Beach 26 = Matte White 27 = Matte Gray 28 = Matte Black 60 = Reeded White 61 = Reeded Brass 12 = Satin Bronze 19 = Satin White	N = Base Unit (Not Included) L = 5000K S = Selectable 2700K / 4000K

Electrical System

- Night light option - 12VDC plug-in transformer
Locate wall outlet as per installation instructions 209-1231

Optional Accessories

- Robern Engineered Stone Tops and porcelain sink available

Modularity Accessories

Available in 4 heights (based on final configuration)

- Side kits (**Single**):
 - 7-1/2" (VM1SKH1D21##)
 - 22-1/2" (VM1SKH3D21##)
 - 15" (VM1SKH2D21##)
 - 30" (VM1SKH4D21##)
- Side kits (**Pair**):
 - 7-1/2" (VM2SKH1D21##)
 - 22-1/2" (VM2SKH3D21##)
 - 15" (VM2SKH2D21##)
 - 30" (VM2SKH4D21##)
- Ganging kits:
 - 7-1/2" (VMGKITH1)
 - 22-1/2" (VMGKITH3)
 - 15" (VMGKITH2)
 - 30" (VMGKITH4)
- Alcove finishing kits:
 - 7-1/2" (VMAKITH1)
 - 22-1/2" (VMAKITH3)
 - 15" (VMAKITH2)
 - 30" (VMAKITH4)

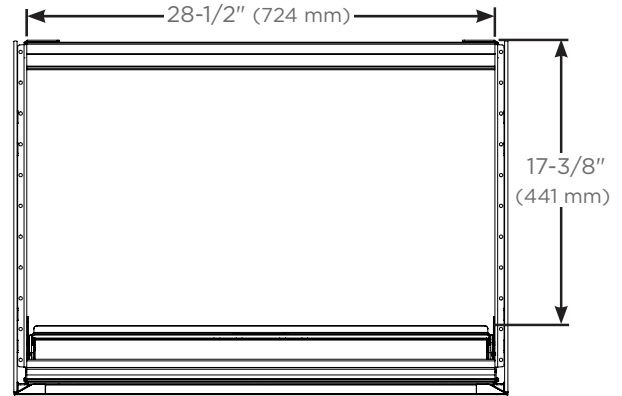

Top view for plumbing and sink clearance

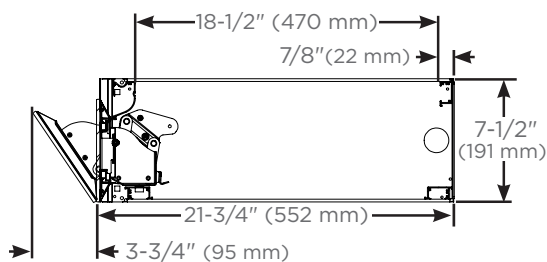

Side views for plumbing and sink clearance
with door front

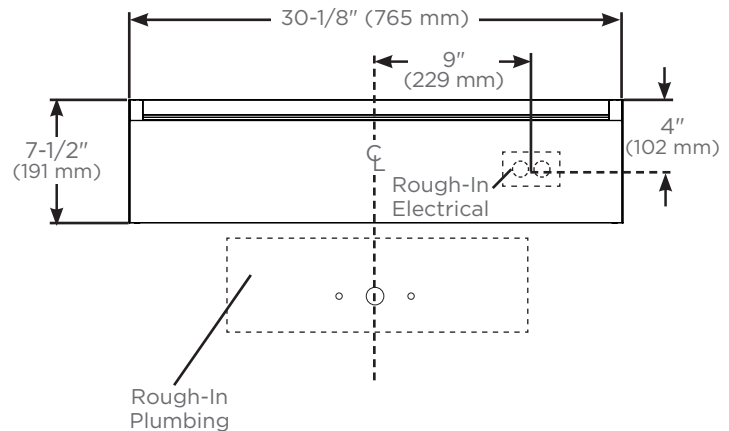

Front view with side kits

Installation Notes

Install this product according to the installation guide 209-1231.

- The Robern Engineered Stone Tops and porcelain sinks are recommended for this vanity.
- Special site preparation is required. Wall bracing and Robern supplied hardware are recommended.
- If a sink will be installed, the plumbing must be roughed into the plumbing cutout area of the vanity. Refer to the sink rough-in and the vanity rough-in for proper placement. The water supply and drain lines must be installed before installing the vanity.