

Features

- Drawer within a drawer provides easy access to smaller items
- Can be used in a dry styling space
- Insert drawer can be used in both Cartesian D18 & D21 depths
- Plumbing drawer to allow clearance for drain
- Handleless ergonomic continuous drawer
- Includes 5 glass organizing bins

Construction

- All aluminum and glass construction - designed for disassembly and recycle, aluminum structural frame and drawer sides, glass drawer fronts, and safety backed glass drawer bottom
- Heavy duty, full extension, soft close drawers slides
- Glass fronts are replaceable
- Includes installation hardware

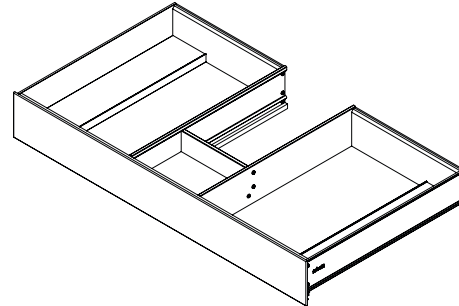

Dimensions

Height: 3-3/4" (95 mm)
 Width: 28-3/16" (716 mm)
 Depth: 15-3/8" (391 mm)

Options

- Choice of split plumbing or full width drawer
- Other widths available - 24" (564 mm) / 36" (868 mm)

Optional Accessories

- Assorted glass bins:
 - Divided storage (GLASSBIN6.38)
 - Small (GLASSBIN3.25)
 - Medium (GLASSBIN5.25)
 - Large (GLASSBIN8.5)

Model Number Key

<u>Vanity</u>	<u>Accessory</u>	<u>Feature/Function</u>	<u>Width</u>	<u>Drawer Style</u>
V	A	DRAWER	30 = 28-3/16"	P = Plumbing

VADRAWER in D18 - Plumbing and sink clearance

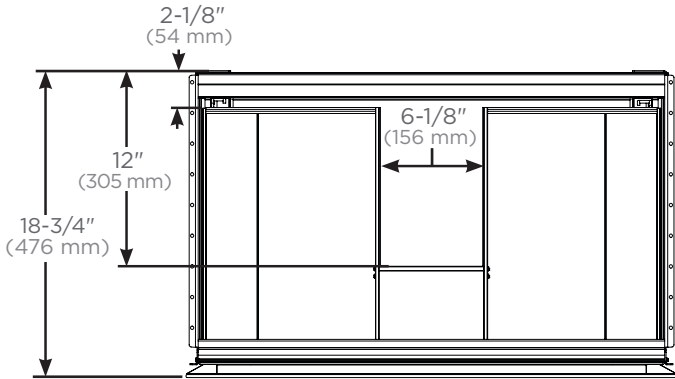

Top view for plumbing and sink clearance

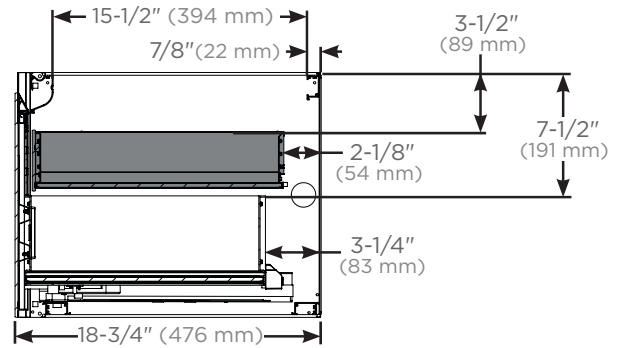

Side views for plumbing and sink clearance with door front

*Not compatible in locations where undercounter sinks are used or where a drain will need clearance.

VADRAWER in D21 - Plumbing and sink clearance

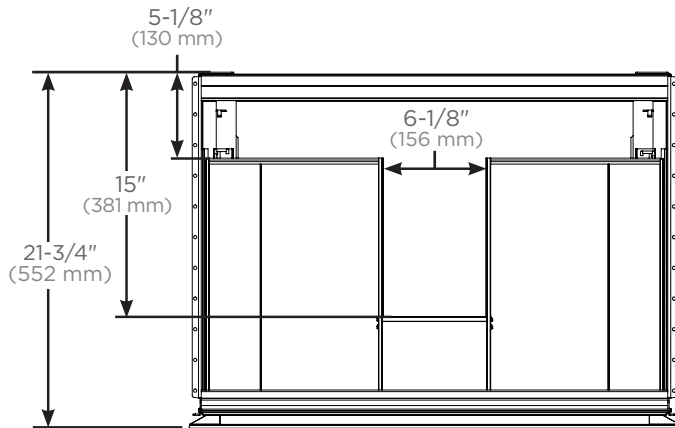

Top view for plumbing and sink clearance

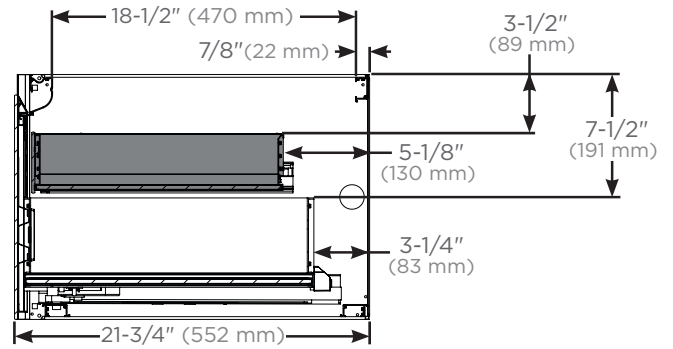

Side views for plumbing and sink clearance with door front

*Not compatible in locations where undercounter sinks are used or where a drain will need clearance.

Installation Notes

Install this product according to the installation guide 209-1247.

When using multiple vanity accessories, the VADRAWER Insert needs to be in a different vanity than the Hair Styling Organizer.