

Features

- Single-speed whirlpool offers performance and value with 8 fully adjustable jets
- Hydromassage flow and direction can be controlled at each jet
- Comfort Depth® design offers a convenient 19" step-over height while retaining the same depth as a standard 21" bath
- Integral lumbar support
- Slotted overflow allows for deep soaking
- Integral apron
- Integral flange helps prevent water from seeping behind wall and simplifies alcove installation
- Textured bottom surface
- Coordinates with other products in the Archer collection

Material

- Acrylic

Hydrotherapy

- Whirlpool

Installation

- Right drain
- Alcove

Required Products/Accessories

K-7271 Brass Slotted Overflow Bath Drain

or

K-7272 PVC Slotted Overflow Bath Drain

Recommended Products/Accessories

K-23726 Drain treatment

K-23732 Tub & shower cleaner

K-31797 Slotted overflow bath drain kit

K-31795 Slotted overflow above-the-floor bath drain kit



ADA

Codes/Standards

ASME A112.19.7/CSA B45.10

CSA B45.5/IAPMO Z124

UL 1795

ADA

ICC/ANSI A117.1

IAPMO Certification





UL Listed

KOHLER® Plastic Baths and Shower Bases Lifetime Limited Warranty KOHLER® Hydrotherapy Components Five-Year Limited Warranty

See website for detailed warranty information.

Available Colors/Finishes

Color tiles intended for reference only.

Color	Code	Description
	0	White
	96	Biscuit
	95	Ice™ Grey
	7	Black Black™

No change in measurements if connected with drain illustrated. (K-7272)

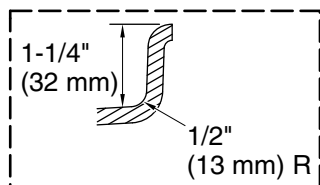

Integral Flange Detail

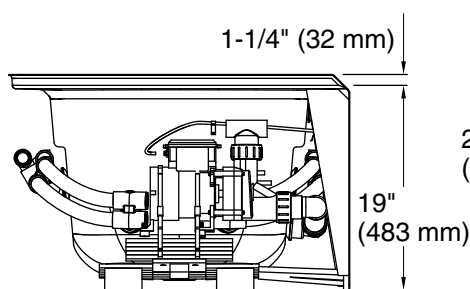
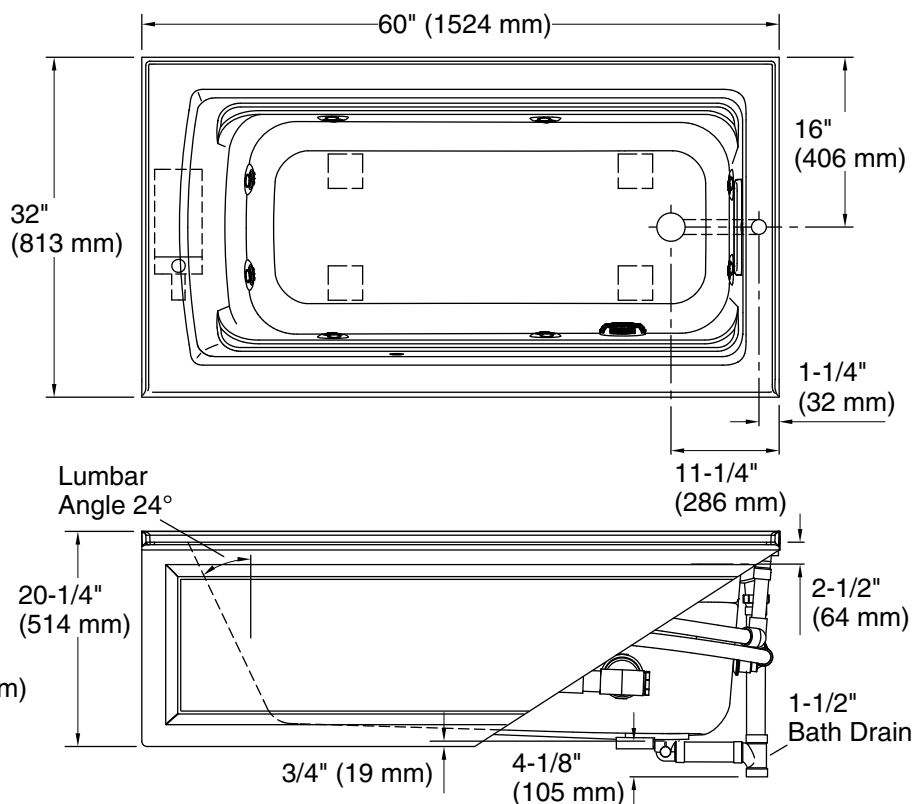

Required Electrical Service

One dedicated circuit required, protected with Class A Ground-Fault Circuit-Interrupter (GFCI). Outside North America, this device may be known as a Residual Current Device (RCD).

Pump: 120 V, 15 A, 60 Hz

Technical Information

All product dimensions are nominal.

Drain location: Right
 Basin area, bottom: 45-1/8" x 19-11/16" (1146 mm x 500 mm)
 Basin area, top: 52-3/4" x 25-5/16" (1340 mm x 643 mm)
 Weight: 135 lbs (61.2 kg)
 Minimum floor load: 49 lbs/ft² (239.2 kg/m²)
 Water depth: 15" (381 mm)
 Water capacity: 58 gal (219.6 L)
 Electrical component rating: Pump: 120 V, 7 A, 60 Hz
 Pump speed: Single
 Minimum flat for door: 2-9/16" (65 mm)

Notes

Measure your actual product for rough-in details.

Install this product according to the installation instructions.

The hot water supply should be 70% of the capacity of the bath or greater. Installations will vary.

ADA compliant when installed to the specific requirements of these regulations.