

Features

- 118 airjets release thousands of heated bubbles that surround and support the body in a warm massage
- Automatic and manual purge cycles remove residual water from air channels after use
- Variable-speed blower lets you adjust Heated BubbleMassage™ massage intensity to 18 levels
- Single-speed whirlpool revitalizes sore muscles
- Comfort Depth® design offers a convenient 19" step-over height while retaining the same depth as a standard 21" bath
- Integral lumbar support
- Slotted overflow allows for deep soaking
- Integral apron
- Integral flange helps prevent water from seeping behind wall and simplifies alcove installation
- Textured bottom surface
- Built-in 600W BubbleMassage™ heater warms humidified air before it enters the bath

Material

- Acrylic

Hydrotherapy

- Whirlpool

Technology

- Auto-shutoff timer on blower allows users to enjoy Heated BubbleMassage™ experience for 60 minutes before turning off
- User interface: electronic keypad control for Heated BubbleMassage™; air switch actuator for whirlpool

Installation

- Alcove
- Remote blower motor installation required (relocation kit is included)

Required Products/Accessories

K-7271 Brass Slotted Overflow Bath Drain

or

K-7272 PVC Slotted Overflow Bath Drain

Recommended Products/Accessories

K-1446 Remote Installation Kit

K-23726 Drain treatment

K-23732 Tub & shower cleaner

K-31797 Slotted overflow bath drain kit

K-31795 Slotted overflow above-the-floor bath drain kit



ADA

Codes/Standards

ASME A112.19.7/CSA B45.10

CSA B45.5/IAPMO Z124

ASTM E162

ASTM E662

UL 1795

CSA C22.2 No. 218.2

ADA

ICC/ANSI A117.1

IAPMO Certification

cUL Listed







UL Listed

KOHLER® Hydrotherapy Components Five-Year Limited Warranty KOHLER® Plastic Baths and Shower Bases Lifetime Limited Warranty

See website for detailed warranty information.

Available Colors/Finishes

Color tiles intended for reference only.

Color	Code	Description
	0	White
	96	Biscuit
	NY	Dune
	95	Ice™ Grey
	58	Thunder™ Grey
	7	Black Black™

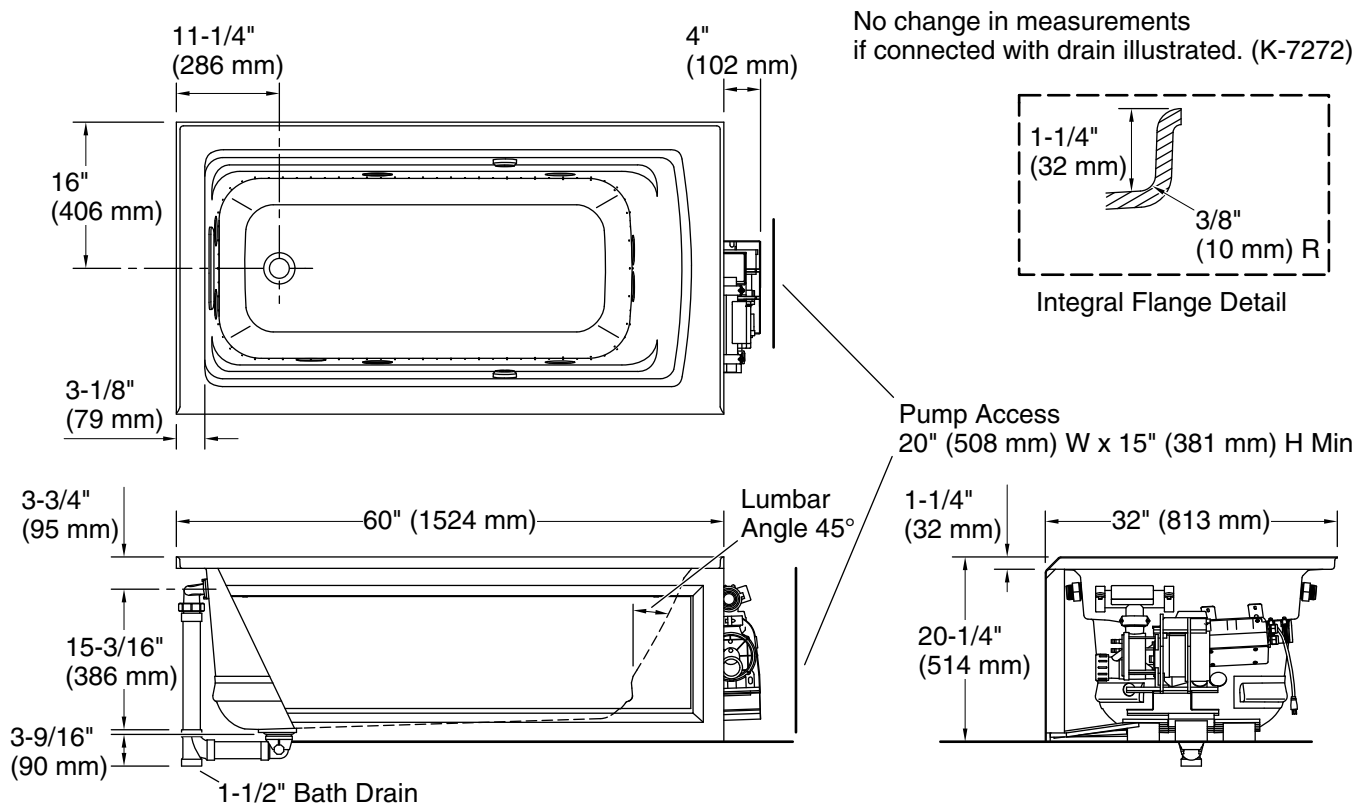

Required Electrical Service

Three dedicated circuits required, protected with Class A Ground-Fault Circuit-Interrupter (GFCI). Outside North America, this device may be known as a Residual Current Device (RCD).

Pump, Heater, 120 V, 15 A, 60 Hz
Blower:

Technical Information

All product dimensions are nominal.

Drain location: Left
Basin area, bottom: 45-1/8" x 19-11/16" (1146 mm x 500 mm)
Basin area, top: 52-3/4" x 25-5/16" (1340 mm x 643 mm)
Weight: 165 lbs (74.8 kg)
Minimum floor load: 52 lbs/ft² (253.9 kg/m²)
Water depth: 15" (381 mm)
Water capacity: 58 gal (219.6 L)
Electrical component rating: Pump: 120 V, 7 A, 60 Hz
 Heater: 120 V, 5 A, 60 Hz
 Blower: 120 V, 12 A, 60 Hz
Minimum flat for 2-9/16" (65 mm)

Notes

- Measure your actual product for rough-in details.
- Install this product according to the installation instructions.
- The hot water supply should be 70% of the capacity of the bath or greater. Installations will vary.
- Remote blower installation kit is available for relocating the blower. Provide access for servicing the blower.
- Do not relocate or alter the PVC tee or coiled flexible tubing connected to the blower. Follow the blower relocation instructions exactly.
- ADA compliant when installed to the specific requirements of these regulations.