

72" x 36" alcove Heated BubbleMassage™ air bath with Bask® heated surface, right drain K-1124-GHRAW

Features

- Bask® heated surface creates spa-like relaxation with soothing warmth on your back, shoulders, and neck
- Three heat settings allow you to customize the surface temperature
- 120 airjets release thousands of heated bubbles that surround and support the body in a warm massage
- Automatic and manual purge cycles remove residual water from air channels after use
- Variable-speed blower lets you adjust massage intensity to 18 levels
- Comfort Depth® design offers a convenient 19" step-over height while retaining the same depth as a standard 21" bath
- Integral lumbar support
- Slotted overflow allows for deep soaking
- Integral apron
- Integral flange helps prevent water from seeping behind wall and simplifies alcove installation
- Textured bottom surface
- Right drain
- Coordinates with other products in the Archer collection
- Built-in 600W BubbleMassage™ heater warms humidified air before it enters the bath
- Automatic and manual purge cycles remove residual water from air channels after use
- Built-in 60W electric heater included to keep bath surface warm

Material

- Acrylic

Technology

- Auto-shutoff timer on blower allows users to enjoy Heated BubbleMassage™ experience for 60 minutes before turning off
- User interface: two separate electronic keypad controls for Heated BubbleMassage™ and Bask®

Installation

- Alcove

Required Products/Accessories

K-7271 Brass Slotted Overflow Bath Drain

or

K-7272 PVC Slotted Overflow Bath Drain

Recommended Products/Accessories

K-1446 Remote Installation Kit

K-23726 Drain treatment



Codes/Standards

ASME A112.19.7/CSA B45.10

CSA B45.5/IAPMO Z124

ASTM E162

ASTM E662

UL 1795

CSA C22.2 No. 218.2

IAPMO Certification

cUL Listed







UL Listed

KOHLER® Plastic Baths and Shower Bases Lifetime Limited Warranty KOHLER® Hydrotherapy Components Five-Year Limited Warranty

See website for detailed warranty information.

Available Colors/Finishes

Color tiles intended for reference only.

| Color | Code | Description |
|---|------|---------------|
|  | 0 | White |
|  | 96 | Biscuit |
|  | NY | Dune |
|  | 95 | Ice™ Grey |
|  | 58 | Thunder™ Grey |
|  | 7 | Black Black™ |

72" x 36" alcove Heated BubbleMassage™ air bath with Bask® heated surface, right drain K-1124-GHRAW

No change in measurements if connected with drain illustrated. (K-7272)

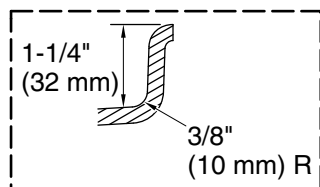

Integral Flange Detail

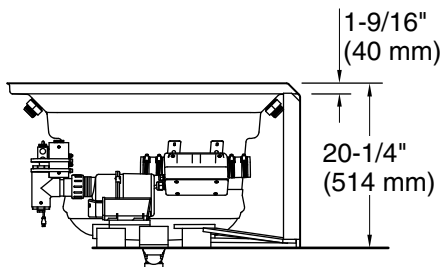
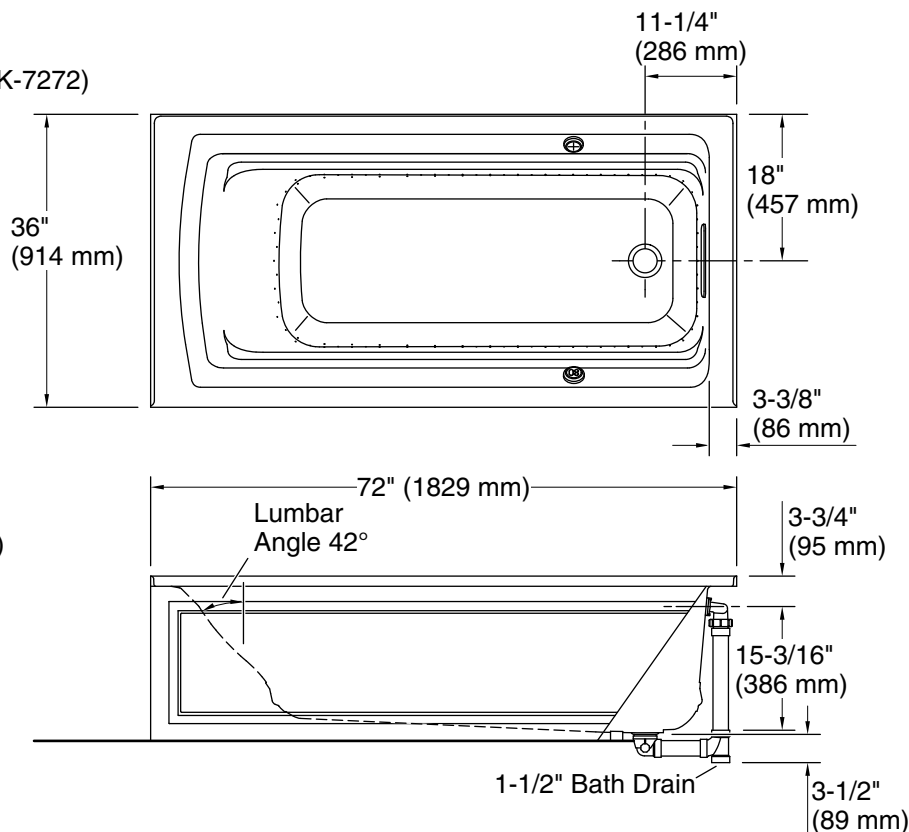

Required Electrical Service

Two dedicated circuits required, protected with Class A Ground-Fault Circuit-Interrupter (GFCI). Outside North America, this device may be known as a Residual Current Device (RCD).

| | |
|----------------|--------------------|
| Blower, Heated | 120 V, 15 A, 60 Hz |
| Surface: | |
| Heater: | 120 V, 15 A, 60 Hz |

Technical Information

All product dimensions are nominal.

| | |
|------------------------------|--|
| Drain location: | Right |
| Basin area, top: | 64-1/2" x 30-1/2" (1638 mm x 775 mm) |
| Weight: | 121 lbs (54.9 kg) |
| Minimum floor load: | 42 lbs/ft ² (205.1 kg/m ²) |
| Water depth: | 15" (381 mm) |
| Water capacity: | 72 gal (272.5 L) |
| Electrical component rating: | Blower: 120 V, 10 A, 60 Hz Heated Surface: 120 V, 0.5 A, 60 Hz Heater: 120 V, 5 A, 60 Hz |
| Minimum flat for door: | 2" (51 mm) |

Notes

- Measure your actual product for rough-in details.
- Install this product according to the installation instructions.
- The hot water supply should be 70% of the capacity of the bath or greater. Installations will vary.
- Remote blower installation kit is available for relocating the blower. Provide access for servicing the blower.
- Do not relocate or alter the PVC tee or coiled flexible tubing connected to the blower. Follow the blower relocation instructions exactly.