

Features

- Bask® heated surface creates spa-like relaxation with soothing warmth on your back, shoulders, and neck
- Three heat settings allow you to customize the surface temperature
- Comfort Depth® design offers a convenient 19" step-over height while retaining the same depth as a standard 21" bath
- Generous length provides a spacious bathing area
- Integral lumbar support
- Slotted overflow allows for deep soaking
- Integral apron
- Integral flange helps prevent water from seeping behind wall and simplifies alcove installation
- Textured bottom surface
- Coordinates with other products in the Archer collection

Material

- Acrylic

Installation

- Right drain
- Alcove

Required Products/Accessories

K-7271 Brass Slotted Overflow Bath Drain

or

K-7272 PVC Slotted Overflow Bath Drain

Recommended Products/Accessories

K-1491 Bath/Whirlpool Pillow

K-1601 Bath/whirlpool footstop, removable

K-23726 Drain treatment

K-23732 Tub & shower cleaner

K-31797 Slotted overflow bath drain kit

K-31795 Slotted overflow above-the-floor bath drain kit



ADA

Codes/Standards

CSA B45.5/IAPMO Z124

ADA

ICC/ANSI A117.1





IAPMO Certification

KOHLER® Plastic Baths and Receptors Lifetime Limited Warranty KOHLER® Hydrotherapy Components Five-Year Limited Warranty

See website for detailed warranty information.

Available Colors/Finishes

Color tiles intended for reference only.

Color	Code	Description
	0	White
	96	Biscuit
	95	Ice™ Grey
	7	Black Black™



Archer®

72" x 36" alcove bath with Bask® heated surface,
alcove, right drain
K-1125-RAW

No change in measurements if connected with drain illustrated. (K-7272)

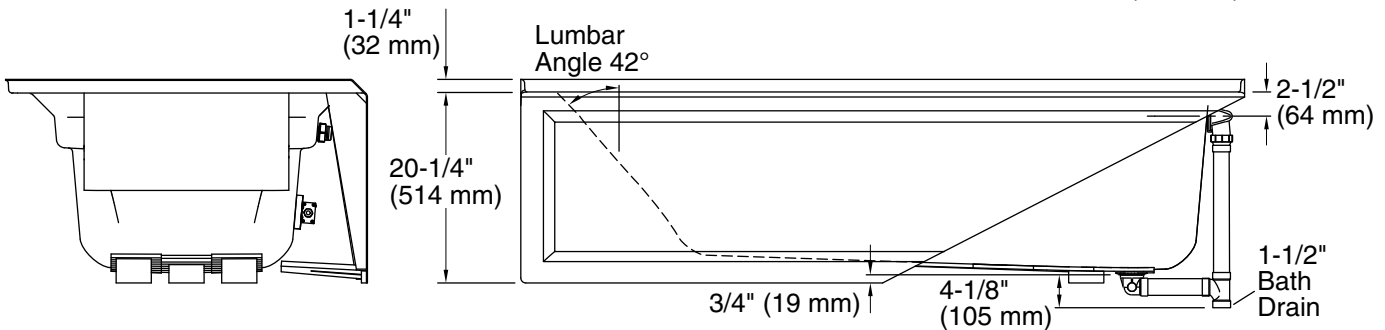
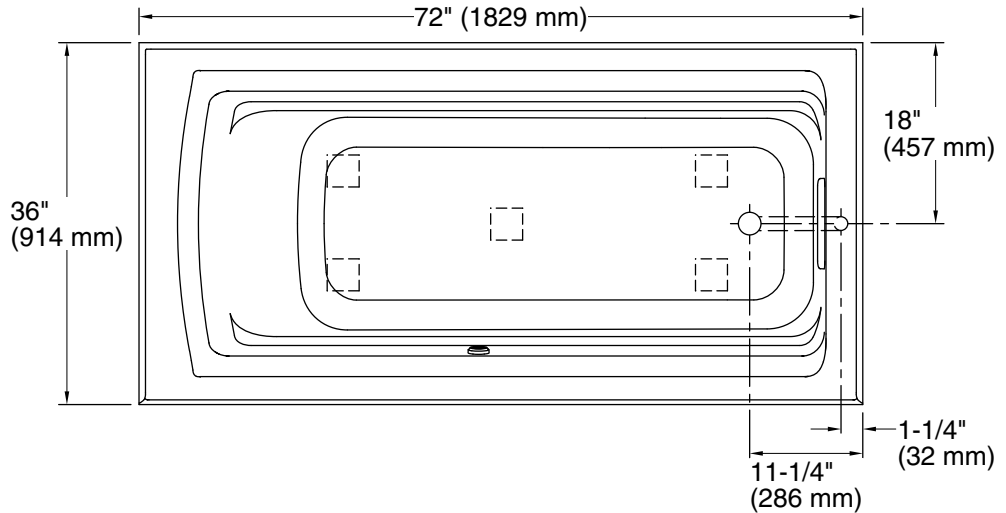
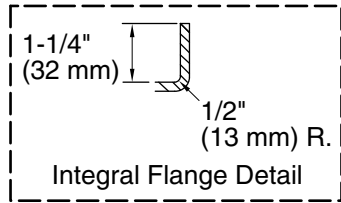

Required Electrical Service

One circuit required, protected with Class A Ground-Fault Circuit-Interrupter (GFCI). Outside North America, this device may be known as a Residual Current Device (RCD).

Heated Surface: 120 V, 15 A

Technical Information

All product dimensions are nominal.

- Drain location: Right
- Basin area, bottom: 51-3/8" x 21" (1305 mm x 533 mm)
- Basin area, top: 64-1/2" x 30-1/2" (1638 mm x 775 mm)
- Weight: 80 lbs (36.3 kg)
- Minimum floor load: 40 lbs/ft² (195.3 kg/m²)
- Water depth: 15" (381 mm)
- Water capacity: 72 gal (272.5 L)
- Electrical component rating: Heated Surface: 120 V, 0.5 A, 60 Hz, 65 W
- Minimum flat for door: 2" (51 mm)

Notes

Measure your actual product for rough-in details.

Install this product according to the installation instructions.

The hot water supply should be 70% of the capacity of the bath or greater. Installations will vary.

ADA compliant when installed to the specific requirements of these regulations.