

Features

- Eight Proflex® hydromassage jets can be individually adjusted for water flow and direction
- Single-speed whirlpool offers performance and value with 8 fully adjustable jets
- Built-in heater
- Slotted overflow allows for deep soaking
- Spacious design accommodates up to two bathers
- Integral lumbar support
- Textured bottom surface

Material

- Acrylic

Installation

- Drop-in or undermount
- Reversible drain

Required Products/Accessories

K-7271 Brass Slotted Overflow Bath Drain

or

K-7272 PVC Slotted Overflow Bath Drain

Recommended Products/Accessories

K-1491 Bath/Whirlpool Pillow

K-1601 Bath/whirlpool footstop, removable

K-591 Under-Mount Installation Kit (Qty 2)

K-31797 Slotted overflow bath drain kit

K-31795 Slotted overflow above-the-floor bath drain kit



Codes/Standards

ASME A112.19.7/CSA B45.10

CSA B45.5/IAPMO Z124

ASTM E162

ASTM E662

UL 1795

CSA C22.2 No. 218.2

IAPMO Certification

cUL Listed







UL Listed

KOHLER® Plastic Baths and Shower Bases Lifetime Limited Warranty KOHLER® Hydrotherapy Components Five-Year Limited Warranty

See website for detailed warranty information.

Available Colors/Finishes

Color tiles intended for reference only.

Color	Code	Description
	0	White
	96	Biscuit
	NY	Dune
	95	Ice™ Grey
	58	Thunder™ Grey
	7	Black Black™

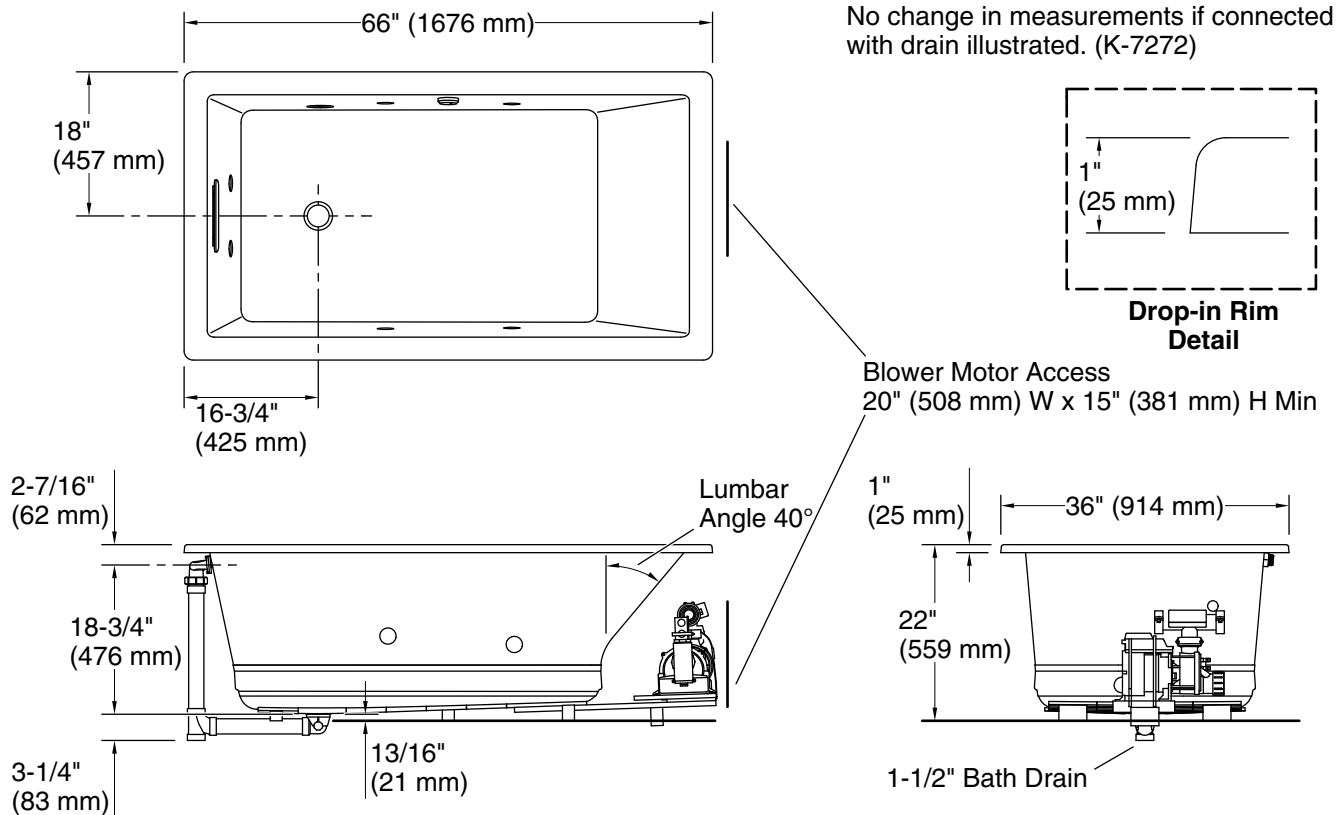

Required Electrical Service

Two dedicated circuits required, protected with Class A Ground-Fault Circuit-Interrupter (GFCI). Outside North America, this device may be known as a Residual Current Device (RCD).

Pump: 120 V, 15 A, 60 Hz
 Heater: 120 V, 15 A, 60 Hz

Technical Information

All product dimensions are nominal.

Drain location: Reversible
 Basin area, bottom: 44-1/2" x 26-7/16" (1130 mm x 671 mm)
 Basin area, top: 60-1/4" x 30-1/4" (1530 mm x 769 mm)
 Weight: 125 lbs (56.7 kg)
 Minimum floor load: 61 lbs/ft² (297.8 kg/m²)
 Water depth: 17-3/4" (450 mm)
 Water capacity: 100.4 gal (380.1 L)
 Cutout: Drop-in, 65" x 35" (1651 mm x 889 mm)
 Electrical component rating: Pump: 120 V, 7 A, 60 Hz
 Heater: 120 V, 12 A, 60 Hz
 Minimum flat for door: 2-7/16" (61 mm)

Notes

Measure your actual product for rough-in details.

Install this product according to the installation instructions.

The hot water supply should be 70% of the capacity of the bath or greater. Installations will vary.