

KOHLER® Faucets

Widespread bathroom sink faucet with Cross handles,
1.2 gpm
K-14406-3

Features

- Metal construction
- 5-1/2" (140 mm) spout reach
- Stationary spout
- Quarter-turn washerless ceramic disc valves
- Cross handles
- Low gooseneck spout
- 1.2 gpm (4.5 lpm) maximum flow rate at 60 psi (4.14 bar)
- Metal touch-activated drain with 1-1/4" tailpiece

Material

- Brass valve bodies
- KOHLER® finishes resist corrosion and tarnishing

Installation

- For 8" – 16" (203 – 406 mm) centers

Recommended Products/Accessories

- K-23726 Drain treatment
- K-23723 Faucet cleaner
- K-14375 24" Double Towel Bar
- K-14377 Pivoting toilet paper holder
- K-14435 18" Towel Bar
- K-14436 24" Towel Bar
- K-14441 Towel Ring
- K-14443 Robe Hook
- K-14444 Vertical toilet paper holder



Codes/Standards









ASME A112.18.1/CSA B125.1
NSF/ANSI/CAN 61
NSF/ANSI/CAN 372
All applicable US Federal and State material regulations
DOE - Energy Policy Act 1992
EPA WaterSense®
California Energy Commission (CEC)
IAPMO Certification

KOHLER® Faucet Lifetime Limited Warranty

See website for detailed warranty information.

Available Colors/Finishes

Color tiles intended for reference only.

Color	Code	Description
	CP	Polished Chrome
	SN	Vibrant® Polished Nickel
	AF	Vibrant® French Gold
	BN	Vibrant® Brushed Nickel
	BV	Vibrant® Brushed Bronze
	BL	Matte Black
	2MB	Vibrant® Brushed Moderne Brass
	TT	Vibrant Titanium

1-800-4KOHLER (1-800-456-4537)

Kohler Co. reserves the right to make revisions without notice to product specifications.

For the most current Specification Sheet, go to www.kohler.com USA or www.kohler.ca Canada

10-22-2024 00:29 - US/CA

THE BOLD LOOK
OF **KOHLER**®

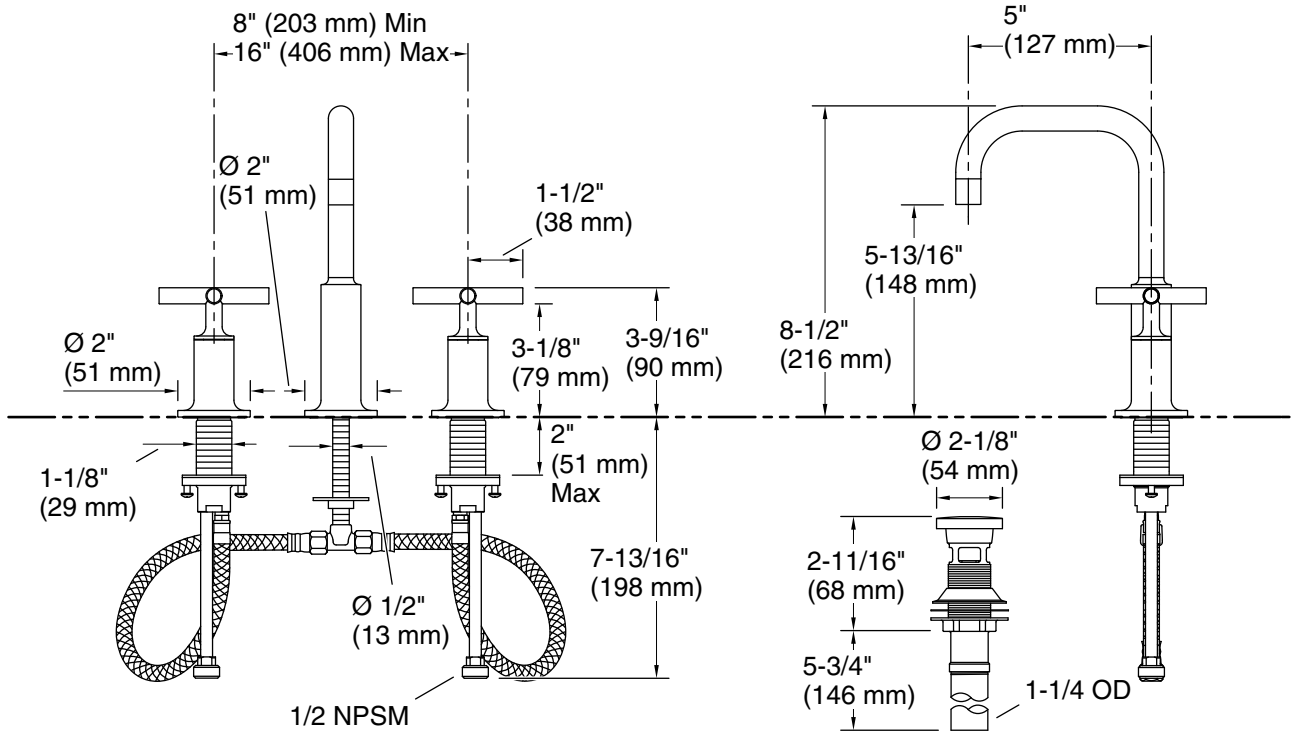

Technical Information

All product dimensions are nominal.

Faucet:

Flow rate: 1.2 gal/min (4.5 l/min)

Drain included: Yes

Spout:

Spout reach: 5" (127 mm)

Handshower:

Rated maximum flow: 0 gal/min (0 l/min)

Notes

Install this product according to the installation guide.

ADA compliant for handles only.