

Features

- Touchless faucet, soap dispenser, and accessory combination designed for Constellation™ 90" wall-mount lavatory systems
- Faucets with Kinesis® technology and concealed sensors give a clean aesthetic and provide extraordinarily accurate and reliable actuation in varying installation environments
- 0.5 gpm (1.9 lpm) maximum flow rate
- On-demand usage with 30-second max. continual run cycle to prevent vandalism and save water
- Vandal-resistant aerators
- Soap dispensers possess adjustable volume and sensor range for precise actuations
- Soap dispenser requires low (1-20 cps or gr/m-s) viscosity foam soap with no suspended particles. Please see Installation Guide or Maintenance and Use Guide for specific soap recommendations
- Below-counter faucet valving and soap dispenser reservoirs reduce footprints and provide easier servicing
- Vandal-resistant sensor on soap dispenser delays dispensing for 30 seconds if blocked for ten seconds
- Above-counter low soap and low battery indicators
- Coordinating bag hooks hold purses, backpacks, and other bags
- Includes three assembled faucets and soap dispensers, two bag hooks, two multi-outlet power supplies, six 10' (3.1 m) cable assemblies, three overflow assemblies, one 1-gallon bulk soap refill, mechanical mixing tee

Material

- Durable brass construction

Installation

- Deck-mount



ADA

Codes/Standards

ASME A112.18.1/CSA B125.1
NSF/ANSI/CAN 61
NSF/ANSI/CAN 372
UL 1310
ADA
ICC/ANSI A117.1

KOHLER® One-Year Limited Warranty

See website for detailed warranty information.

Available Colors/Finishes

Color tiles intended for reference only.

Color	Code	Description
	CP	Polished Chrome

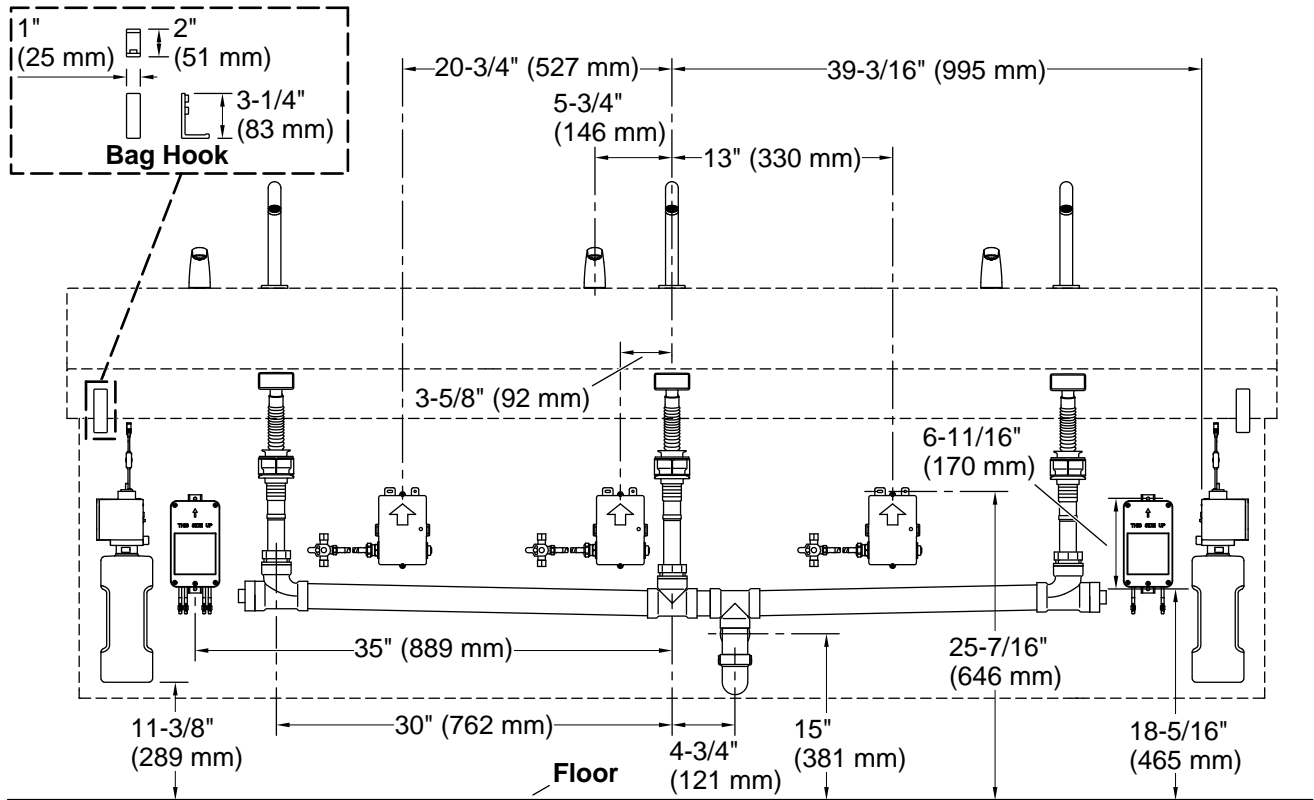

Required Electrical Service

One dedicated circuit required, protected with Class A Ground-Fault Circuit-Interrupter (GFCI). Outside North America, this device may be known as a Residual Current Device (RCD).
 110/220 V, 50/60 Hz

Notes

Install this product according to the installation instructions.
 ADA compliant when installed to the specific requirements of these regulations.

Technical Information

All product dimensions are nominal.

Power source: Hardwire - AC and Plug - AC, included

Faucet:

Flow rate: 0.5 gal/min (1.9 l/min)

Drain included: Yes

Drain with overflow: No

Spout:

Spout reach: 4-7/8" (124 mm)

Pressure/fixture Supply Requirements

Fixture pressure max (static): 80 psi (551.6 kPa)

Fixture pressure min (static): 25 psi (172.4 kPa)

1-800-4KOHLER (1-800-456-4537)

Kohler Co. reserves the right to make revisions without notice to product specifications.

For the most current Specification Sheet, go to www.kohler.com USA or www.kohler.ca Canada

1-6-2025 20:36 - US/CA