

Features

- Bask® heated surface creates spa-like relaxation with soothing warmth on your back, shoulders, and neck
- Three heat settings allow you to customize the surface temperature
- Comfort Depth® design offers a convenient 19" step-over height while retaining the same depth as a standard 21" bath
- Integral lumbar support
- Slotted overflow allows for deep soaking
- Textured bottom surface
- Coordinates with other products in the Archer collection

Material

- Acrylic

Installation

- Reversible drain
- Drop-in

Required Products/Accessories

K-7271 Brass Slotted Overflow Bath Drain

or

K-7272 PVC Slotted Overflow Bath Drain

Recommended Products/Accessories

K-23726 Drain treatment

K-23732 Tub & shower cleaner

K-31797 Slotted overflow bath drain kit

K-31795 Slotted overflow above-the-floor bath drain kit



ADA

Codes/Standards

CSA B45.5/IAPMO Z124

UL 1795

ADA

ICC/ANSI A117.1

IAPMO Certification





UL Listed

**KOHLER® Plastic Baths and
Receptors Lifetime Limited
Warranty KOHLER® Hydrotherapy
Components Five-Year Limited
Warranty**

See website for detailed warranty information.

Available Colors/Finishes

Color tiles intended for reference only.

Color	Code	Description
	0	White
	96	Biscuit
	95	Ice™ Grey
	7	Black Black™

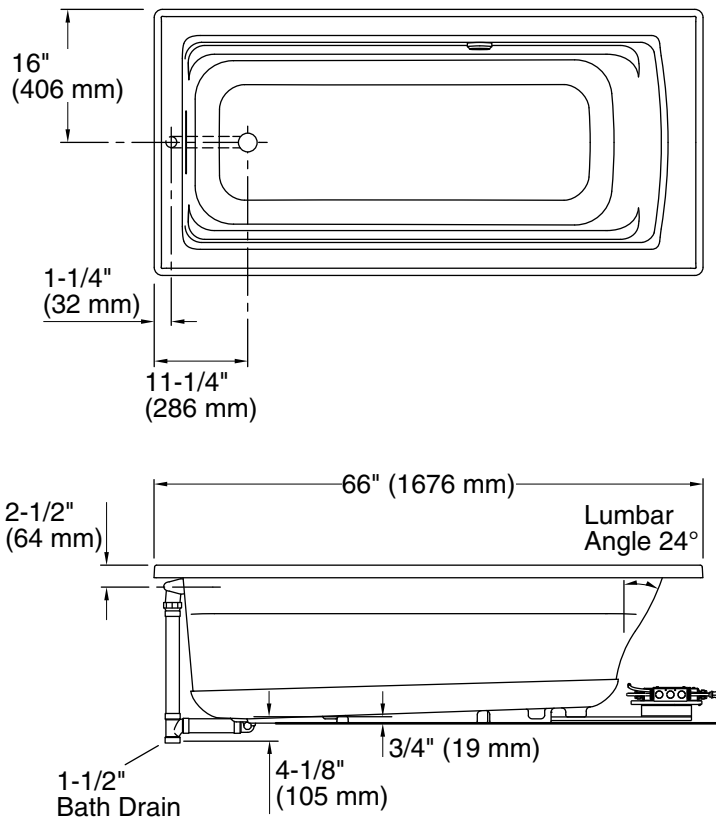

No change in measurements if connected with drain illustrated. (K-7272)

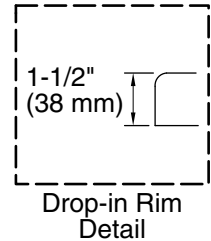

Access Panel
30" (762 mm) W x
15" (381 mm) H

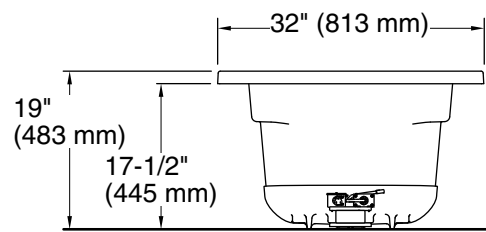

Required Electrical Service

One circuit required, protected with Class A Ground-Fault Circuit-Interrupter (GFCI). Outside North America, this device may be known as a Residual Current Device (RCD).

Heated Surface: 120 V, 15 A, 60 Hz

Technical Information

All product dimensions are nominal.

Drain location:	Reversible
Basin area, bottom:	50-3/8" x 19-5/8" (1280 mm x 498 mm)
Basin area, top:	57-5/16" x 24-1/16" (1456 mm x 611 mm)
Weight:	76 lbs (34.5 kg)
Minimum floor load:	45.4 lbs/ft ² (221.7 kg/m ²)
Water depth:	15-5/16" (389 mm)
Water capacity:	66 gal (249.8 L)
Cutout:	Drop-in, 64-1/2" x 30-1/2" (1638 mm x 775 mm)
Electrical component rating:	Heated Surface: 120 V, 0.5 A, 50/60 Hz, 65 W
Minimum flat for	2-1/8" (54 mm)

Notes

Measure your actual product for rough-in details.

Install this product according to the installation instructions.

The hot water supply should be 70% of the capacity of the bath or greater. Installations will vary.

This product is designed for drop-in installation only. It is not suited for use in a three-wall alcove with an overhead shower.

ADA compliant when installed to the specific requirements of these regulations.