

## Features

- Left-hand trip lever
- For use with the K-20197 and K-20198 Betello™ toilets

## Material

- Premium metal construction for durability and reliability
- KOHLER® finishes resist corrosion and tarnishing

## Recommended Products/Accessories

K-23723 Faucet cleaner



ADA

CSA B651

OBC

## Codes/Standards

ADA

ICC/ANSI A117.1

CSA B651









OBC

## KOHLER® One-Year Limited Warranty

See website for detailed warranty information.

## Available Colors/Finishes

*Color tiles intended for reference only.*

Color	Code	Description
	CP	Polished Chrome
	SN	Vibrant® Polished Nickel
	AF	Vibrant® French Gold
	BN	Vibrant® Brushed Nickel
	BV	Vibrant® Brushed Bronze
	BL	Matte Black
	2MB	Vibrant® Brushed Moderne Brass
	TT	Vibrant Titanium

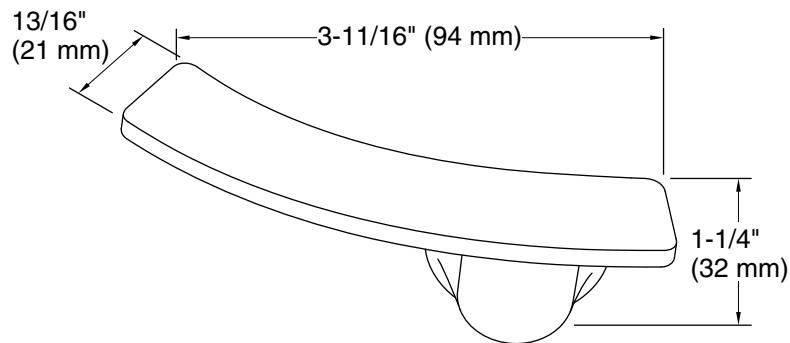

### Technical Information

All product dimensions are nominal.

Material: Metal

### Notes

ADA, OBC, CSA B651 compliant when installed to the specific requirements of these regulations.