

### Features

- A single handle controls both on/off activation and temperature setting
- 8" (203 mm) spout height
- 5-3/8" (137 mm) spout reach
- 1.2 gpm (4.5 lpm) maximum flow rate at 60 psi (4.14 bar)
- KOHLER® ceramic disc valves exceed industry longevity standards for a lifetime of durable performance
- Includes pop-up drain with lift rod and 1-1/4" (32 mm) tailpiece
- Ideal for vessel sink applications
- Coordinates with other products in the Parallel collection

### Material

- Premium metal construction for durability and reliability
- KOHLER® finishes resist corrosion and tarnishing

### Installation

- Single hole
- Preattached flexible supply lines simplify installation

### Recommended Products/Accessories

- K-23726 Drain treatment
- K-23723 Faucet cleaner
- K-21897 Double toilet paper holder
- K-23524 18" towel bar
- K-23525 24" towel bar
- K-23526 Towel arm
- K-23527 Vertical toilet paper holder
- K-23528 Pivoting toilet paper holder
- K-23529 Robe hook



### Codes/Standards







ASME A112.18.1/CSA B125.1  
NSF/ANSI/CAN 61  
NSF/ANSI/CAN 372  
All applicable US Federal and State material regulations  
DOE - Energy Policy Act 1992  
EPA WaterSense®  
California Energy Commission (CEC)  
IAPMO Certification

### KOHLER® Faucet Lifetime Limited Warranty

See website for detailed warranty information.

### Available Colors/Finishes

*Color tiles intended for reference only.*

Color	Code	Description
	CP	Polished Chrome
	SN	Vibrant® Polished Nickel
	AF	Vibrant® French Gold
	BN	Vibrant® Brushed Nickel
	BV	Vibrant® Brushed Bronze
	BL	Matte Black
	2MB	Vibrant® Brushed Moderne Brass
	TT	Vibrant Titanium

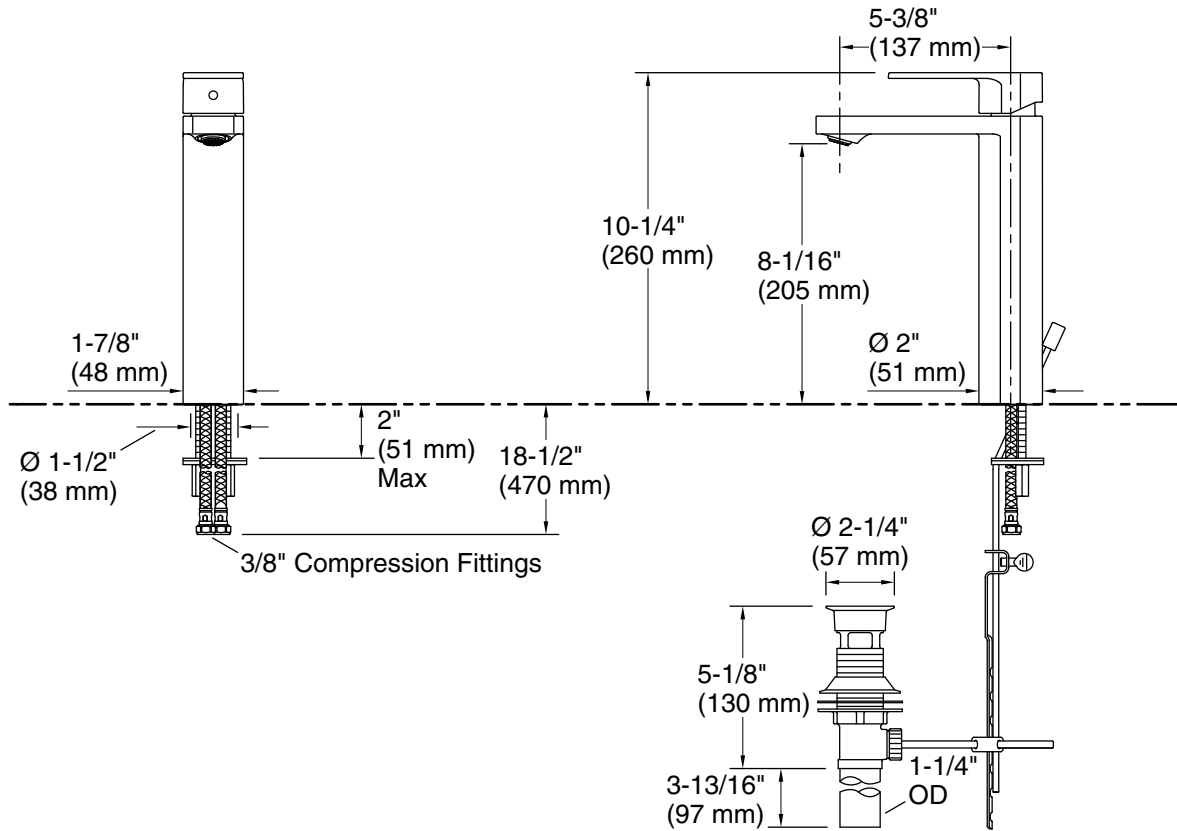

### Technical Information

All product dimensions are nominal.

#### Faucet:

Flow rate: 1.2 gal/min (4.5 l/min)

Drain included: Yes

#### Spout:

Spout reach:  $5\text{-}5/16"$  (135 mm)

#### Handshower:

Rated maximum flow: 0 gal/min (0 l/min)

### Notes

Install this product according to the installation instructions.