

### Features

- 6-11/16" (170 mm) spout reach
- Tall height is ideal for vessel-style sinks
- 1.2 gpm (4.5 lpm) maximum flow rate at 60 psi (4.14 bar)
- Laminar flow
- Includes metal touch-activated drain with 1-1/4" tailpiece
- Coordinates with Components faucets, accessories, and showering components to complete your bathroom
- This product can help a building earn Water Efficiency points in LEED® Green Building Rating System

### Material

- Premium metal construction for durability and reliability
- KOHLER® finishes resist corrosion and tarnishing

### Installation

- Widespread or remote valve

### Required Products/Accessories

K-77974-4 Lever bathroom sink faucet handles

or

K-77974-8 Oyl bathroom sink faucet handles

or

K-77974-9 Industrial bathroom sink faucet handles

or

K-77963-8A Rocker bathroom sink faucet handle

### Recommended Products/Accessories

K-23726 Drain treatment

K-23723 Faucet cleaner

K-78372 18" Towel Bar

K-78373 24" Towel Bar

K-78375 24" Double Towel Bar

K-78377 Hand Towel Arm

K-78378 Robe Hook

K-78379 Double Towel Arm

K-78382 Pivoting toilet paper holder

K-78383 Vertical toilet paper holder

K-78384 Covered double toilet paper holder



### Codes/Standards

ASME A112.18.1/CSA B125.1

NSF/ANSI/CAN 61

NSF/ANSI/CAN 372

All applicable US Federal and State material regulations

DOE - Energy Policy Act 1992

EPA WaterSense®

California Energy Commission (CEC)







IAPMO Certification

### KOHLER® Faucet Lifetime Limited Warranty

See website for detailed warranty information.

### Available Colors/Finishes

*Color tiles intended for reference only.*

Color	Code	Description
	CP	Polished Chrome
	SN	Vibrant® Polished Nickel
	AF	Vibrant® French Gold
	BN	Vibrant® Brushed Nickel
	BV	Vibrant® Brushed Bronze
	BL	Matte Black
	2MB	Vibrant® Brushed Moderne Brass
	TT	Vibrant Titanium

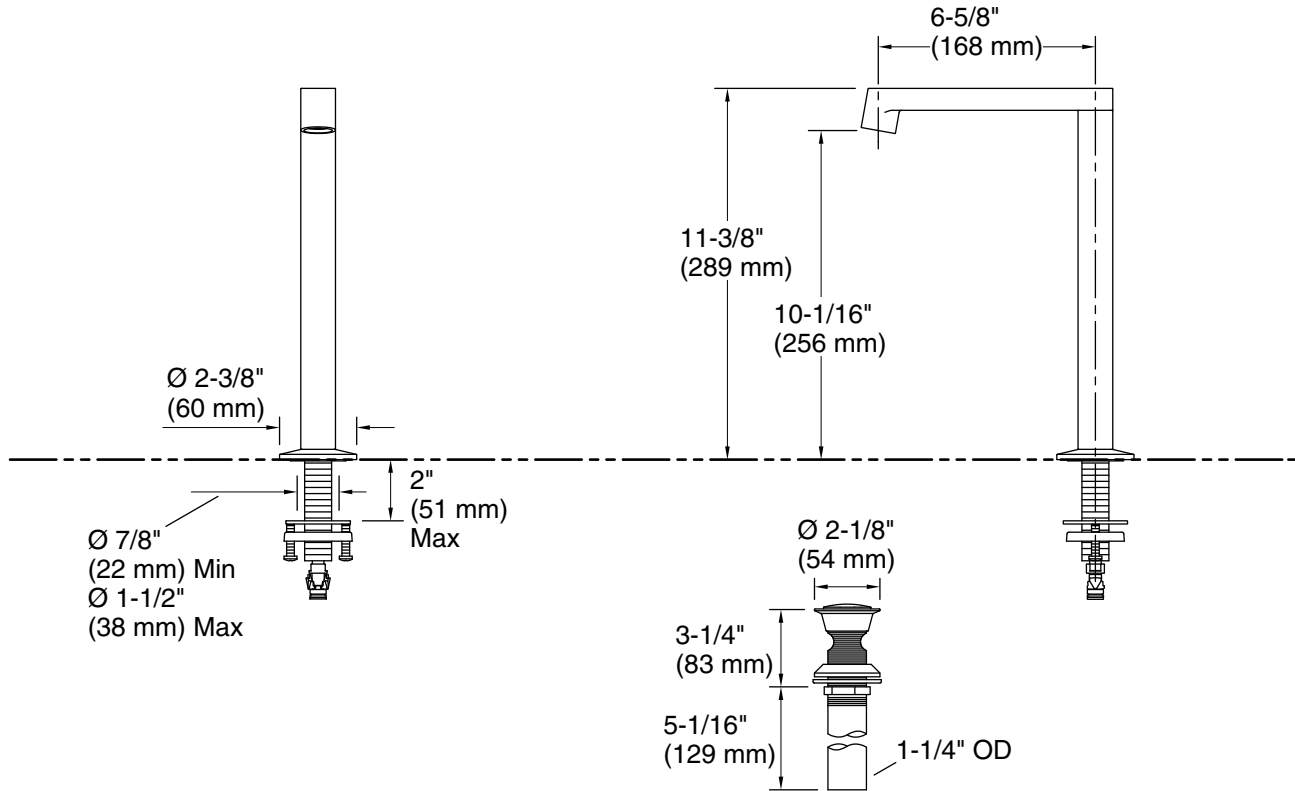

### Technical Information

All product dimensions are nominal.

#### Faucet:

Flow rate: 1.2 gal/min (4.5 l/min)

Drain included: Yes

Drain with overflow: Yes

#### Spout:

Spout reach:  $6\text{-}5/8\text{''}$  (169 mm)

#### Handshower:

Rated maximum flow: 0 gal/min (0 l/min)

### Notes

Install this product according to the installation instructions.