

### Features

- Fits minimum 36" (914 mm) apron sink base cabinet
- Single bowl
- 9" (229 mm) depth provides generous workspace
- Self-Trimming® apron overlaps cabinet face for easy installation and beautiful results
- Bowl slopes toward drain to minimize water pooling
- Offset drain increases workspace in the sink and storage space underneath
- Sink drain and strainer sold separately

### Material

- KOHLER® enameled cast iron
- Acid-resistant enamel finish

### Installation

- Undermount
- For 36" (914 mm) apron-front cabinetry

### Required Products/Accessories

K-8801 Sink drain and strainer with tailpiece

or

K-8799 Sink drain and strainer basket

or

K-11352 Disposal Flange with Stopper

K-6237 Left-Bowl Sink Rack

K-6255 Right-Bowl Sink Rack

### Recommended Products/Accessories

K-23726 Drain treatment

K-23725 Cast iron cleaner

K-6239 Colander with Cutting Board

### Optional Products/Accessories

K-9000 P-Trap

### Included Components

K-6194 Utility Rack With Soaking Cup

K-6246 Maple hardwood cutting board



### Codes/Standards







ASME A112.19.1/CSA B45.2

### KOHLER® Enameled Cast Iron Kitchen and Bathroom Sink Lifetime Limited Warranty

See website for detailed warranty information.

### Available Colors/Finishes

*Color tiles intended for reference only.*

| Color   | Code | Description   |
|---|------|---------------|
|  | 0    | White         |
|  | FF   | Sea Salt™     |
|  | 96   | Biscuit       |
|  | NY   | Dune          |
|  | 95   | Ice™ Grey     |
|  | 58   | Thunder™ Grey |
|  | 7    | Black Black™  |
|  | TRF  | Truffle       |

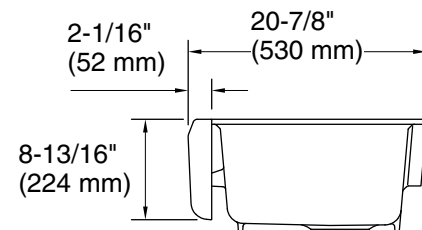
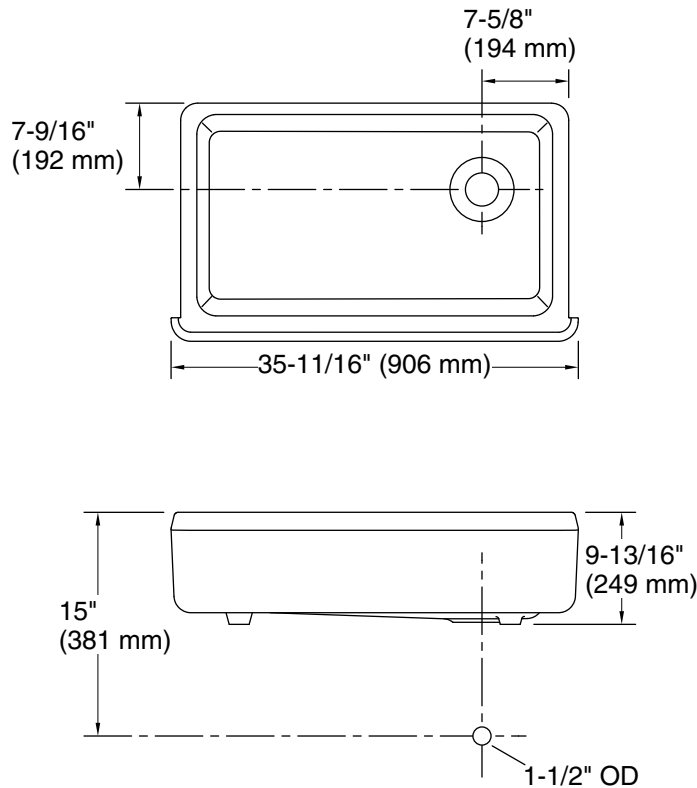

## Technical Information

All product dimensions are nominal.

Basin configuration: Single Bowl  
 Min. base cabinet width: 36" (914 mm)

Bowl area (Only): Length: 30-1/4" (769 mm)  
 Width: 15-13/16" (402 mm)  
 Bowl depth: 9" (229 mm)  
 Water depth: 9" (229 mm)

Drain hole: 3-7/8" (98 mm)

Template: Undermount, 1398641-7, required, included  
 Apron-front, 1157001, required, included

## Notes

Install this product according to the installation instructions.

Install this product according to the installation instructions.