

### Features

- A single handle controls both on/off activation and temperature setting
- 4-11/16" (101 mm) spout reach
- 0.5 gpm (1.9 lpm) maximum flow rate at 60 psi (4.14 bar)
- KOHLER® ceramic disc valves exceed industry longevity standards for a lifetime of durable performance
- Metal pop-up drain with lift rod and tailpiece
- Coordinates with other products in the Parallel collection

### Material

- Premium metal construction for durability and reliability
- KOHLER® finishes resist corrosion and tarnishing

### Installation

- Single hole
- Preattached flexible supply lines simplify installation

### Recommended Products/Accessories

- K-23726 Drain treatment
- K-23723 Faucet cleaner



ADA

CSA B651

OBC

### Codes/Standards







ASME A112.18.1/CSA B125.1  
 NSF/ANSI/CAN 61  
 NSF/ANSI/CAN 372  
 All applicable US Federal and State material regulations  
 DOE - Energy Policy Act 1992  
 California Energy Commission (CEC)  
 ADA  
 ICC/ANSI A117.1  
 CSA B651  
 OBC  
 IAPMO Certification

### KOHLER® Faucet Lifetime Limited Warranty

See website for detailed warranty information.

### Available Colors/Finishes

*Color tiles intended for reference only.*

Color	Code	Description
	CP	Polished Chrome
	SN	Vibrant® Polished Nickel
	AF	Vibrant® French Gold
	BN	Vibrant® Brushed Nickel
	BV	Vibrant® Brushed Bronze
	BL	Matte Black
	2MB	Vibrant® Brushed Moderne Brass
	TT	Vibrant Titanium

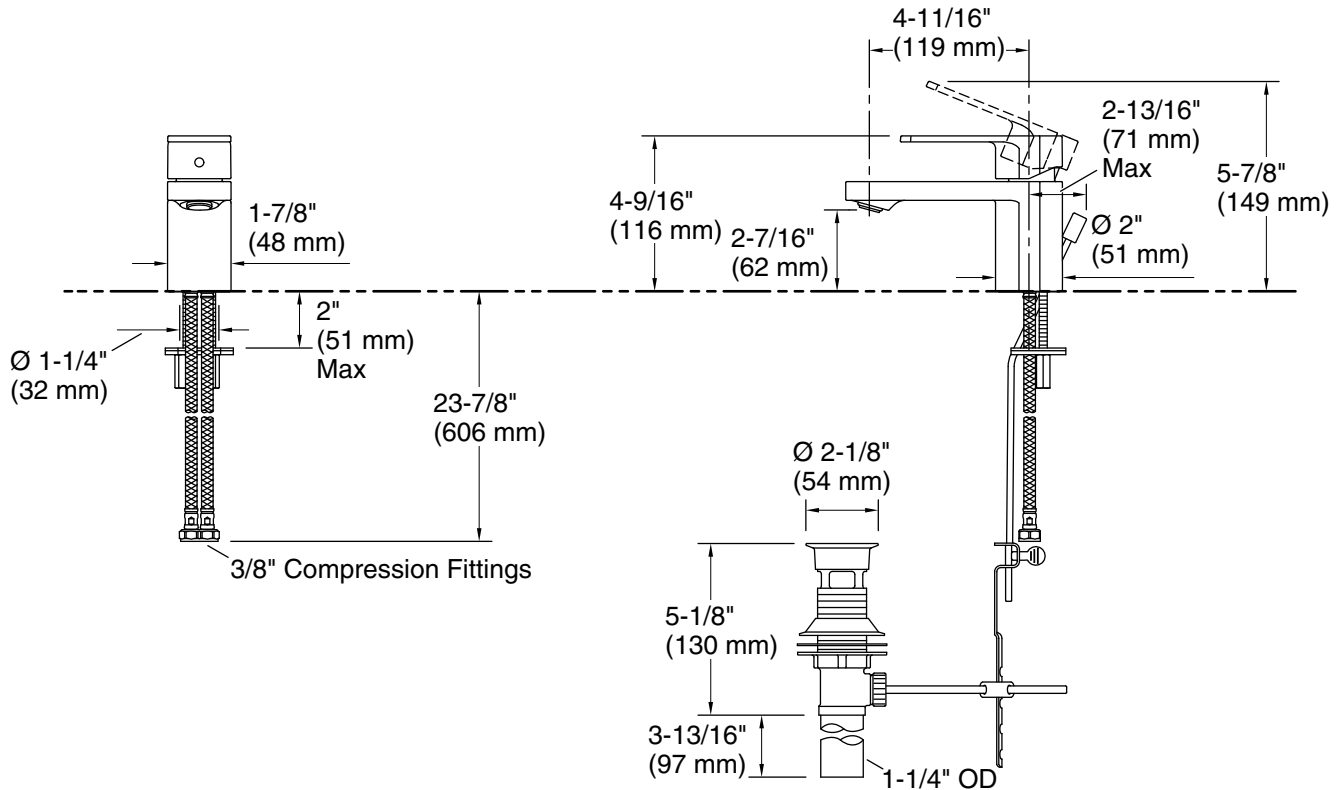

### Technical Information

All product dimensions are nominal.

#### Faucet:

Flow rate: 0.5 gal/min (1.9 l/min)

Drain included: Yes

#### Spout:

Spout reach: 4-11/16" (119 mm)

#### Handshower:

Rated maximum flow: 0 gal/min (0 l/min)

### Notes

Install this product according to the installation instructions.

ADA compliant for handles only.

ADA, OBC, CSA B651 compliant when installed to the specific requirements of these regulations.