

Features

- Unique rainhead design reveals faucet stream flowing into wide-nozzle face plate, releasing a thick curtain of water
- Full Coverage Rain uses gravity to deliver a soft flow of water, providing a gentle spray experience reminiscent of natural rainfall
- Self-leveling ball joint keeps rainhead parallel to the ground for steady coverage
- Optimized sprayface for maximum performance
- 2.5 gpm (9.5 lpm) maximum flow rate at 45 psi (3.1 bar)

Material

- Premium material construction for durability and reliability
- KOHLER® finishes resist corrosion and tarnishing

Installation

- 1/2" -14 NPT connection
- Requires ceiling-mount single-function rainhead arm and flange (sold separately)

Required Products/Accessories

K-26319 3" ceiling-mount single-function rainhead arm and flange

or

K-26320 6" ceiling-mount single-function rainhead arm and flange

or

K-26321 12" ceiling-mount single-function rainhead arm and flange

or

K-26322 15-1/2" wall-mount single-function rainhead arm and flange

or

K-26307 19" wall-mount single-function rainhead arm and flange

Recommended Products/Accessories

K-23723 Faucet cleaner



Codes/Standards







ASME A112.18.1/CSA B125.1
DOE - Energy Policy Act 1992
IAPMO Certification

KOHLER® Faucet Lifetime Limited Warranty

See website for detailed warranty information.

Available Colors/Finishes

Color tiles intended for reference only.

Color	Code	Description
	CP	Polished Chrome
	SN	Vibrant® Polished Nickel
	AF	Vibrant® French Gold
	BN	Vibrant® Brushed Nickel
	BV	Vibrant® Brushed Bronze
	BL	Matte Black
	2MB	Vibrant® Brushed Moderne Brass
	TT	Vibrant Titanium

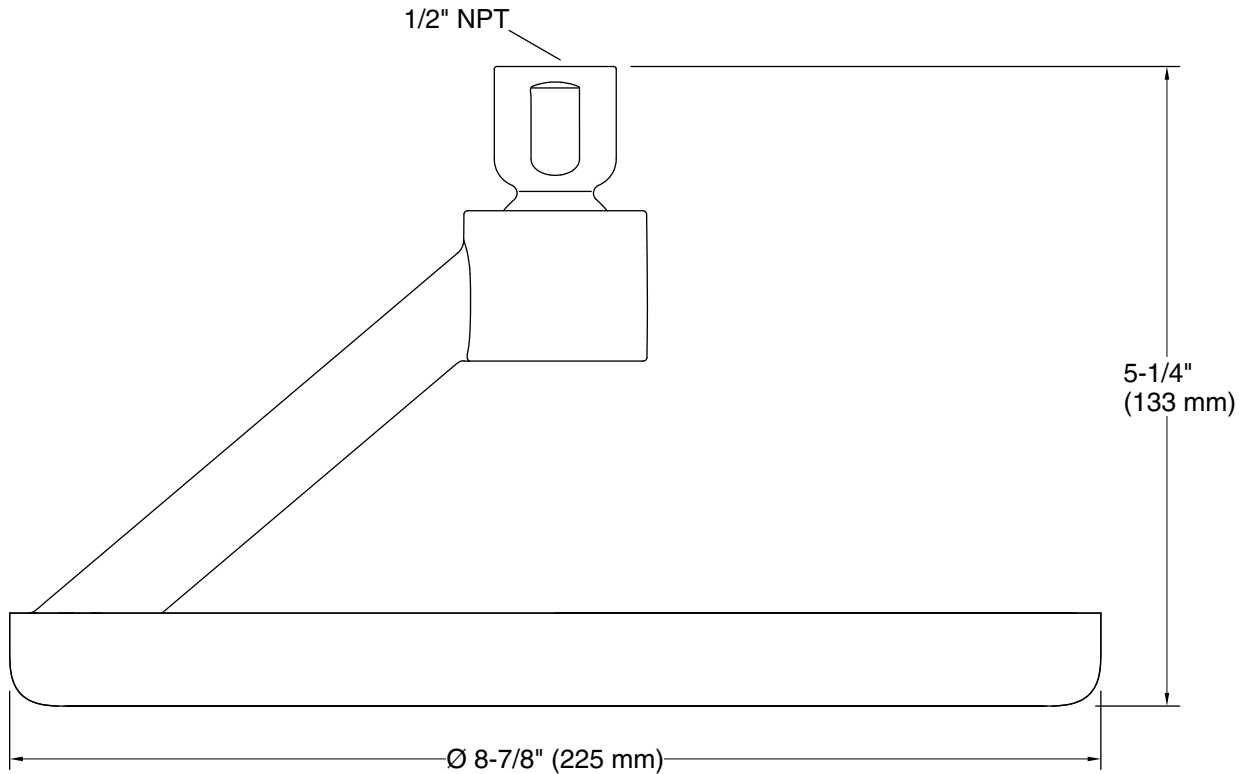

Technical Information

All product dimensions are nominal.

Handshower:

Rated maximum flow: 0 gal/min (0 l/min)

Showerhead/Body Spray:

Rated maximum flow: 2.5 gal/min (9.5 l/min)