

Features

- 24" (610 mm) bar
- Provides minimum 300 lb load capacity
- Coordinates with transitional-style KOHLER® faucets and showering components

Material

- Premium metal construction for durability and reliability
- KOHLER® finishes resist corrosion and tarnishing



Codes/Standards

None Applicable

KOHLER® One-Year Limited Warranty

See website for detailed warranty information.

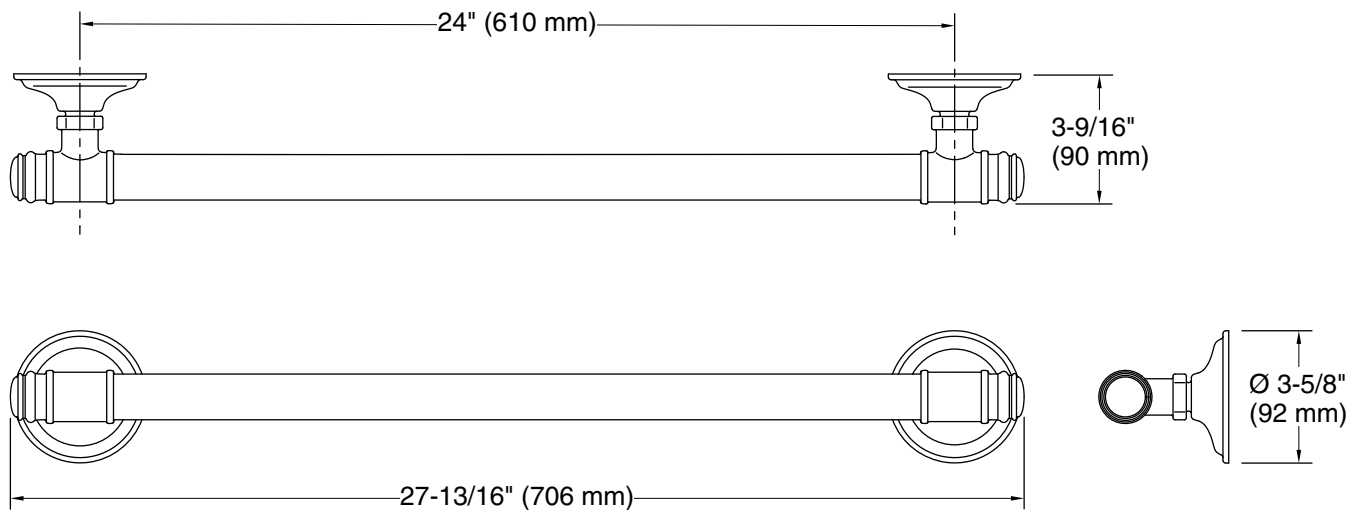

Technical Information

All product dimensions are nominal.

Material: Zinc, Stainless Steel

Notes

Measure your actual product for roughing-in details.

WARNING: Risk of personal injury. The wall plates on the grab bar must be mounted to a brace between the wall studs. This will ensure that the weight of the user is adequately supported.