

### Features

- A single handle controls both on/off activation and temperature setting
- Valve included
- KOHLER® ceramic disc valves exceed industry longevity standards for a lifetime of durable performance
- Part of the Occasion bathroom faucet and accessory collection

### Material

- Premium metal construction for durability and reliability
- KOHLER® finishes resist corrosion and tarnishing

### Installation

- Deck-mount

### Required Products/Accessories

K-27017 Deck-mount bath spout with Straight design

or

K-27016 Deck-mount bath spout with Cane design

### Recommended Products/Accessories

- K-23723 Faucet cleaner
- K-27060 18" towel bar
- K-27061 24" towel bar
- K-27062 24" double towel bar
- K-27063 Towel ring
- K-27064 Vertical toilet paper holder
- K-27065 Pivoting toilet paper holder
- K-27069 Robe hook
- K-27128 Toilet paper holder with tray



### Codes/Standards

ASME A112.18.1/CSA B125.1

ADA

ICC/ANSI A117.1

CSA B651

OBC









IAPMO Certification

### KOHLER® Faucet Lifetime Limited Warranty

See website for detailed warranty information.

### Available Colors/Finishes

*Color tiles intended for reference only.*

Color	Code	Description
	CP	Polished Chrome
	SN	Vibrant® Polished Nickel
	AF	Vibrant® French Gold
	BN	Vibrant® Brushed Nickel
	BV	Vibrant® Brushed Bronze
	BL	Matte Black
	2MB	Vibrant® Brushed Moderne Brass
	BMB	Matte Black with Moderne Brass
	TT	Vibrant Titanium

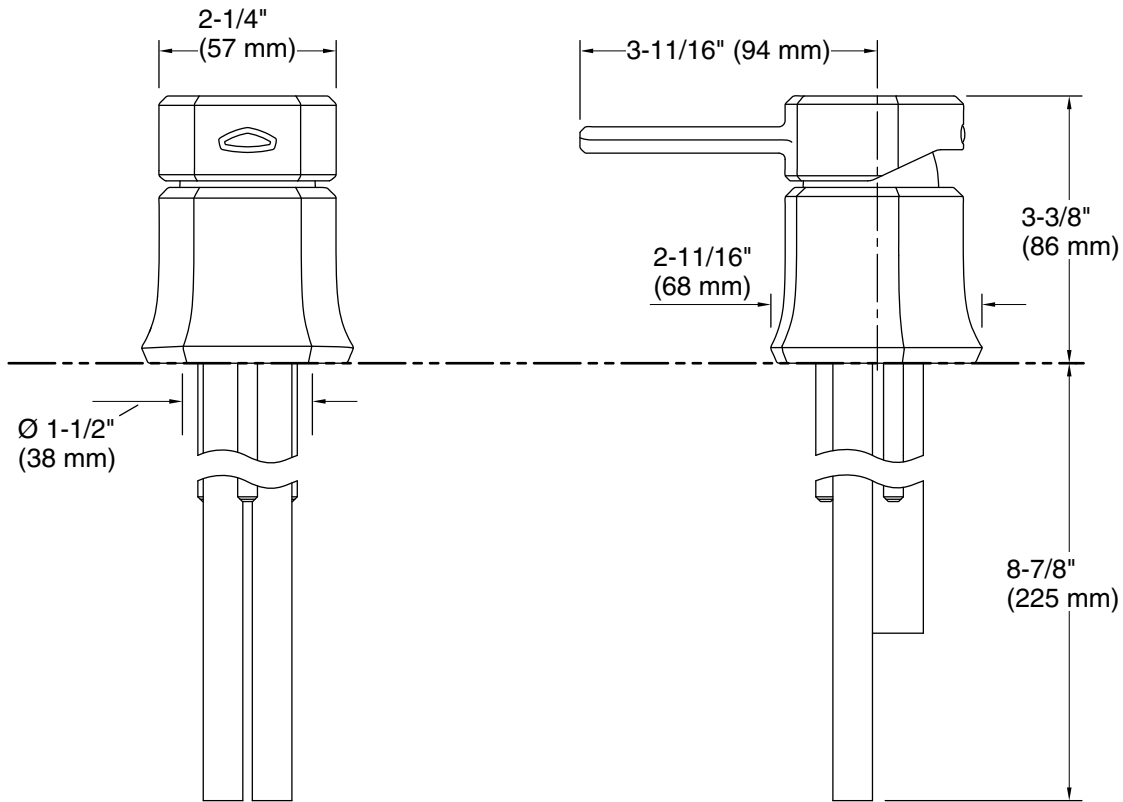

### Technical Information

All product dimensions are nominal.

Drain included: No

### Handshower:

Rated maximum flow: 0 gal/min (0 l/min)

### Notes

ADA, OBC, CSA B651 compliant when installed to the specific requirements of these regulations.