

Features

- Single-function handshower delivers a full, consistent spray, regardless of water pressure
- Full Coverage with Katalyst™ air-induction technology delivers a drenching spray experience, ideal for rinsing shampoo from hair
- MasterClean™ sprayface features an easy-to-clean surface that withstands mineral buildup and maximizes spray performance
- Optimized sprayface for maximum performance
- Part of the Occasion bathroom faucet and accessory collection

Material

- Premium material construction for durability and reliability
- KOHLER® finishes resist corrosion and tarnishing

Technology

- Katalyst® air-induction technology infuses water with air, creating bigger drops for a more powerful spray

Installation

- G 1/2 inlet and outlet
- Requires shower hose (sold separately)
- Bracket or sidebar required for wall-mount installation
- Deck-mount holder required for deck-mount installation

Recommended Products/Accessories

- K-9514 60" Shower Hose
- K-8593 72" Shower Hose
- K-26309 Wall-mount handshower holder
- K-26310 Wall-mount handshower holder with supply elbow and check valve
- K-26312 32-1/8" sidebar
- K-26313 40" sidebar
- K-26314 32" deluxe sidebar with integrated water supply
- K-23723 Faucet cleaner



Codes/Standards









ASME A112.18.1/CSA B125.1
DOE - Energy Policy Act 1992
IAPMO Certification

KOHLER® Faucet Lifetime Limited Warranty

See website for detailed warranty information.

Available Colors/Finishes

Color tiles intended for reference only.

Color	Code	Description
	CP	Polished Chrome
	SN	Vibrant® Polished Nickel
	AF	Vibrant® French Gold
	BN	Vibrant® Brushed Nickel
	BV	Vibrant® Brushed Bronze
	BL	Matte Black
	2MB	Vibrant® Brushed Moderne Brass
	TT	Vibrant Titanium

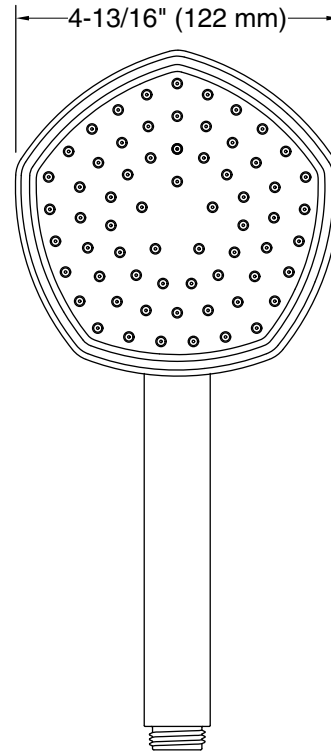
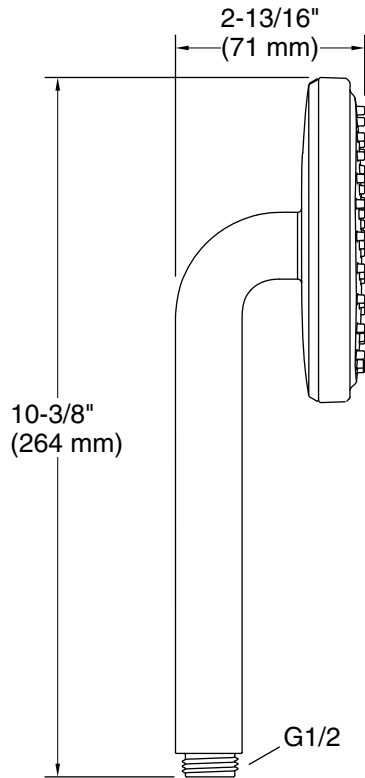

Technical Information

All product dimensions are nominal.

Handshower:

Rated maximum flow: 2.5 gal/min (9.5 l/min)

Notes

For use with automatic compensating valves rated at 2.5 gal/min (9.5 l/min) or less.