

## Features

- 30" (762 mm) minimum base cabinet width
- Single bowl
- 12" (305 mm) depth provides generous workspace
- Offset drain increases workspace in the sink and storage space underneath
- Accessories stack and slide on ledges for a custom arrangement
- Wash bin features a deep tub, perfect for washing and soaking household items
- Stainless steel utility rack fits securely within the wash bin
- Matte finish offers rich, dimensional color
- No faucet holes; requires wall- or deck-mount faucet

## Material

- KOHLER Neoroc® composite is durable and built to withstand day-to-day cleaning tasks
- Solid color throughout the sink
- Heat-resistant up to 750°F
- Scratch-, stain-, chip-, and thermal-shock-resistant

## Installation

- Undermount
- Easy to install in a one-person, single-day project

## Recommended Products/Accessories

- K-8801 Sink drain and strainer with tailpiece
- K-8799 Sink drain and strainer basket
- K-23726 Drain treatment
- K-23725 Cast iron cleaner

## Optional Products/Accessories

- K-11352 Disposal Flange with Stopper
- K-9000 P-Trap

## Included Components

- K-27788 Stainless steel utility rack
- K-27789 Wash bin



## Codes/Standards







CSA B45.5/IAPMO Z124  
IAPMO Certification

## KOHLER® Neoroc® Sinks Lifetime Limited Warranty

See website for detailed warranty information.

## Available Colors/Finishes

*Color tiles intended for reference only.*

Color	Code	Description
	CM6	Matte White
	CM7	Matte Graphite
	CM2	Matte Brown
	CM3	Matte Taupe
	CM1	Matte Black
	CM4	Matte Grey

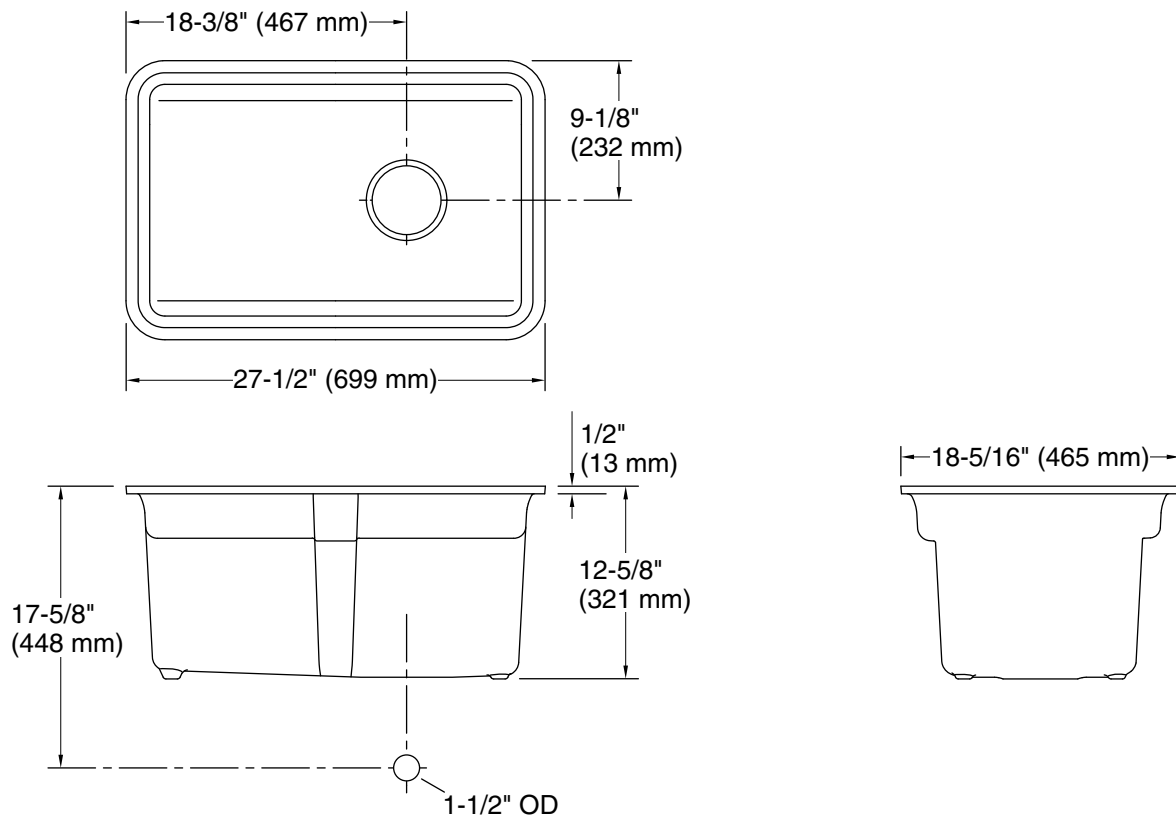

## Technical Information

All product dimensions are nominal.

Basin configuration: Single Bowl  
 Min. base cabinet width: 30" (762 mm)

Bowl area (Only): Length: 24-3/8" (620 mm)  
 Width: 15-3/8" (391 mm)  
 Bowl depth: 12" (305 mm)  
 Water depth: 12" (305 mm)

With overflow: No

Drain hole: 3-7/8" (98 mm)

Template: Undermount, 1311528-7, required, included

## Notes

Install this product according to the installation instructions.

**NOTICE:** Countertop manufacturer or cutter must use the cut-out template provided with the product, or a current one provided by Kohler Co. (call 1-800-4-KOHLER). Kohler Co. is not responsible for cutout errors when the incorrect cut-out template is used.