

Features

- Touchless on/off with a wave of your hand or an object such as a pan
- Response® technology uses a state-of-the-art motion sensor for reliable touchless activation
- Two-function pull-down sprayhead with touch control allows you to switch between aerated and Sweep® sprays
- Sweep® spray features specially angled nozzles that form a wide, powerful blade of water to sweep your dishes and sink clean
- DockNetik® secure docking system locks sprayhead into place when not in use
- ProMotion® technology's light, quiet braided hose and swiveling ball joint make the pull-down sprayhead easier and more comfortable to use
- MasterClean™ sprayface features an easy-to-clean surface that withstands mineral buildup and maximizes spray performance
- High-arch spout offers vertical clearance for tall cookware and pitchers
- Single lever handle makes adjusting water temperature easy with one hand
- KOHLER ceramic disc valves exceed industry longevity standards by over two times, ensuring durable performance for life
- 1.5 gpm (5.7 lpm) maximum flow rate at 60 psi (4.14 bar)
- Temperature memory allows faucet to be turned on and off at the temperature set during prior usage

Material

- Premium metal construction for durability and reliability
- KOHLER finishes resist corrosion and tarnishing

Installation

- For single-hole or three-hole installation (escutcheon plate sold separately)
- Flexible supply lines simplify installation

Recommended Products/Accessories

K-23723 Faucet cleaner

Optional Products/Accessories

K-24461 Three-hole kitchen faucet escutcheon



ADA CSA B651

Codes/Standards











ASME A112.18.1/CSA B125.1
NSF/ANSI/CAN 61
NSF/ANSI/CAN 372
DOE - Energy Policy Act 1992
California Energy Commission (CEC)
ADA
ICC/ANSI A117.1
CSA B651

KOHLER® Electronic Faucets, Valves, and Controls Five-Year Limited Warranty

See website for detailed warranty information.

Available Colors/Finishes

Color tiles intended for reference only.

| Color | Code | Description |
|---|------|--------------------------------|
|  | CP | Polished Chrome |
|  | SN | Vibrant® Polished Nickel |
|  | AF | Vibrant® French Gold |
|  | VS | Vibrant® Stainless |
|  | BV | Vibrant® Brushed Bronze |
|  | BL | Matte Black |
|  | 2MB | Vibrant® Brushed Moderne Brass |
|  | BGP | Brushed Graphite |
|  | TT | Vibrant Titanium |
|  | RMR | Matte Black with Moderne |

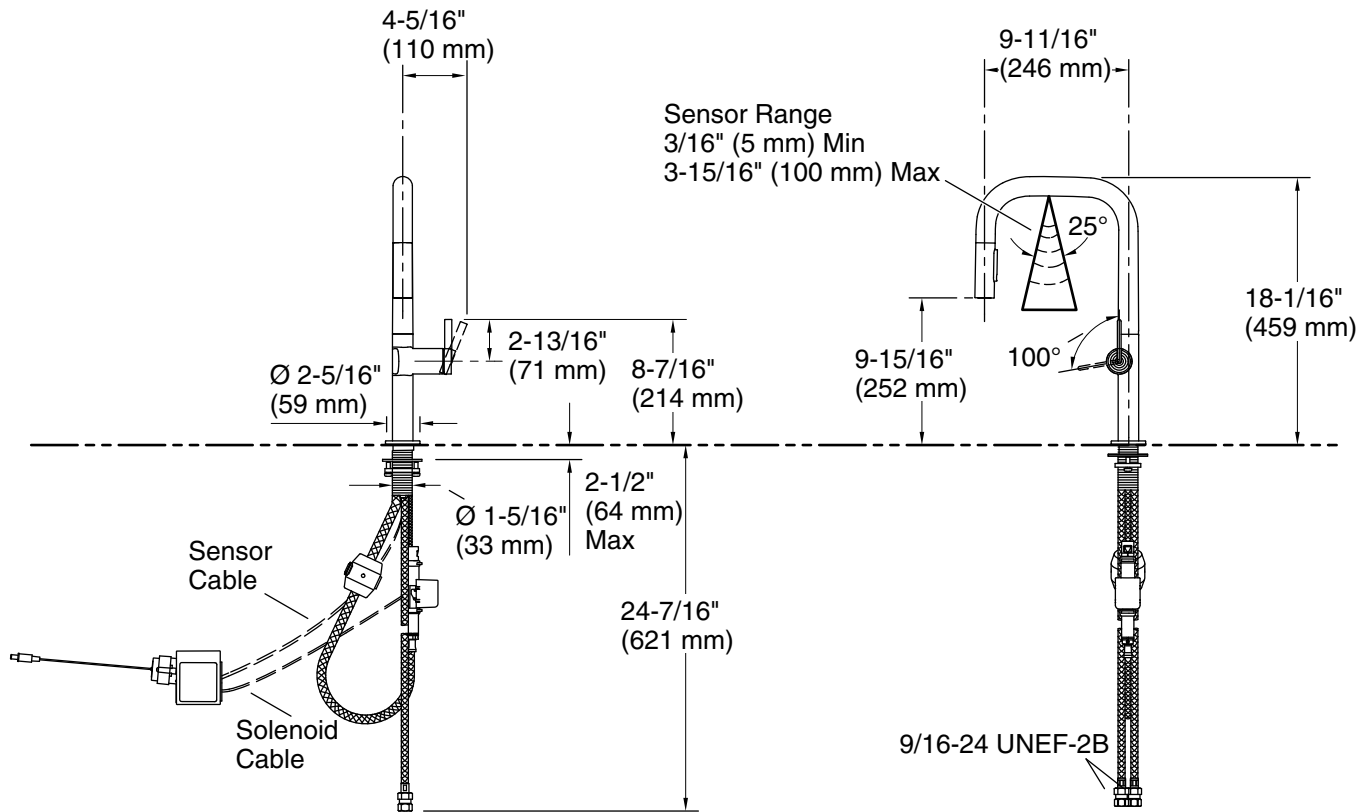

Technical Information

All product dimensions are nominal.

Power source: Plug - AC, included
 Faucet flow rate: 1.5 gal/min (5.7 l/min)
 Drain included: No

Spout:

Spout reach: 9-11/16" (246 mm)

Notes

Install this product according to the installation instructions.

ADA compliant for faucet handles only
 ADA, CSA B651 compliant when installed to the specific requirements of these regulations.