



Iron/Impressions®

31" Enameled cast iron vanity top with integrated rectangular sink
K-3049-1

Features

- Single faucet hole
- Sloped-wall rectangular basin

Material

- KOHLER® enameled cast iron

Installation

- Vanity top

Recommended Products/Accessories

- K-9018 P-Trap
- K-23726 Drain treatment
- K-23725 Cast iron cleaner



Codes/Standards











ASME A112.19.1/CSA B45.2
IAPMO Certification

KOHLER® Enameled Cast Iron Kitchen and Bathroom Sink Lifetime Limited Warranty

See website for detailed warranty information.

Available Colors/Finishes

Color tiles intended for reference only.

Color	Code	Description
	0	White
	FF	Sea Salt™
	96	Biscuit
	NY	Dune
	95	Ice™ Grey
	FT	Basalt
	7	Black Black™
	GRL	Grey Lavender
	DGB	Indigo Blue
	PLM	Black Plum

1-800-4KOHLER (1-800-456-4537)

Kohler Co. reserves the right to make revisions without notice to product specifications.

For the most current Specification Sheet, go to www.kohler.com USA or www.kohler.ca Canada

10-22-2024 20:37 - US/CA

THE BOLD LOOK
OF **KOHLER**®

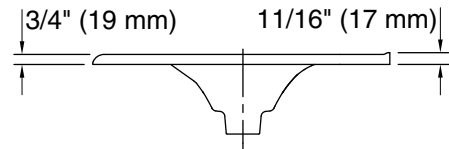
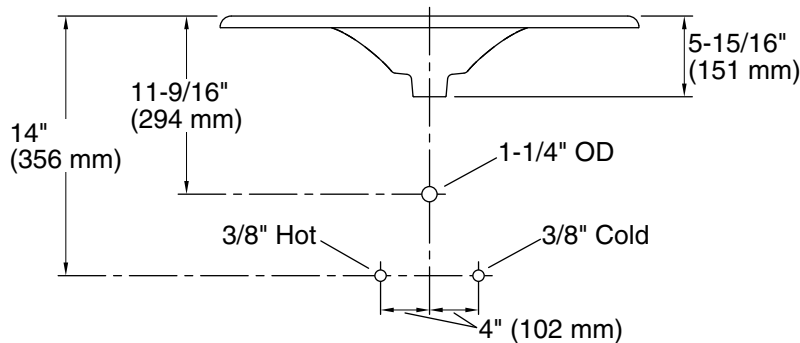
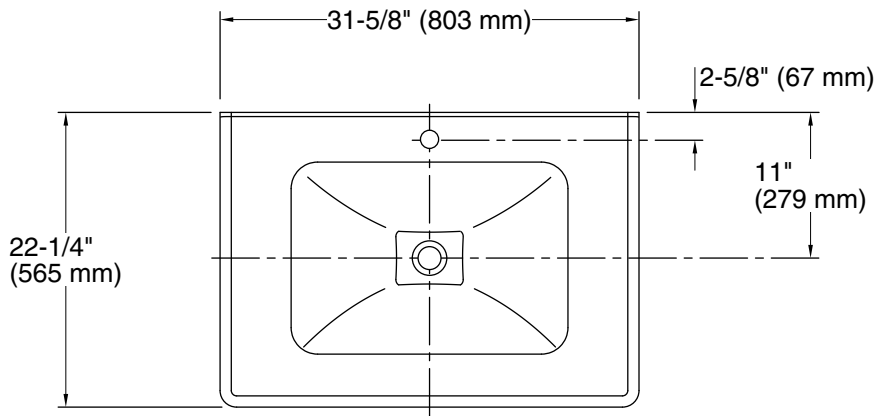

Technical Information

All product dimensions are nominal.

Basin configuration:	Single Bowl
Bowl area (Only):	Length: 20-7/8" (530 mm) Width: 14-1/2" (368 mm) Water depth: 4" (102 mm)
Number of deck holes:	1
Faucet hole(s):	1-3/8" (35 mm)
Drain hole:	1-3/4" (44 mm)

Notes

Install this product according to the installation instructions.

NOTE: When selecting a faucet for this bathroom sink, ensure the faucet has a spout reach of 4-1/2" (114 mm) to 5" (127 mm) and has a spout height of 3" (76 mm) to 6" (152 mm).

Product does not have an overflow.