

FINISHED WALL / BACK SPLASH
完工墙面/防溅挡板

Note: before cutting countertop
Allow for handle clearance.
注意: 在切割台面之前, 请留出
安装龙头的空间。

CENTERLINE OF FITTING(For K-31701T/K-31703T)
安装中线(适用于K-31701T/K-31703T)

KOHLER

**K-31701T/K-31703T/K-31703T-1
K-30705T-1
CHALICE SLEEK 乔灵**

**VESSEL W/O DECK
椭圆形时尚台盆
CUT-OUT TEMPLATE / INSTALLATION INSTRUCTIONS
切割图/安装说明书**

BEFORE YOU BEGIN

- Observe all local plumbing and building codes.
- Inspect the waste and supply tubing; replace if necessary.
- Prior to installation, unpack the new lavatory and carefully inspect it for damage. Return the lavatory to its protective carton until you are ready to install it.
- For replacement installations, make sure the existing cutout is the same or smaller size as the new lavatory.
- Use the template supplied with the lavatory to mark correct size cutout.
- Kohler lavatory is made according to American National Standard that it can match the American lavatory fittings. Any other lavatory fittings may not fit for Kohler lavatory.
- Fixture dimensions are nominal and conform to tolerances established by ASME Standards (A112.19.2-2018).
- The product complies with GB/T 6952-2015.
- Please purchase 880089-CP as accessory to match with draw bar faucet of Kohler brand.

**TOOLS AND MATERIALS
(Not Supplied)**

- Template(supplied)
- Safety glasses
- Pencil
- Scissors
- Tape measure
- Putty knife
- Plumbers putty
- Hacksaw
- Keyhole saw or saber saw
- Drill (13mm or 1/2" dia. drill bit or larger)
- Adjustable wrench
- Pipe wrench
- Tubing cutter

安装之前

- 留意当地所有给排水及建筑规定。
- 检查污水管及供水管, 如有需要请更换。
- 安装之前, 先开启新脸盆的包装, 并小心检验新脸盆是否有损坏, 再将脸盆放回包装盒内, 到安装时才取用。
- 若为更换新脸盆, 须确保现有的柜台孔口与新脸盆的切割位相同或较后者小。
- 请使用同时印在此说明书上的切割图, 标记正确之切割位。
- 科勒洗脸盆是根据美国标准制造的, 与美式洗脸盆配件相配。其它洗脸盆配件可能与之不相配。
- 部件尺寸为标称值, 误差符合美国ASME标准(A112.19.2-2018)。
- 本产品符合GB/T 6952-2015。
- 如压配材料请提拉杆龙头, 请另购配件880089-CP, 来配合安装。

**所需工具及物料
(不随货供应)**

- 模板(已提供)
- 护眼镜
- 炭笔
- 剪刀
- 卷尺
- 涂油灰刀
- 水管用油灰
- 钢锯
- 匙孔线锯或手提电锯
- 钻(直径为13mm钻头或更大)
- 活动扳钳
- 喉管扳钳
- 切管刀

ROUGHING-IN

Reference Value
参考值

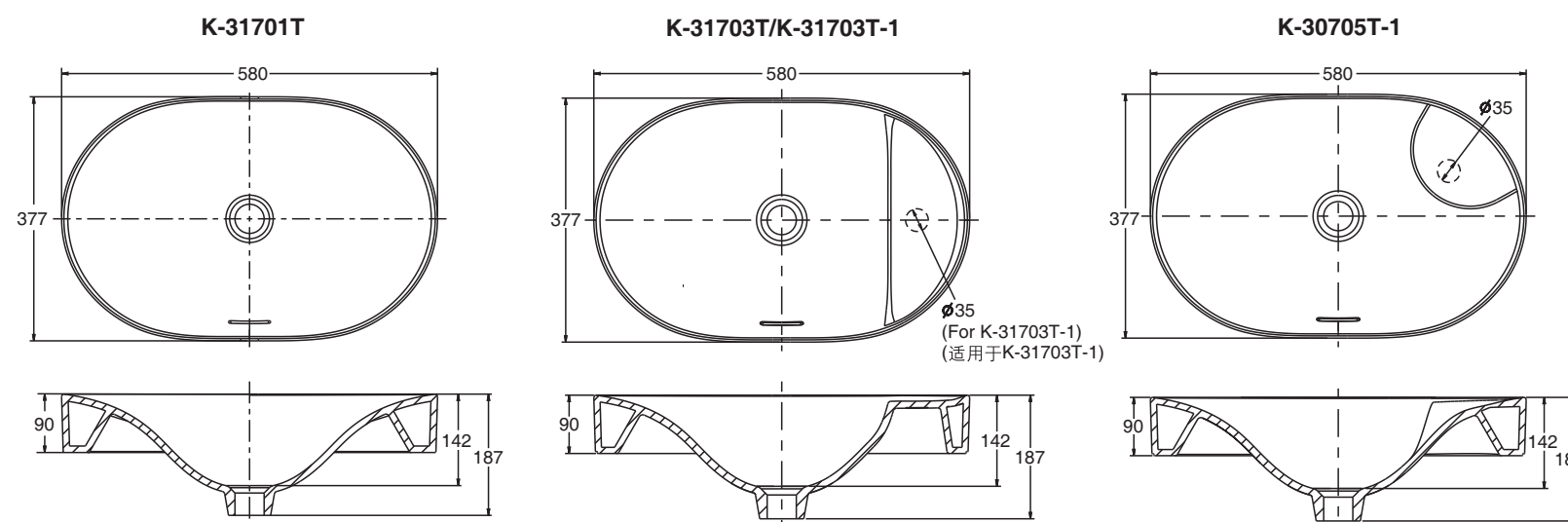

	Length 长	Width 宽	Height 高	Depth 盆深
Outer 外尺寸	580	377	187	
Inner 内尺寸	566	363		142

Kohler reserves the right to change marked dimensions without prior notice.
科勒公司保留随时变更图中标示尺寸的权利, 无需另行通知。

INSTALL NEW LAVATORY

- Cut the template on the cutout line.
- Locate the installation position. Make sure the overflow hole is on the front of the countertop and the logo is on the faucet side.
- Position the template on the countertop to ensure clearance between the lavatory, faucet, and backsplash.
- Verify cabinet clearance beneath the countertop.

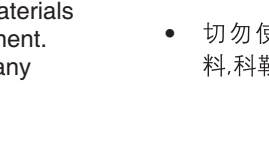
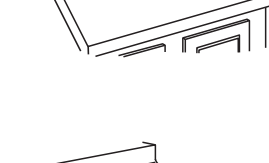
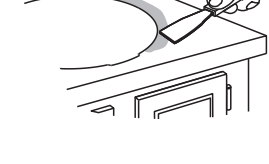
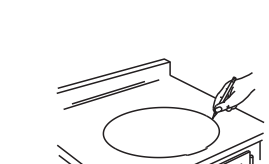
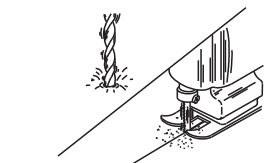
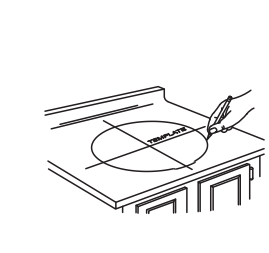
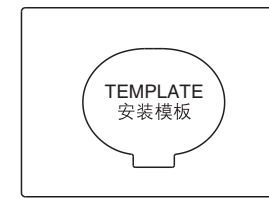

- Trace the template on the countertop with a pencil.
- Re-check the clearance between the lavatory, faucet, backsplash, and cabinet. Adjust the template accordingly.

- Drill a 13mm hole on the inside of the cutout opening.
- Cut the opening in the countertop along the inside edge of the pencil line.

- Temporarily position the lavatory in the opening, and adjust to fit.
- CAUTION: Risk of personal injury or product damage.** Large lavatories are very heavy. Get help lifting the lavatory into place.

- Trace a pencil line around the outside edge of the lavatory.
- Remove the lavatory.
- Install the faucet and drain according to the manufacturer's instructions.

- Apply two beads of sealant to the inside of the pencil line.
- Spread the sealant evenly with a putty knife.

- Carefully position the lavatory in the cutout, and press down firmly.

- CAUTION: Risk of personal injury or product damage.** Get help lifting the lavatory into place.

- Immediately wipe away any excess sealant, and fill any voids as needed.
- Verify that the lavatory has not moved out of position.

- Allow the sealant to cure for at least 30 minutes before proceeding.
- Connect the faucet supply lines.
- Connect the drain assembly.
- Open the faucet valves, and check for leakage.
- Clean up with a non-abrasive cleaner.

NOTE:

- Please use soft and wate-proof sealant.

- Do not use epoxy resin adhesive or sealing materials that will expand after concreting, such as cement. Otherwise, Kohler will not be responsible for any product damage caused by such material.

IMPORTANT CONSUMER INFORMATION (CARE AND CLEANING)

To keep your lavatory looking new, make sure you rinse it out thoroughly after each use. **DO NOT USE ABRASIVES** on this product, as they will scratch and ruin the surface. Stubborn stains, paint, or tar can be removed with turpentine or paint thinner.

Do not use the product in the water below 0°C.

- CAUTION:** Please do not use hard materials (like scouring pad) to clean product surface, especially the product logo.

RECOMMENDED DRAIN (NOT SUPPLIED):

K-30900T-0 Click Drain

安装新脸盆

- 将切割图沿切割线切出。
- 请确定产品安装位置, 注意溢水孔位置在安装台面前端, 商标位置在水龙头安装面一侧。

- 将切割图放在盥洗台上, 确保脸盆、水龙头和防溅挡板之间有足够距离。
- 查核盥洗台下的储物柜也有足够空间。

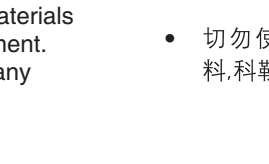
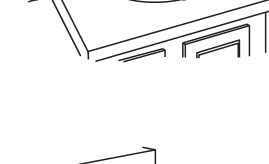
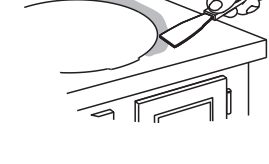
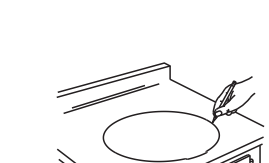
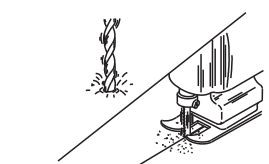
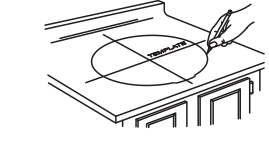

- 用炭笔沿切割图在盥洗台面划线。
- 再次检查脸盆、水龙头、防溅水板及储物柜的空间及距离。如有需要可调整切割图的位置。

- 用一个13mm的钻头, 在切割口内侧钻一个导孔。
- 沿着自切割图勾划出来的铅笔线内侧切开台面。

- 暂将脸盆放入台面开口, 校正位置。

- 小心:** 提防身体受伤或损坏产品。因大型脸盆相当重, 需找人帮您一起搬动及安放。

- 用炭笔沿脸盆外缘在盥洗台上划线。
- 然后将脸盆移开。
- 按照制造商的指引, 安装水龙头和排水管道。

- 沿炭笔导线内侧涂两遍密封胶。
- 用涂油灰刀将其抹匀。

- 小心地将脸盆置于台面切口适当位置, 向下按牢。

- 小心:** 提防身体受伤或损坏产品。需找人帮您一起搬动及安放。

- 立即擦去多余的密封胶, 如脸盆外缘与台面间有缝隙, 即用胶填满。
- 检查脸盆的位置准确。

- 最少待三十分钟, 让密封胶干透后, 方可继续进行安装。
- 连接水龙头供水管。
- 连接排水装置。
- 开启水龙头阀门, 检查有否渗滴。

- 用非腐蚀性清洁剂来清洁。

注意:

- 只能使用柔软的防水密封胶。

- 切勿使用环氧树脂或水泥等硬化后体积变大的密封材料。科勒对所有因此而引起的陶瓷破裂恕不负责。

用户须知 (护理和清洁)

为保持脸盆光洁如新, 须确保每次使用后彻底冲洗干净, 切勿使用腐蚀性的清洁剂, 以免刮伤及破坏脸盆的表面。要清除顽固污垢, 油漆或柏油, 可使用松油或油漆稀释剂。

不要在0°C以下的水环境中使用。

- 警告:** 请勿使用钢丝球等硬质材料擦洗产品表面, 特别是产品商标处。

推荐落水器 (不随货供应):

K-30900T-0 弹跳式落水

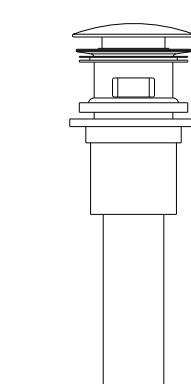

No.2 KOHLER ROAD, SANSHUI CENTRAL INDUSTRIAL PARK, LEPING TOWN, SANSHUI DIST., FOSHAN, GUANGDONG, PRC POST CODE: 528137
广东省佛山市三水区乐平镇三水中心工业园区科勒大道2号 邮编: 528137

8# MENGSHAN RD, ECONOMIC DEVELOPMENT ZONE OF HUANTAI, ZIBO, SHANDONG, CHINA POST CODE: 256410
山东省淄博市桓台经济开发区蒙山路8号 邮编: 256410

NO.1 KOHLER STREET, ECONOMIC DEVELOPMENT ZONE OF FAKU COUNTY, SHENYANG LIAONING PROVINCE, PRC POST CODE: 110400
辽宁省沈阳市法库经济开发区科勒大街1号 邮编: 110400

1443139-T01-B

© Copyright Kohler China Investment Co., Ltd. 2021
© 版权为科勒(中国)投资有限公司所有 2021