

Features

- Fast-Response® technology produces a luxurious steam shower in 60 seconds
- Power Clean™ technology offers one-touch automatic cleaning and safe maintenance
- Constant Steam feature produces steam at a consistent rate, which greatly minimizes temperature fluctuations
- Invigoration Series steam generators use approximately one gallon of water per 20-minute session, which is significantly less water than a traditional shower experience
- 894 cubic feet maximum volume rating for custom showering applications
- To ensure safety, system automatically shuts down after 20 minutes if not reactivated by user
- Requires K-5558 Invigoration Series steam generator control kit with two round steam heads or K-5549-K1 Invigoration Series digital steam adapter kit with round steam heads. Or pair K-32312 Invigoration Series steam controller or K-32311 Invigoration Series digital steam adapter with choice of two K-32310 Invigoration Series square steam heads or two K-32309 Invigoration Series linear steam heads (all sold separately)

Material

- Generator is constructed of insulated stainless steel, which maintains the temperature while ensuring case is safe to the touch



Codes/Standards

UL 499
CSA C22.2 No. 64

KOHLER® Steam Generator Three-Year Limited Warranty

See website for detailed warranty information.

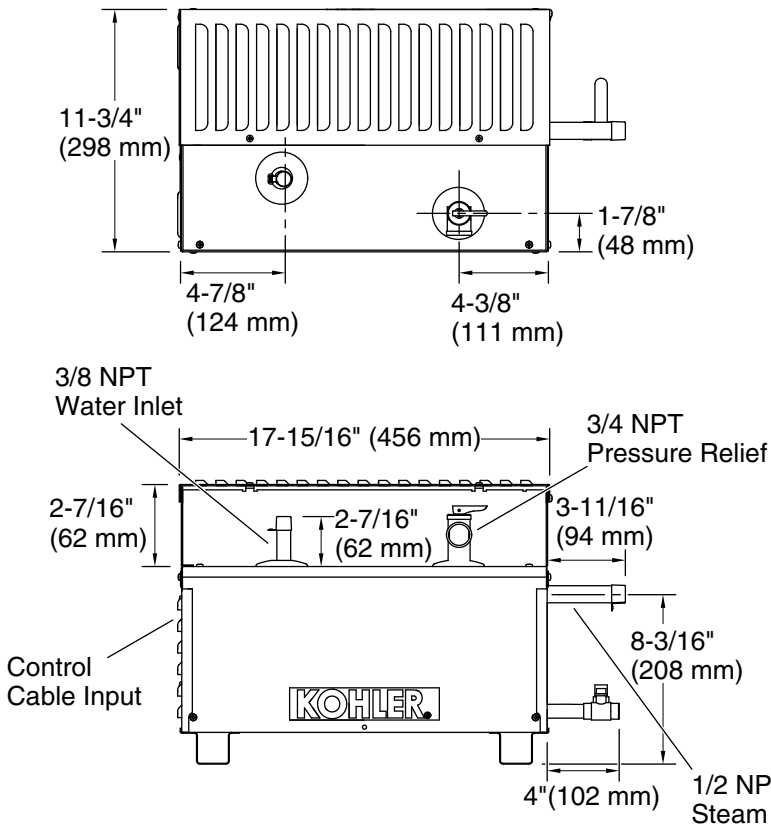

Minimum required access panel is 24" (610 mm) L x 15" (381 mm) H.

Allow for a minimum of 6" (153 mm) of space around all sides of the steam generator, with the following exception: The side opposite of the pressure relief valve may be installed against a wall.

Allow for the drain/spill pan.

KOHLER® drain pan (shown with support blocks) sold separately.

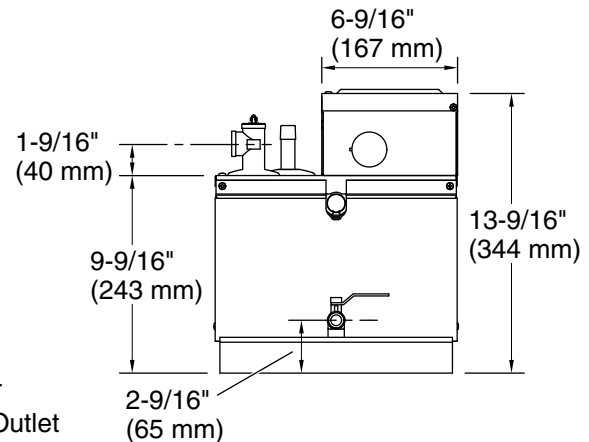

Required Electrical Service

One dedicated circuit required.

Steam Generator: 240 V, 160 A, 50/60 Hz

Technical Information

All product dimensions are nominal.

Power source: Hardwire - AC, not included

Input water recommendations:

TDS: 0-0 ppm

Hardness: 0-60 ppm

Time to Steam: 0-0 sec

Electrical component rating: Steam Generator: 240 V, 80 A, 50/60 Hz

Spout:

Max Inlet Pressure: 70 psi (482.6 kPa)

Recommended Feed Water Quality:

Water hardness: 60 ppm (3.5 gpg)

Total water alkalinity: 150 ppm (8.8 gpg)

Pressure/fixture Supply Requirements

1-800-4KOHLER (1-800-456-4537)

Kohler Co. reserves the right to make revisions without notice to product specifications.

For the most current Specification Sheet, go to www.kohler.com USA or www.kohler.ca Canada

2-16-2025 20:21 - US

Notes

To ensure proper operation, the feed water supply should be tested prior to operating the steam generator. If the feed water quality is not within the specific limit, contact a reputable water treatment company for treatment options.