

Features

- Globular glass shades are gracefully suspended from curved metal bases in artist-inspired arrangements
- A great piece for almost any space — especially in a foyer or dining room
- Requires five bulbs with G9 sockets; G9 LED bulbs recommended (sold separately)
- Suitable for damp locations, per UL 1598
- Includes installation hardware
- Fixture is dimmable when paired with dimmer switch and compatible bulbs

Material

- Manufactured with quality materials and complemented with a meticulous finishing process
- Durable finishes engineered to last and designed to coordinate with KOHLER faucet finishes



Codes/Standards

UL 1598
CSA C22.2 No. 250.0

KOHLER® Indoor Lighting Fixtures Limited Warranty

See website for detailed warranty information.

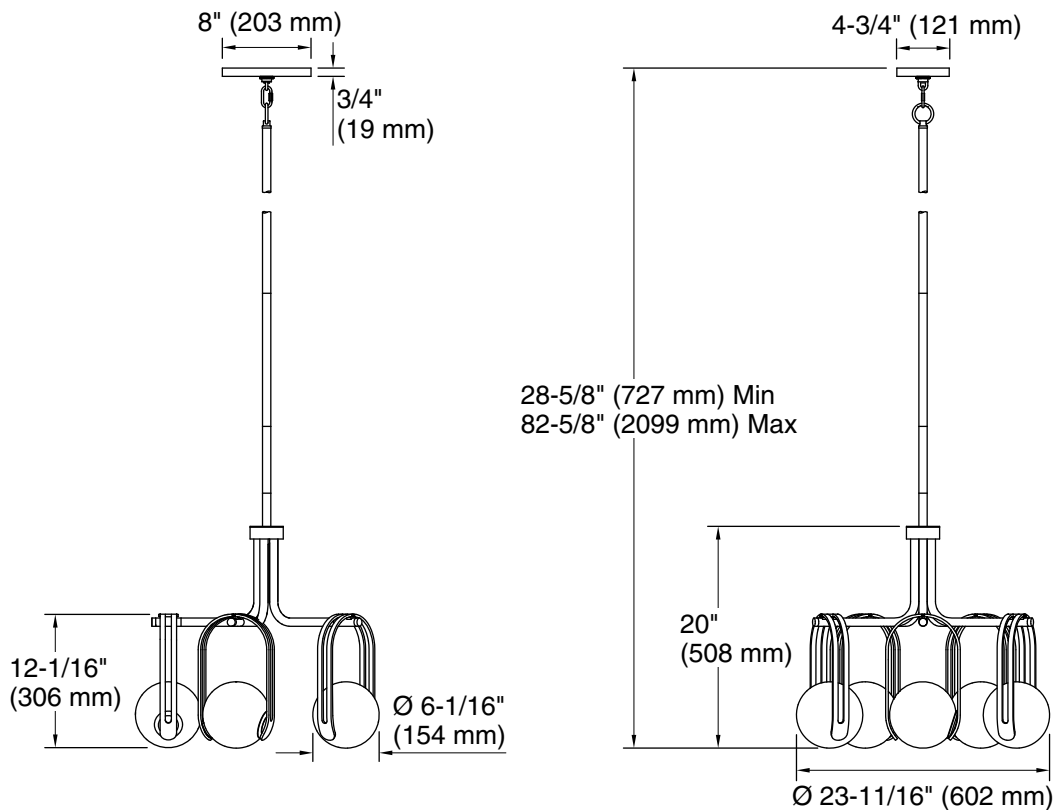

Required Electrical Service

One circuit required.

120 V, 0.208 A, 60 Hz

Technical Information

All product dimensions are nominal.

Material:	Steel, Aluminum, Glass
Number of Lights:	5
Lighting Type:	Socket-based
Socket Type:	2 pin G9
Number of Shades:	5
Shade Type:	Glass - frosted
Hanging Type:	Downrod
Downrod Detail:	2 x 18" (457 mm), 1 x 12" (305 mm), 1 x 6" (152 mm), 1 x 3" (76 mm)
Height:	28-5/8" (728 mm) - 82-5/8" (2099 mm)