

Features

- Without overflow
- 1-1/4" (32 mm) connection

Material

- Premium metal construction for durability and reliability
- KOHLER® finishes resist corrosion and tarnishing

Recommended Products/Accessories

- K-23726 Drain treatment
- K-23723 Faucet cleaner



Codes/Standards









ASME A112.18.2/CSA B125.2
IAPMO Certification

KOHLER® One-Year Limited Warranty

See website for detailed warranty information.

Available Colors/Finishes

Color tiles intended for reference only.

| Color | Code | Description |
|---|------|--------------------------------|
|  | CP | Polished Chrome |
|  | SN | Vibrant® Polished Nickel |
|  | AF | Vibrant® French Gold |
|  | BN | Vibrant® Brushed Nickel |
|  | BV | Vibrant® Brushed Bronze |
|  | BL | Matte Black |
|  | 2MB | Vibrant® Brushed Moderne Brass |
|  | TT | Vibrant Titanium |
|  | 2BL | Blackened Bronze |

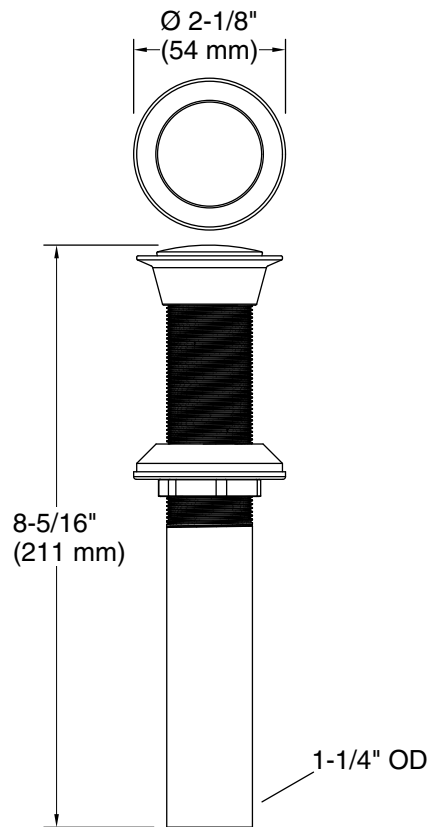

Technical Information

All product dimensions are nominal.

Material: Stainless Steel