



Anthem® | K-39014

Three-port recessed mechanical thermostatic valve

Features

- High-flow thermostatic mixing valve
- Mechanically controlled thermostatic mixing valve maintains outlet temperature throughout shower experience
- Up to 8 gpm (30.3 lpm) flow rate at 45 psi (3.1 bar) with maximum flow of 7 gpm (26.5 lpm) from one outlet
- 3/4" female NPT inlet connections
- 1/2" female NPT outlet connections
- Service stops with integral filters
- Antiscald protection
- Integrated adjustable high-temperature limit stop to control maximum water temperature
- Adjustable comfort setting (preset at approximately 104°F)
- Includes optional flow restrictor, limiting total flow to 1.75 gpm (6.6 lpm), for installations where water conservation or CEC compliance is desired



Available Colors/Finishes

Color tiles intended for reference only.

^{NA} NA Not Applicable



1-800-4KOHLER (1-800-456-4537)
Kohler Co. reserves the right to make revisions without notice to product specifications.
For the most current specification sheet, go to www.kohler.com USA or www.kohler.ca Canada.
5-31-2026 1:0 - US-CA

THE BOLD LOOK
OF **KOHLER**

Codes/Standards

ASME A112.18.1/CSA B125.1
ASSE 1016/ASME A112.1016/CSA B125.16

Valves

Included Valve: Thermostatic

Material

- Cast dezincification-resistant brass body provides long term reliability and resistance to aggressive water conditions
-

Required Products/Accessories

- K-26347-9 Three-outlet recessed mechanical thermostatic valve control
-

Warranty

See website for detailed warranty information.

KOHLER® Faucet Lifetime Limited Warranty



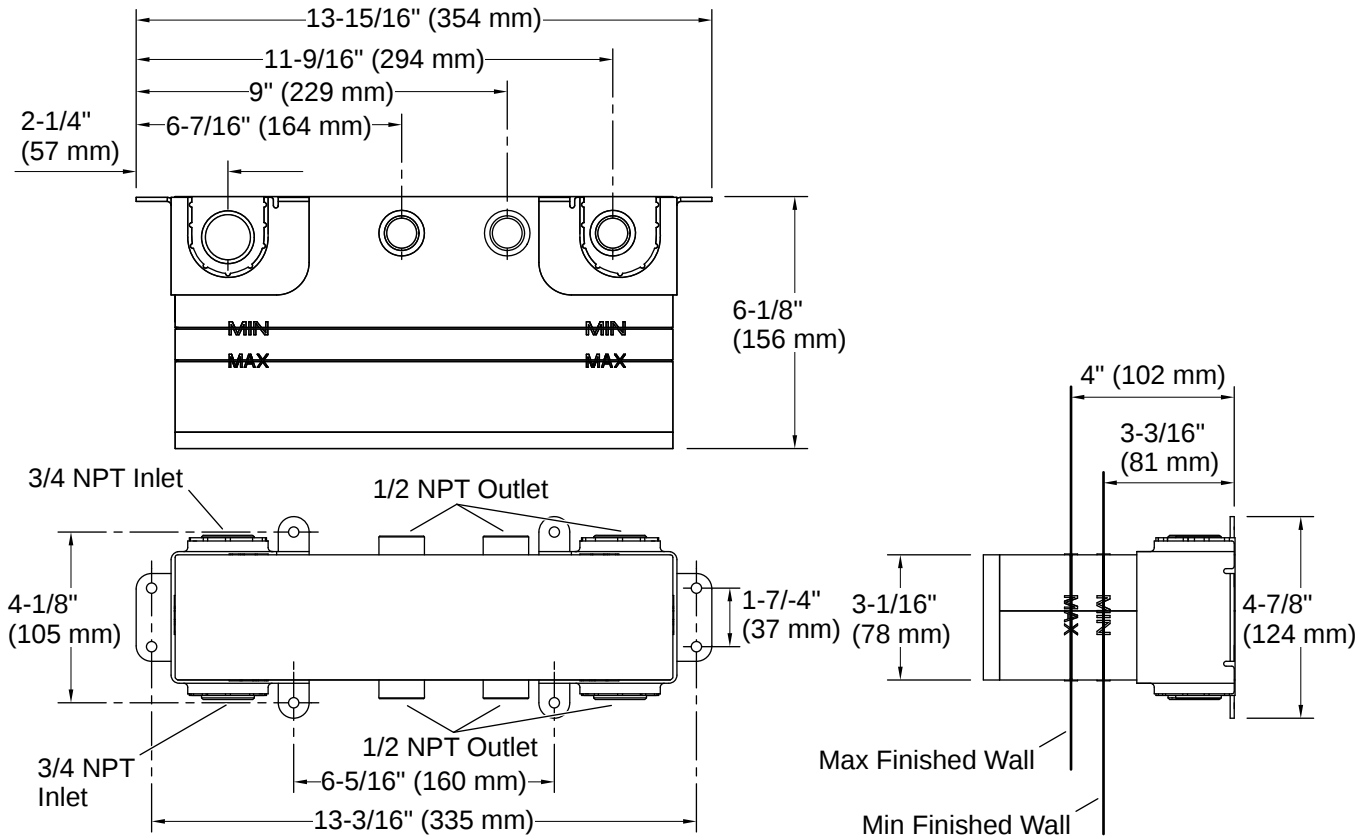

Installation

- Requires three-outlet thermostatic valve control panel trim with recessed push buttons (sold separately)
- Mounts within standard 2" x 4" (38 x 102 mm) walls
- Fully-serviceable from the front of the valve

Installation Notes

Install this product according to the installation instructions.

