

KOHLER®

Wellworth®

Two-piece elongated toilet, 1.28 gpf
K-3998-U

Features

- Two-piece design
- Elongated bowl offers added room and comfort
- Left-hand Polished Chrome trip lever
- Insuliner® tank liner minimizes condensation on the tank
- Combination consists of the K-4467-U tank and the K-4198 bowl
- Coordinates with other products in the Wellworth collection
- KOHLER's canister flush valve harnesses the natural force of gravity and optimizes flushing performance
- Eligible for consumer rebates in some municipalities
- 1.28 gpf (4.8 lpf)
- 2-1/8" (54 mm) fully glazed trapway
- Class Five® canister optimizes the flow out of the tank, harnessing gravity and the natural powerful reducing cascade of water to increase the power and effectiveness of the flush



Installation

- Standard 12" (305 mm) rough-in
- Three-bolt quick-connect installation
- Seat and supply line sold separately

Recommended Products/Accessories

K-5588 Purefresh® Deodorizing elongated toilet seat
K-4108 PureWash® E750 Elongated bidet toilet seat with remote control
K-5420 Low-Profile Bolt Caps
K-9379 Trip Lever
1023457 Wax Ring/Hardware Kit
1265114 Connector Hose
K-23726 Drain treatment

Included Components

K-4198 Elongated toilet bowl
K-4467-U Toilet tank, 1.28 gpf

Codes/Standards

ASME A112.19.2/CSA B45.1
DOE - Energy Policy Act 1992
EPA WaterSense®
IAPMO Certification

KOHLER® Toilets and Seats Limited Warranty

See website for detailed warranty information.

1-800-4KOHLER (1-800-456-4537)

Kohler Co. reserves the right to make revisions without notice to product specifications.

For the most current Specification Sheet, go to www.kohler.com USA or www.kohler.ca Canada

7-3-2024 20:39 - US

THE BOLD LOOK
OF **KOHLER®**

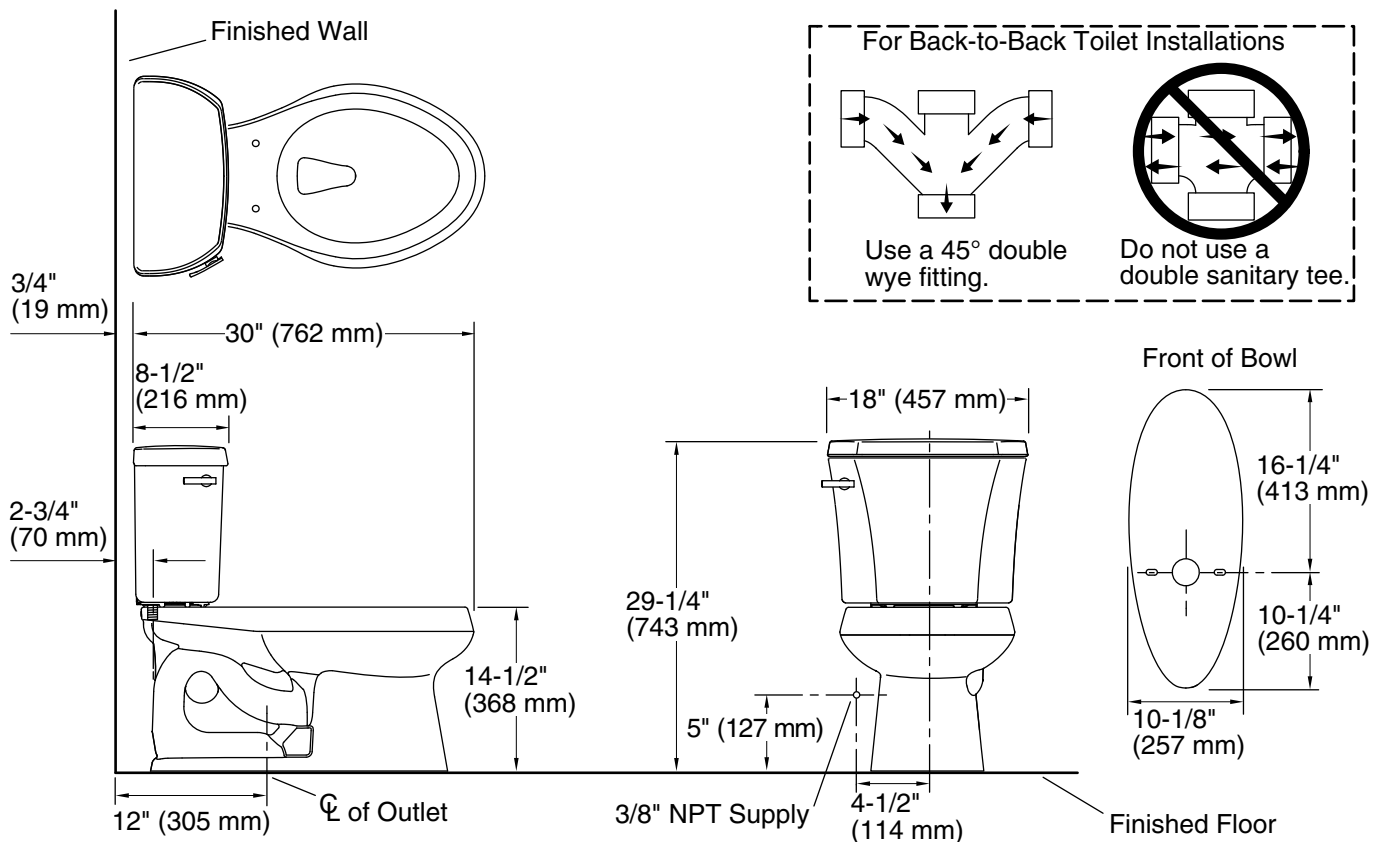

Technical Information

All product dimensions are nominal.

Toilet type:	Floor-mount
Waste Outlet:	Floor
Bowl shape:	Elongated
Flush type:	Class Five
Trap passageway:	2-1/8" (54 mm)
Water surface size:	11-1/4" x 8-1/4" (286 mm x 210 mm)
Rim to water surface:	5-1/4" (133 mm)
Rough-in:	12" (305 mm)
Seat-mounting holes:	5-1/2" (140 mm)

Notes

Install this product according to the installation instructions.

For back-to-back toilet installations: Use only a 45° double wye fitting.