

Features

- One-piece toilets integrate the tank and bowl into a seamless, easy-to-clean design
- Round-front bowl offers an ideal solution for smaller bathrooms and powder rooms
- Low-profile design
- Left-hand Polished Chrome trip lever
- Includes Reveal® Quiet-Close™ seat
- Easy-to-flush canister design requires less force to actuate than a 3" (76 mm) flapper, and has 90% less exposed seal material which resists conditions that cause wear, tear, shrinkage and swelling
- Eligible for consumer rebates in some municipalities
- 1.28 gpf (4.8 lpf)
- 2-1/8" (54 mm) fully glazed trapway

Installation

- Standard 12" (305 mm) rough-in
- Supply line sold separately

Recommended Products/Accessories

K-5420 Low-Profile Bolt Caps
K-9176 Trip Lever
1023457 Wax Ring/Hardware Kit
1265114 Connector Hose
K-23726 Drain treatment



Codes/Standards







ASME A112.19.2/CSA B45.1
DOE - Energy Policy Act 1992
EPA WaterSense®
IAPMO Certification

KOHLER® Toilets and Seats Limited Warranty

See website for detailed warranty information.

Available Colors/Finishes

Color tiles intended for reference only.

Color	Code	Description
	0	White
	96	Biscuit
	NY	Dune
	95	Ice™ Grey
	58	Thunder™ Grey
	7	Black Black™

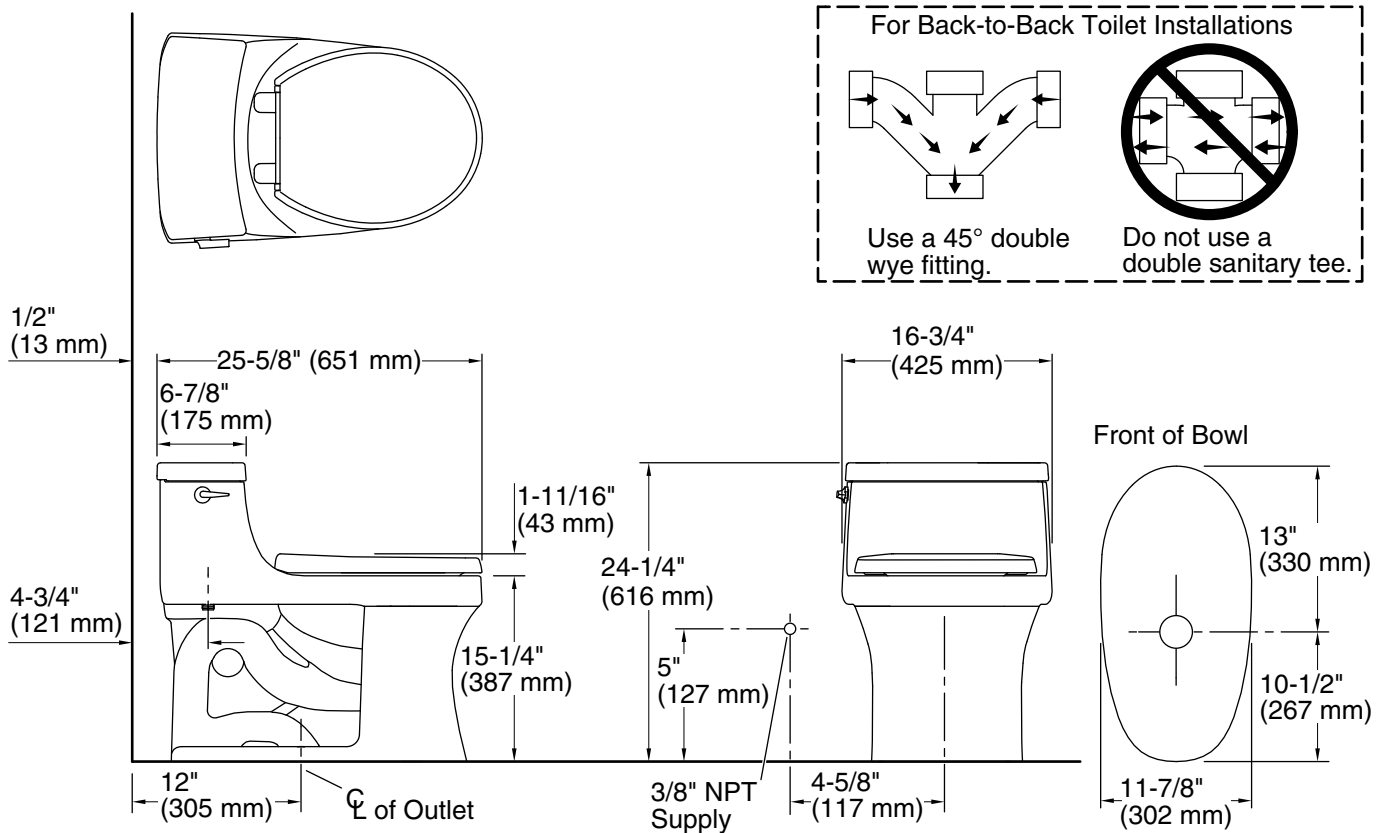

Technical Information

All product dimensions are nominal.

Toilet type:	Floor-mount
Waste Outlet:	Floor
Bowl shape:	Round-front
Flush type:	AquaPiston
Trap passageway:	2-1/8" (54 mm)
Water surface size:	9-1/4" x 6-3/4" (235 mm x 171 mm)
Rim to water surface:	6-5/16" (160 mm)
Rough-in:	12" (305 mm)
Seat-mounting holes:	5-1/2" (140 mm)

Fixture Supply Requirements

Min static pressure:	20 psi (137.9 kPa)
Max static pressure:	80 psi (551.6 kPa)

Notes

Install this product according to the installation instructions.

For back-to-back toilet installations: Use only a 45° double wye fitting.