

Features

- Column lets you customize your shower with a showerhead and handshower
- Beam shower arm makes it possible to install with extra low ceiling heights
- Slidebar bracket allows you to adjust the height and angle of the handshower
- Diverter at base of column makes for easy toggling between handshower and showerhead
- Rainhead, handshower, and hose sold separately to allow for customized components

Material

- KOHLER® finishes resist corrosion and tarnishing
- Premium metal construction for durability and reliability

Installation

- Wall-mount shower-only installation
- Installs in less than 60 minutes without changes to in-wall plumbing (subject to condition of existing installation)
- Includes an adapter that will fit with most installations but may require K-1194630, K-1187917 or K-1194302

Adapters, Rough-in and Extension Kits

1187917	Range: 0" (0 mm) - 1-3/8" (35 mm)
1194630	Range: 2-7/8" (73 mm) - 4" (102 mm)

Recommended Products/Accessories

- 1194302 Large Escutcheon/Mounting Collar Kit
- K-13688 Round 8" single-function rainhead, 2.5 gpm
- K-13689 Round 10" single-function rainhead, 2.5 gpm
- K-13692 8" single-function rainhead, 2.5 gpm
- K-13695 Square 8" single-function rainhead, 2.5 gpm
- K-23723 Faucet cleaner



ADA

Codes/Standards

ASME A112.18.1/CSA B125.1
ADA
IAPMO Certification

KOHLER® Faucet Lifetime Limited Warranty

See website for detailed warranty information.

Available Colors/Finishes

Color tiles intended for reference only.

Color	Code	Description
	CP	Polished Chrome
	SN	Vibrant® Polished Nickel
	AF	Vibrant® French Gold
	BN	Vibrant® Brushed Nickel
	BV	Vibrant® Brushed Bronze
	BL	Matte Black
	2MB	Vibrant® Brushed Moderne Brass
	TT	Vibrant Titanium

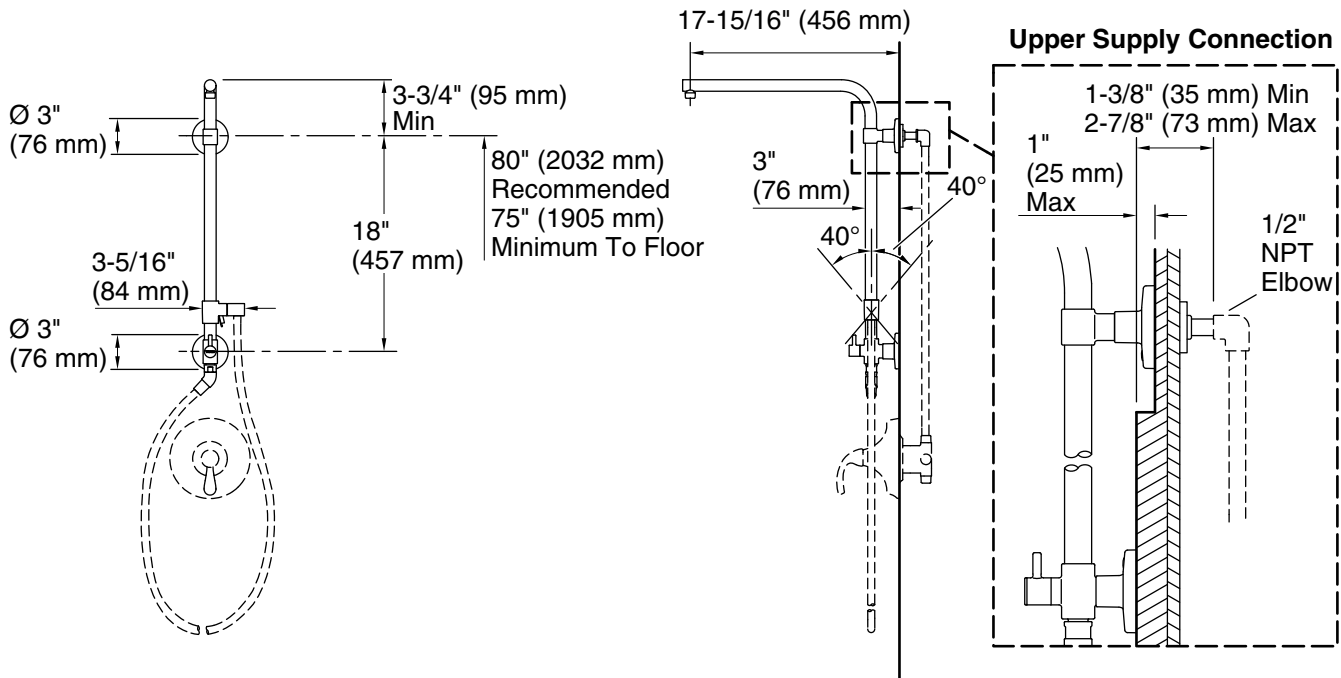

NOTE: Valve trim and hose illustrated for dimensioning only, not included in the product.

Technical Information

All product dimensions are nominal.

Drain included: No

Handshower:

Rated maximum flow: 0 gal/min (0 l/min)

Notes

Install this product according to the installation guide.

Order deep roughing-in kit 1194630 if the distance from the elbow to the finished wall surface is between $2\text{-}7/8''$ (73 mm) to $4''$ (102 mm).

Order shallow roughing-in kit 1187917 if the distance from the elbow to the finished wall surface is less than $1\text{-}3/8''$ (35 mm).

A $3''$ (76 mm) escutcheon/mounting collar is supplied to fit a $1''$ (25 mm) to $1\text{-}1/4''$ (32 mm) supply connection hole diameter. Order 1194302 large escutcheon/mounting collar kit if the supply connection hole diameter is between $1\text{-}1/4''$ (32 mm) to $2\text{-}1/4''$ (57 mm).

ADA compliant when installed to the specific requirements of these regulations.